

# INSTALLATION, OPERATING AND MAINTENANCE



**R410A**

“IN ROW” CLOSE CONTROL UNIT FOR HIGH DENSITY SYSTEMS

# R@CKCOOLAIR

## RND

DX unit with remote condenser

## 3 - 51 kW

RND\_R410A-IOM-1505-E



[www.lennoxemea.com](http://www.lennoxemea.com)



**LENNOX**



## Index

<b>1 General Description .....</b>	<b>2</b>
1.1 Structure .....	3
1.2 Application limits .....	4
1.3 Cooling circuit .....	4
1.4 Installation warnings .....	7
<b>2 Inspection / Transport / Positioning.....</b>	<b>8</b>
2.1 Inspection on receipt.....	8
2.2 Lifting and transport .....	8
2.3 Unpacking .....	8
2.4 Positioning .....	8
<b>3 Installation .....</b>	<b>9</b>
<b>4 Evacuation and Charging Operations.....</b>	<b>10</b>
4.1 Introductions .....	10
4.2 Full vacuum and charge of the unit.....	10
4.3 Evacuating a circuit “contaminated” with refrigerant.....	11
4.4 Charging positions (single point) .....	12
<b>5 Electrical Connections.....</b>	<b>12</b>
5.1 Generalities.....	12
<b>6 Operating Diagrams .....</b>	<b>13</b>
<b>7 Start-Up.....</b>	<b>14</b>
7.1 Preliminary checks.....	14
7.2 Starting operations.....	14
7.3 Checking the refrigerant charge .....	15
<b>8 Setting Operating Parameters .....</b>	<b>16</b>
8.1 Generalities.....	16
8.2 Maximum pressure switch .....	16
8.3 Minimum pressure switch .....	16
<b>9 Maintenance .....</b>	<b>17</b>
9.1 Warnings.....	17
9.2 Generalities.....	17
9.3 Repairing the cooling circuit.....	19
9.4 Tightness test.....	19
9.5 Hard vacuum and drying of cooling circuit.....	19
9.6 Recharging with refrigerant R410A.....	20
9.7 Environmental protection .....	20
<b>10.....</b>	<b>Troubleshooting21</b>

# 1 General Description

RND “CCAC” self-contained units are specially designed for installation in technological environments where a spot cooling is needed . RND units represent the state of the art between technology and design as well as all Lennox products: The depth of 1200 or 1000 mm, allows the compatibility with standard server rack: furthermore the innovative design and the high tech selected colours make RND units complementary to the last generation of IT devices. The internal design of the units in firstly made looking to efficiency and reliability but don't losing accessibility: all components, including fans, valves, compressors, electrical components, etc. can be maintained from the front or from the back. The exclusive use of primary brands components and a fully integrated development process (CAD + CAM, CAE) stands for highest possible quality level regarding efficiency, reliability, maintenance time, pre and after sales support.

RND0100

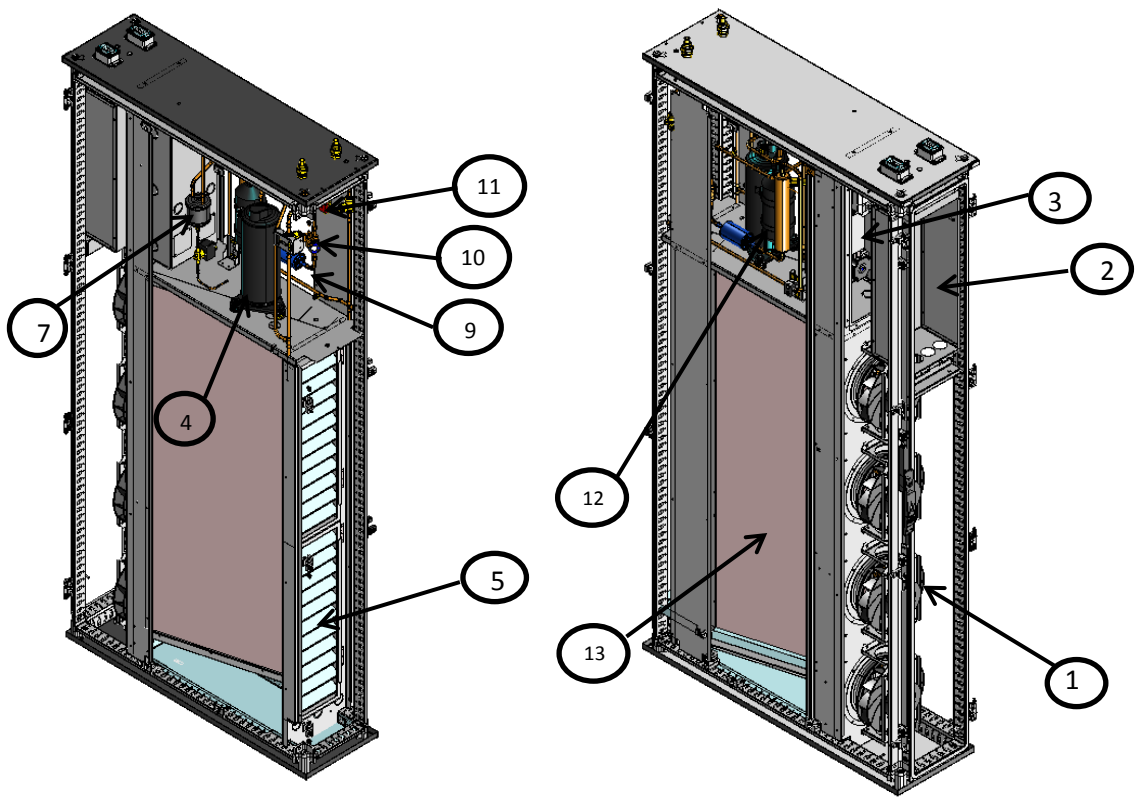

Pos.	Description	Pos.	Description
1	Radial fan	9	Dry filter
2	Electrical panel	10	Sight glass
3	Inverter	11	Expansion valve
4	BLDC compressor	12	Liquid receiver
5	Air filter	13	Evaporator
7	Oil separator		

RND0260\_0400\_0450

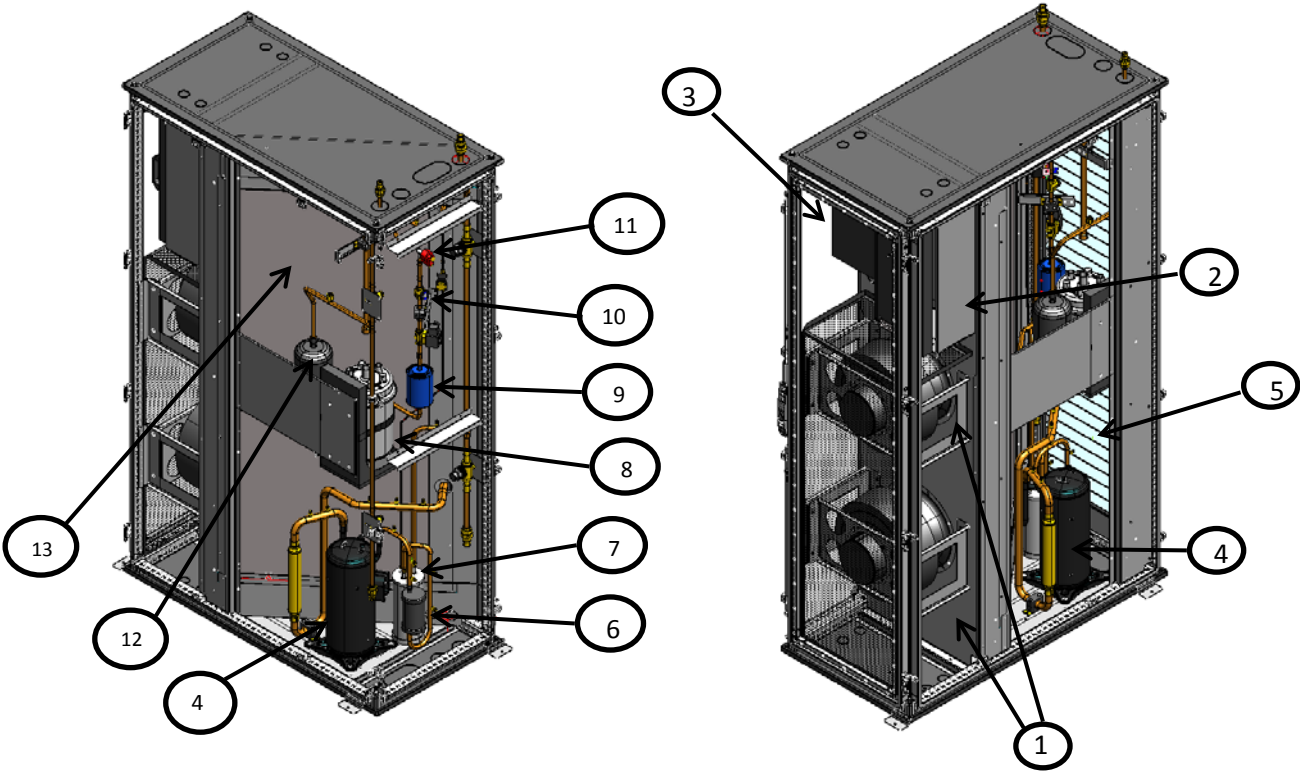

Pos.	Description	Pos.	Description
1	Radial fan	8	Umidifier
2	Electrical panel	9	Dry filter
3	Inverter	10	Sight glass
4	BLDC compressor	11	Expansion valve
5	Air filter	12	Liquid receiver
6	Silencer	13	Evaporator
7	Oil separator		

1.1 Structure

RND units are designed with a self supporting frame and all components are produced using sophisticated computer driven machines and special tools. All sheet metals are galvanized and all external panels are powder coated RAL 7016 giving to the units the image and the quality like last generation of IT devices. All fixing elements are made in stainless steel or in non corroding materials. The drain pan is made in stainless steel in order to ensure long time operation without damages.

All panels are thermally insulated with a polyurethane foam class 1 according UL 94 norms: this material, thanks to the open cells, gives good performances in sound absorption.

## 1.2 Application limits

Tab. 2 Operation limits  
Power supply limits and storage conditions

Model		RND0100	RND0260_0400_0450
Power supply		230 Vac $\pm$ 10%	400 / 3+N / 50 $\pm$ 10 %
Storage conditions	from	-10 °C / 90 % R.H.	-10 °C / 90 % R.H.
	to	+60 °C / 90 % R.H.	+60 °C / 90 % R.H.

Fig. 2 Application limits

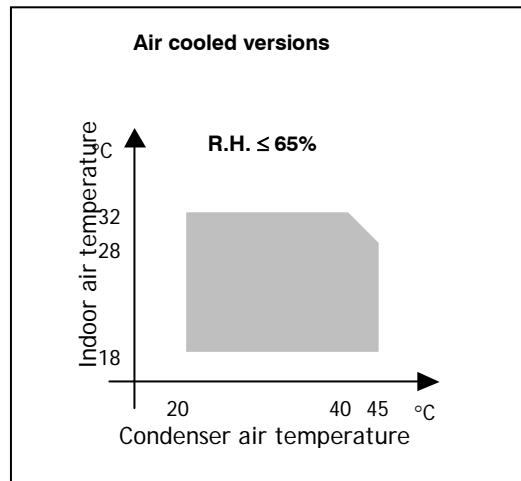

## 1.3 Cooling circuit

The entire refrigerating circuit is assembled in our production line including all pipe work and using only primary brand for components. The workers involved in the welding and pipe work process are qualified by a third part according CEE 97/23. **The units are precharged with R410A refrigerant.**

### Compressors

On **RND** units only primary brand scroll compressors in special execution for inverter application motor, are installed. Scroll compressor represent for CCAC units the best solution in terms of efficiency and reliability. The internal compression ratio is very close to the typical operating condition of CCAC giving the maximum in terms of COPs and the perfect balanced pressures at start up gives big advantages to the e\_motor in terms of reliability, mainly in this filed where frequent start up may be possible. All motors are thermally protected with an internal sensors chain: in case of overload this sensor opens without giving contacts to the connection box.

### Cooling components

- Molecular mesh activated-alumina filter dryer.
- Flow indicator with humidity indicator (indications are provided directly on the sight glass).
- High and low pressure switches.
- Schrader valves for checks and/or maintenance.

### **Electric control board**

Electric control board: The electric control board is constructed and wired in accordance with Directives 73/23/EEC and 89/336/EEC and related standards. The board may be accessed through a door after the main switch has been turned off. All the remote controls use 24 V signals powered by an insulating transformer situated on the electric control board.

- The mechanical safety devices such as the high pressure switched are of the kind that trigger directly; their efficiency will not be affected by any faults occurring in the microprocessor control circuit, in compliance with 97/23 PED.

### **Microprocessor control**

The microprocessor built into the unit allows the different operating parameters to be controlled from a set of pushbuttons situated on the electric control board:

- Switching On/Off - Modulation of compressor to maintain the temperature set point T inside the shelter.
- Alarm management : - High / Low pressure;
  - Dirty filters alarm (optional);
  - Air flow alarm.
- Alarm signalling.
- Display of operating parameters.
- RS232, RS485 serial output management (optional).
- Phase sequence error (not displayed by the mP, but prevents the compressor from starting up) (only DX).

**See microprocessor control manual for further details, also in relation to particular customer specifications.**

Fig. 3 Basic cooling circuit

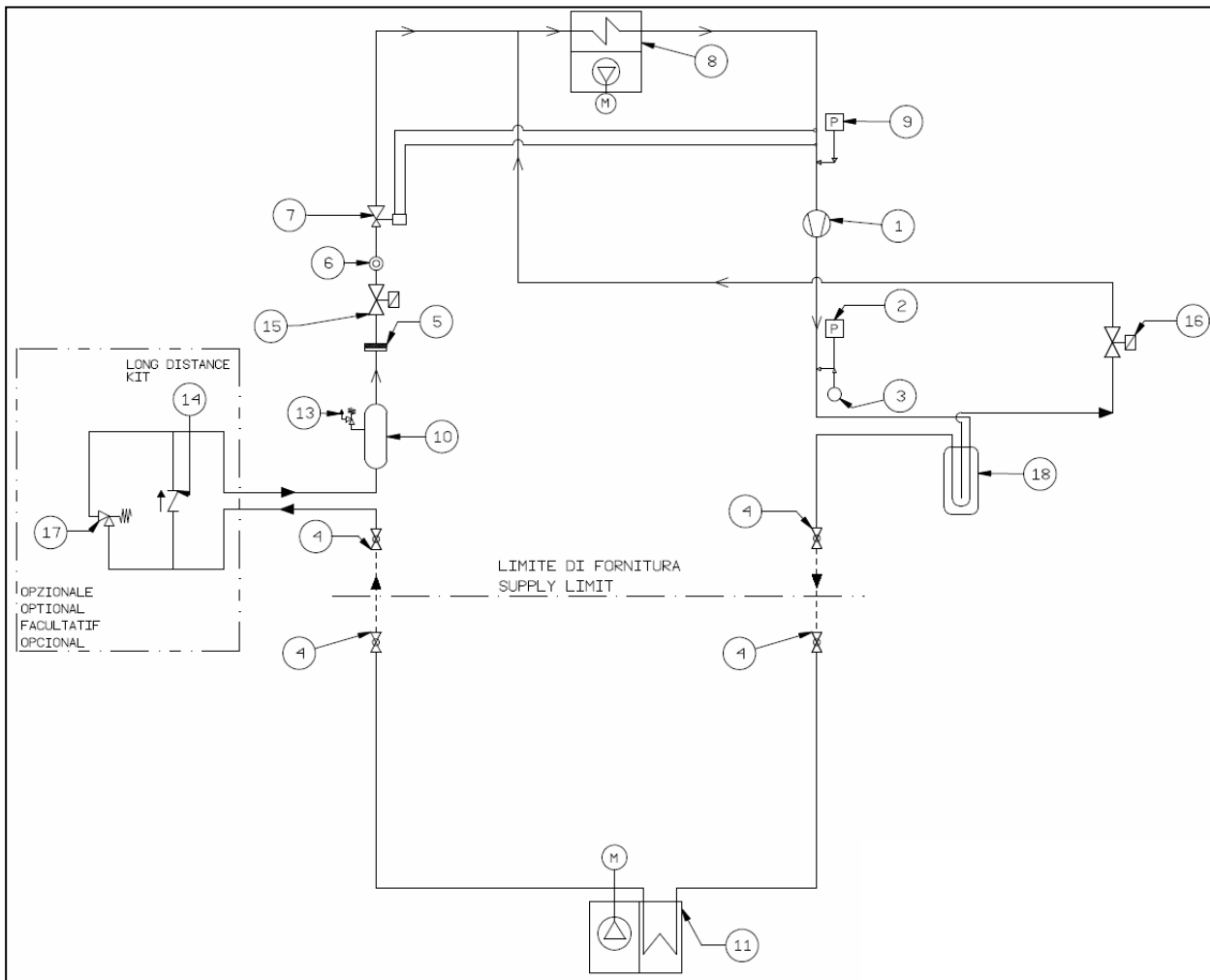

Ref.	Description	Ref.	Description
1	Inverter driven compressor	10	Liquid receiver
2	HP Pressure switch	11	Condenser
3	Pressure probe (opt.)	13	Safety valve
4	Ball valve	14	Check valve
5	Refrigerant filter	15	Solenoid valve
6	Sight glass	16	Oil solenoid valve
7	Thermostatic valve	17	Bypass valve - Long distance kit
8	Evaporator	18	Oil separator
9	LP pressure switch		



## 1.4 Installation warnings

### General rules

- When installing or servicing the unit, you must strictly follow the rules provided in this manual, comply with the directions on the units themselves and take all such precautions as are necessary.
- The fluids under pressure in the cooling circuit and the presence of electrical components may cause hazardous situations during installation and maintenance work.



**All work on the unit must be carried out by qualified personnel only, trained to do their job in accordance with current laws and regulations.**

- Failure to comply with the rules provided in this manual or any modification made to the unit without prior authorisation will result in the immediate invalidation of the warranty.



**Warning; Before performing any kind of work on the unit, make sure it has been disconnected from the power supply.**

## 2 Inspection / Transport / Positioning

### 2.1 Inspection on receipt

On receiving the unit, check that it is perfectly intact: the unit left the factory in perfect conditions; immediately report any signs of damage to the carrier and note them on the "Delivery Slip" before signing it.

**Lennox** or its agent must be promptly notified of the entity of the damage. The Customer must submit a written report describing every significant sign of damage.

### 2.2 Lifting and transport

While the unit is being unloaded and positioned, utmost care must be taken to avoid abrupt or violent manoeuvres. The unit must be handled carefully and gently; avoid using machine components as anchorages or holds and always keep it in an upright position.

The unit should be lifted using the pallet it is packed on; a transpallet or similar conveyance means should be used.



**Warning: in all lifting operations make sure that the unit is securely anchored in order to prevent accidental falling or overturning.**

### 2.3 Unpacking

The packing must be carefully removed to avoid the risk of damaging the unit. Different packing materials are used: wood, cardboard, nylon etc. It is recommended to keep them separately and deliver them to suitable waste disposal or recycling facilities in order to minimise their environmental impact.

### 2.4 Positioning

Bear in mind the following aspects when choosing the best site for installing the unit and the relative connections:

- positioning and dimensions of the coupling racks and refrigerant connections;
- location of power supply;
- solidity of the supporting floor.
- In case of side airflow (see page 15), guarantee the right suction and discharge openings on the racks sides.

It is recommended to first prepare holes in the floor for passing through the power cables and condensing water discharge.

### 3 Installation

The **RND** air-conditioning unit is suitable for all environments except aggressive ones. Do not place any obstacles near the units and make sure that the air flow is not impeded by obstacles and/or situations causing back suction.

Fig. 7 Service area

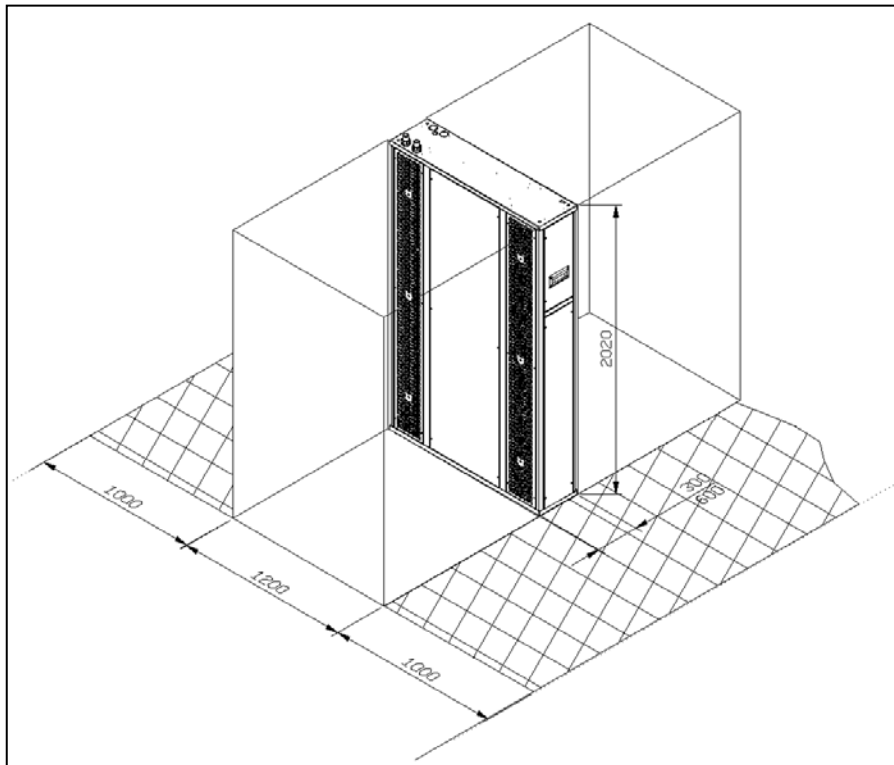

The following steps should be carried out to ensure proper installation:

- Apply a anti-vibration rubber lining between the unit and the bottom.
- Position the unit on the floor

## 4 Evacuation and Charging Operations



This type of work must be carried out by qualified personnel only trained to do their job in accordance with current laws and regulations.

### 4.1 Introductions

The contemporaneous presence of liquid and vapour requires for both to be in a state of saturation (Gibb's law), as shown in Fig. 8. In thermal equilibrated conditions, the pressure in the tank corresponds to the ambient temperature. Withdrawal of refrigerant from the tank has following effects:

- .. withdrawal of refrigerant charge: pressure drop inside the tank.
- .. pressure drop inside the tank: T drop & change of status.
- .. T drop & change of status: evaporation of part of the liquid, causing a cooling down of the liquid.
- .. cooling of liquid: thermal exchange with ambient air, further evaporation of remaining liquid; the original pressure in the tank will be restored after a certain period of time.

Fig. 8 Gibb's law diagram

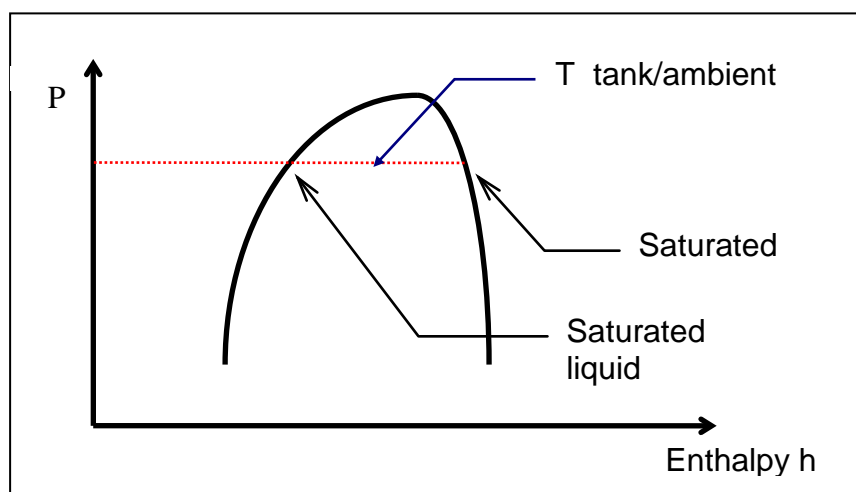

### 4.2 Full vacuum and charge of the unit

#### Vacuum cycle (unit precharged with R410A refrigerant)

After the execution of the refrigerant copper line between the indoor unit and the remote condenser, proceed with the vacuum operation connecting the pump to the unit rotalock connection. Please make sure to do not open them in order to keep the refrigerant inside the unit and do the vacuum only in the refrigerant line and inside the remote condenser.

In order to obtain a satisfactory result it is necessary to connect the vacuum pump to the pressure taps of both rotalock connections.

In general it is better to apply a "long" rather than a "hard" vacuum: reaching a low pressure too abruptly may in fact cause that any remaining humidity evaporates instantaneously, thus freezing part of it.

Fig. 9 Vacuum cycle diagram

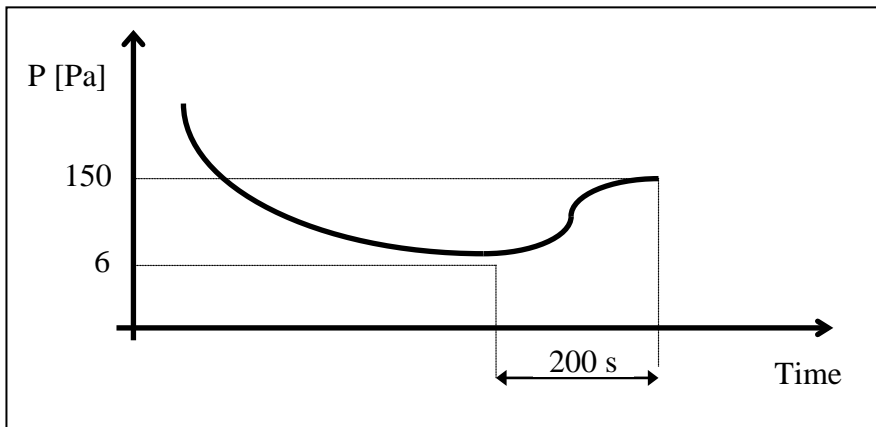

The figure Fig. 9 represents a vacuum cycle and an optimal subsequent pressure rise for the refrigeration devices we manufacture. Generally in bigger refrigeration systems or if there is a suspicion of an extensive quantity of humidity in the refrigeration circuit, the vacuum needs to be “broken” by using anhydrous nitrogen. Then the steps of evacuation need to be repeated as described before. This operation facilitates the removal of remaining and/or frozen humidity during the evacuation process.

### 4.3 Evacuating a circuit “contaminated” with refrigerant

The first step is to remove the refrigerant from the circuit. To do this a specific machine is necessary with a drying compressor in order to recover the refrigerant. All refrigerants all tend to be dissolve the in oil in the compressor sump). The “Oil” Fig. 10 illustrates a specific property (Charles’ Law) of gases, which are more soluble in liquids as the pressure increases but less soluble as the temperature increases.

Fig. 10 Charles’ law diagram

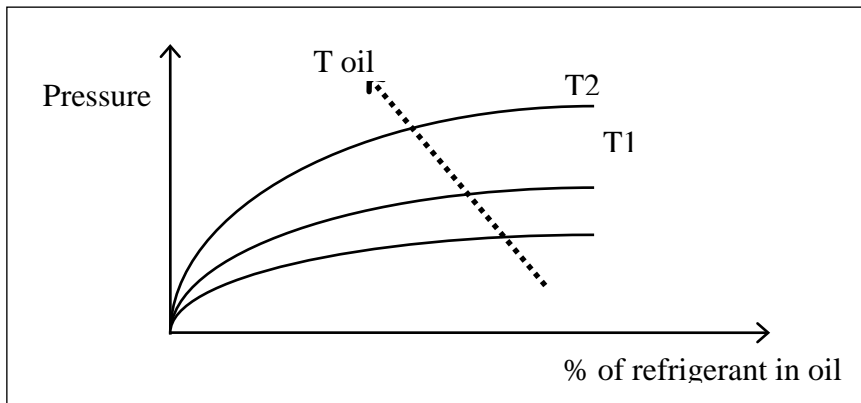

If the oil in the sump is held at a constant pressure, an increase in temperature will significantly reduce the amount of refrigerant dissolved in it, thus ensuring that the lubricating function desired is maintained. The problem of inadequate lubrication occurs if the crankcase is not duly heated, above all after seasonal interruptions when, due to the suction effect of the compressor, there is an abrupt drop in pressure inside the sump, which results in considerable evaporation of the refrigerant previously dissolved in the oil. If heating elements were not installed, this phenomenon would cause two problems:

- 1) The release of refrigerant from the cooling circuit tends to cool down the oil and thus actually creates the opposite effect by keeping more refrigerant dissolved in the oil: for this reason, it is advisable to switch on the crankcase heater during the evacuation process.
- 2) If a high % of refrigerant gets in contact with the Pirani gauge (vacuum sensor), it may “mislead” this sensitive sensor and misinterpret the value for a certain period of time. For this reason (if no machine for recovering refrigerant is available) it is nonetheless advisable to switch on the crankcase heater and to avoid full vacuum before the circuit has been adequately purged of refrigerant. The refrigerant may in fact dissolve in the oil of the vacuum pump, reducing its performance for a long time (hours).

#### 4.4 Charging positions (single point)

The best position to charge the unit is the section between the thermostatic valve and the evaporator. Take care to avoid the fixing of the thermostat bulb until the operation is completed. It is important to ensure that the valve orifice remains open in order to allow the passage of refrigerant also towards the condenser / liquid receiver.

If possible, avoid the charge of refrigerant into the suction line of the compressor as this may cause excessive dilution of the lubricant.

In case of air cooled units, in the attached "Piping Design Criteria" is described how to calculate the estimate refrigerant charge.

## 5 Electrical Connections

### 5.1 Generalities



**Before carrying out any job on electrical parts, make sure the power supply is disconnected**

Check that the mains electricity supply is compatible with the specifications (voltage, number of phases, frequency) shown on the unit rating plate. The power connection for single-phase loads is to be made with a three-pole cable and "N" wire at the centre of the star (optional: power supply w/o neutral).



**The size of the cable and line protections must conform to the specifications provided in the wiring diagram (attached to the documentation of the unit).**

The supply voltage may not undergo fluctuations exceeding  $\pm 10\%$  and the unbalance between phases must always be below 2%.



**The above operating conditions must always be complied with: failure to ensure said conditions will result in the immediate invalidation of the warranty.**

The electrical connections must be made in accordance with the information shown in the wiring diagram provided with the unit and with current and local regulations. An earth connection is **mandatory**. The installer must connect the earthing wire using the earthing terminal situated on the electric control board (yellow and green wire). The power supply to the control circuit is taken from the power line through an insulating transformer situated on the electric control board.

The control circuit is protected by suitable fuses or automatic breakers depending on the unit size.

## 6 Operating Diagrams

Changing the side, frontal and rear pannels it's possible to modify the air flow configuration as in the following pictures.

Fig. 11 Operating diagrams

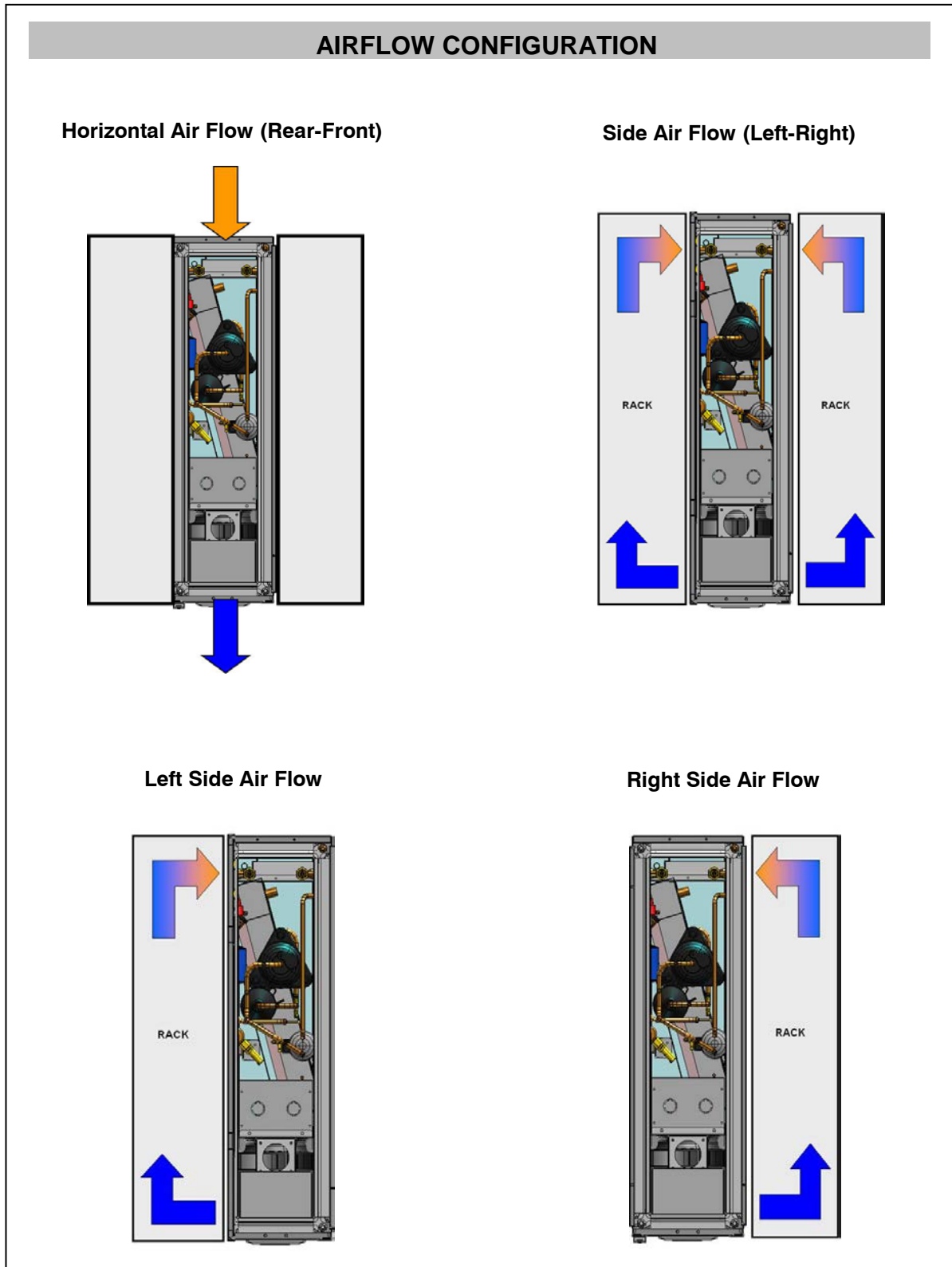

## 7 Start-Up

### 7.1 Preliminary checks

- Check that the electrical connections have been made properly and that all the terminals **are securely tightened**. This check should also be included in a periodic six-month inspection.
- Check the power supply to the crankcase heater, where present.



**The heating elements must be turned on at least 12 hours before the unit is started. They are automatically activated when the main switch is put on. Their function is to raise the T of the oil in the sump and limit the quantity of refrigerant dissolved in it.**

To verify whether the heating elements are working properly, check the lower part of the compressors: it should be warm or in any case at a temperature 10 - 15 °C higher than the ambient temperature.

Fig. 12 Charles' law diagram

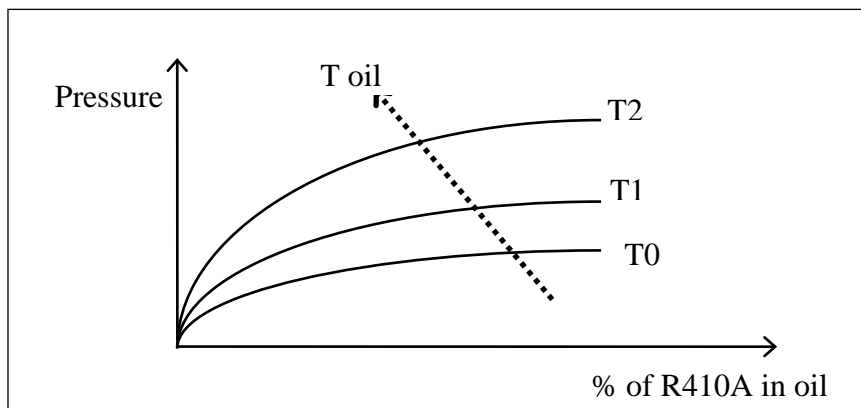

The diagram above illustrates a specific property of gases (Charles' Law), which are more soluble in liquids as the pressure increases but less soluble as the temperature increases: if the oil in the sump is held at a constant pressure, an increase in temperature will significantly reduce the amount of refrigerant dissolved in it, thus ensuring that the desired lubricating function is maintained.

### 7.2 Starting operations

Before starting the unit, turn the main switch on, select the operating mode desired from the control panel and press the "ON" button on the control panel.

**If the unit fails to start up, check if the service thermostat has been set according to the nominal values provided.**



**You should not disconnect the unit from the power supply during periods when it is inoperative but only when it is to be taken out of service for a prolonged period (e.g. at the end of the season).**



### 7.3 Checking the refrigerant charge

- After a few hours of operation, check whether the liquid level indicator has a green ring: a yellow colour indicates the presence of humidity in the circuit. In such a case the circuit must be dehumidified by qualified personnel.
- Large quantities of bubbles should not appear through the liquid level indicator. A constant passage of numerous bubbles may indicate that the refrigerant level is low and needs to be topped up.
- Make sure the overheating of the cooling fluid is limited to between 5 and 8 °C: to this end:
  - 1) read the temperature indicated by a contact thermometer placed on the condenser outlet pipe;
  - 2) read the temperature indicated on the scale of a pressure gauge connected to the liquid inlet at the condenser outlet; refer to the pressure gauge scale for the refrigerant R410A.

The degree of Sub-cooling is given by the difference between the temperatures thus determined.
- Make sure that the Sub-cooling of the cooling fluid is limited to between 3 and 5°C; to this end:
  - 1) read the temperature indicated by a contact thermometer placed on the condenser outlet pipe;
  - 2) read the temperature indicated on the scale of a pressure gauge connected to the liquid inlet at the condenser outlet; refer to the pressure gauge scale for the refrigerant R410A.



**Warning: RND units are design for R410A refrigerant.**  
**Any top-ups must be made using the same type of refrigerant. This operation is to be considered extraordinary maintenance work and must be performed by qualified personnel only**



**Warning: The refrigerant R410A requires “PVE” polyolester oil of the type and viscosity indicated on the compressor rating plate. For no reason should oil of a different type be introduced into the oil circuit.**

## 8 Setting Operating Parameters

### 8.1 Generalities

All the control devices are set and tested in the factory before the unit is dispatched. However, after the unit has been in service for a reasonable period of time you can perform a check on the control devices. The settings are shown in Tab. 5.



**All servicing of the equipment is to be considered extraordinary maintenance and may be carried out BY QUALIFIED TECHNICIANS ONLY: incorrect settings may cause serious damage to the unit and injuries to persons.**

The operating parameters and control system settings configurable by means of the microprocessor control are password protected if they have a potential impact on the integrity of the unit.

Tab. 5 Setting of control devices

Control device		Set point	Differential
Differential air pressure switch (air flow)	Pa	50	30
Differential air pressure switch (dirty filter)	Pa	70	20

*Values to be calibrated depending on the application.*

Tab. 6 Setting of control and safety devices

Control device		Activation	Differential	Resetting
Maximum pressure switch	Bar-g	38	4	Manual
Minimum pressure switch	Bar-g	2.0	1.5	Automatic
Modul. condensation control devices (DX versions)	Bar-g	18	10	
Time lapse between two compressor starts	s	480	-	-

### 8.2 Maximum pressure switch

The high pressure switch stops the compressor when the outlet pressure exceeds the set value.



**Warning: do not attempt to change the setting of the maximum pressure switch: Should the latter fail to trip in the event of a pressure increase, the pressure relief valve will open.**

The high pressure switch must be manually reset; this is possible only when the pressure falls below the differential set (see Table 6).

### 8.3 Minimum pressure switch

The low pressure switch stops the compressor when the inlet pressure falls below the set value for more than 1 second.

The switch is automatically reset when the pressure rises above the set differential (see Table 6).

## 9 Maintenance

The only operations to be performed by the user are to switch the unit on and off. All other operations are to be considered maintenance work and must thus be carried out by qualified personnel trained to do their job in accordance with current laws and regulations.

### 9.1 Warnings



**All the operations described in this chapter MUST ALWAYS BE PERFORMED BY QUALIFIED PERSONNEL ONLY.**



**Before carrying out any work on the unit or accessing internal parts, make sure you have disconnected it from the mains electricity supply.**



**The upper part and the outlet pipe of the compressor reach high temperatures. Be especially careful when working in the surrounding area with the panels off.**



**Be especially careful when working in proximity to finned coils since the 0.11 mm-thick aluminum fins can cause superficial injuries due to cuts.**



**After completing maintenance jobs, always replace the panels enclosing the units and secure them with the fastening screws provided.**

### 9.2 Generalities

To guarantee a constantly satisfactory performance over time, it is advisable to carry out routine maintenance and checks as described below. The indications below are related to standard tear and wear.

Tab. 7 Routine maintenance

Operation	Frequency
Check the efficiency of all the control and safety devices.	Once a year
Check the terminals on the electric control board and compressor terminal boards to ensure that they are securely tightened. The movable and fixed contacts of the circuit breakers must be periodically cleaned and replaced whenever they show signs of deterioration.	Once a year
Check the refrigerant level by means of the liquid level indicator.	Every 6 months
Check the efficiency of the differential air pressure switch and dirty filter differential pressure switch (option).	Every 6 months
Check the condition of the air filter and replace it if necessary.	Every 6 months
Check the humidity indicator (green = dry, yellow = humid) on the liquid level indicator; if the indicator is not green as shown on the indicator sticker (see chapter 7.3).	Every 6 months
Check the refrigerant charge (see chapter 7.3)	Every 6 months

Fig. 13 Inspecting the air filter (Downflow “CW” and “DX” version)

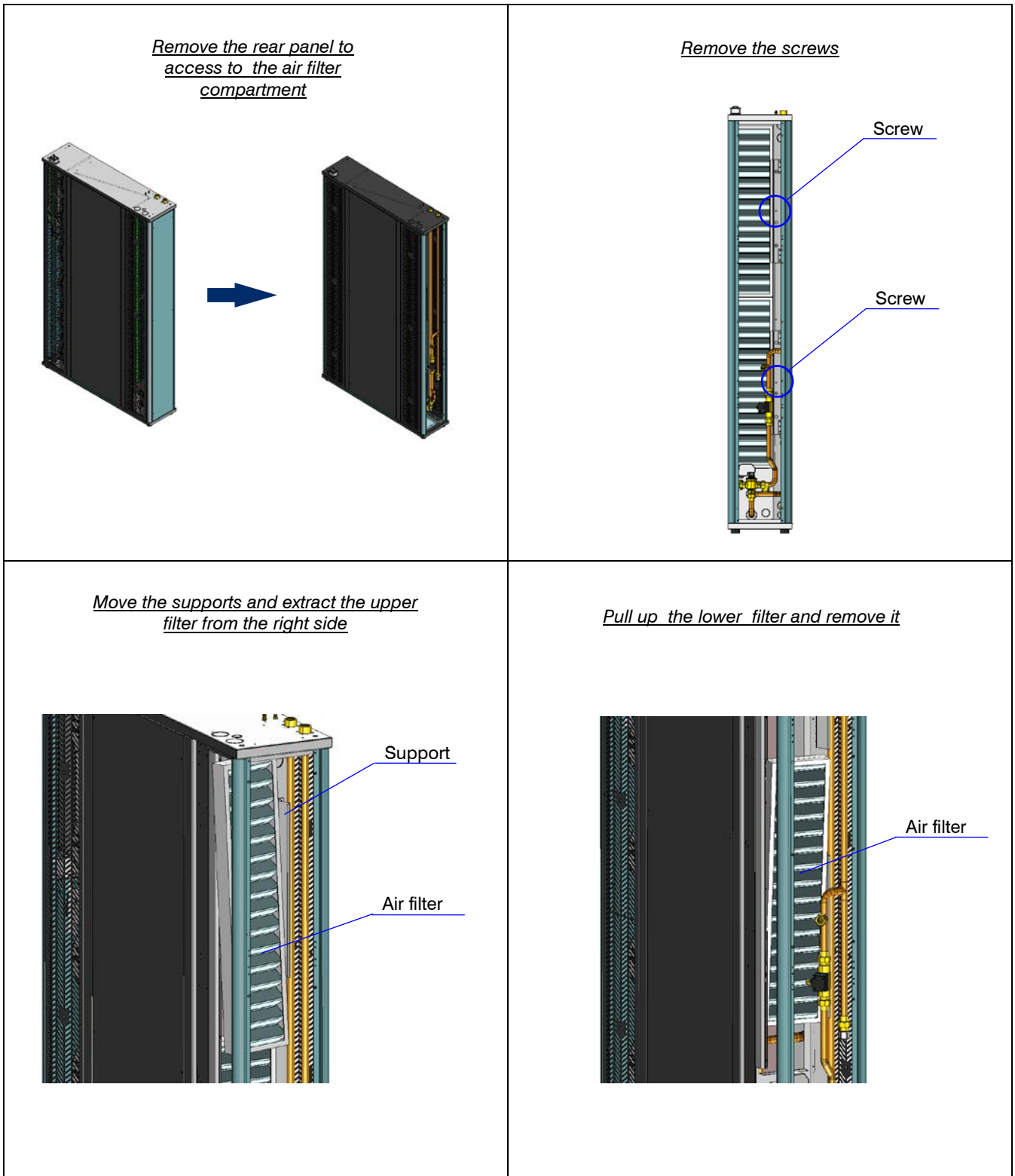

### 9.3 Repairing the cooling circuit



**While performing repairs on the cooling circuit or maintenance work on the compressors, make sure the circuit is left open for as less time as possible. Even if briefly exposed to air, ester oils tend to absorb large amounts of humidity, which results in the formation of weak acids.**

If the cooling circuit has undergone any repairs, the following operations must be carried out:

- tightness test;
- evacuation and drying of the cooling circuit;
- charging with refrigerant.



**If the system has to be drained, always recover the refrigerant present in the circuit using suitable equipment; the refrigerant should be handled exclusively in the liquid phase.**

### 9.4 Tightness test

Fill the circuit with anhydrous nitrogen supplied from a tank with a pressure-reducing valve until the pressure rises to 22 bars.



**During the pressurization phase, do not exceed a pressure of 22 bars on the compressor low pressure side.**

The presence of any leaks must be determined using special leak detectors. Should any leaks be detected during the test, empty out the circuit before repairing the leaks with suitable alloys.



**Do not use oxygen in the place of nitrogen as a test agent, since this would cause a risk of explosion.**

### 9.5 Hard vacuum and drying of cooling circuit

To achieve a hard vacuum in the cooling circuit it is necessary to use a pump capable of generating a high degree of vacuum, i.e. 150 Pa of absolute pressure with a capacity of approximately 10 m<sup>3</sup>/h. If such a pump is available, one evacuation will normally suffice to achieve an absolute pressure of 150 Pa. If there is no such vacuum pump available, or whenever the circuit has remained open for long periods of time, you are strongly recommended to adopt the triple evacuation method. This method is also recommended when there is a presence of humidity within the circuit. The vacuum pump should be connected to the inlets.

The procedure to be carried out is as follows:

- Evacuate the circuit until you reach an absolute pressure of at least 350 Pa: at this point inject nitrogen into the circuit until you reach a relative pressure of about 1 bar.
- Repeat the step described above.
- Carry out the step described above for the third time, but in this case attempting to reach the hardest vacuum possible.

Using this procedure you can easily remove up to 99% of pollutants.

## 9.6 Recharging with refrigerant R410A

- Connect the tank of refrigerant gas to the male 1/4 SAE inlet situated on the liquid line after discharging a little gas to eliminate air in the connection pipe.
- **Fill with refrigerant in liquid form** until you reach 75% of the total charge. For monobloc unit (water cooled), the correct refrigerant charge is shown in silver plate. For split units (air cooled) check the "Piping design criteria" attached to the unit documentation.
- Then connect to the inlet on the pipe between the thermostatic valve and evaporator and complete the charging process with the refrigerant **in liquid form** until no more bubbles can be seen on the liquid level indicator and the operating parameters specified in section 7.4 have been reached (see piping design criteria).



**These units are designed for the exclusive use of R410A refrigerant and should not be charge with different refrigerants without the written permission of the manufacturer.**

## 9.7 Environmental protection

The law implementing the regulations (reg. EEC 2037/00) which govern the use of ozone-depleting substances and greenhouse gases bans the dispersal of refrigerant gases in the environment and requires whoever is in their possession to recover them and, at the end of their useful life, either to return them to the dealer or take them to a suitable waste disposal facility. The refrigerant HFC R410A is not harmful to the ozone layer but is included among the substances responsible for the greenhouse effect and thus falls within the scope of the aforesaid regulations.



**Therefore, special care should be taken when carrying out maintenance work to minimize refrigerant leaks.**

## 10 Troubleshooting

On the next pages you will find a list of the most common reasons that may cause the package unit to fail or any malfunction. This causes are broken down according to easily identifiable symptoms.

FAULT	POSSIBLE CAUSES	CORRECTIVE ACTIONS
<b>The unit does not start</b>	No power supply.	Check if power is being supplied both to the primary and auxiliary circuits.
	The electronic card is cut off from the power supply.	Check the fuses.
	Alarms have been released.	Check whether any alarms are signalled on the microprocessor control panel, eliminate the causes and restart the unit.
<b>The compressor is noisy</b>	The compressor is rotating in the wrong direction.	Check the phase sequence relay. Invert the phases on the terminal board after disconnecting the unit and contact the manufacturer.
<b>Presence of abnormally high pressure</b>	Insufficient airflow through the condenser.	Check for the presence of obstructions in the condenser section ventilation circuit.
		Check whether the condenser coil surface is obstructed.
		Check the condensation control device (optional).
	Presence of air in the refrigerant circuit, as revealed by the presence of bubbles in the flow indicator also with sub-cooling values exceeding 5 °C.	Drain and pressurise the circuit and check for leaks. Evacuate slowly (for more than 3 hours) until reaching a pressure of 0.1 Pa and then recharge in the liquid phase.
	Unit overcharged, as revealed by a Sub-cooling of more than 8 °C.	Drain the circuit.
<b>Low condensation pressure</b>	Thermostatic valve and/or filter obstructed. These symptoms may also occur in the presence of an abnormally low pressure.	Check the temperatures upstream and downstream from the valve and filter and replace them if necessary.
	Transducer fault.	Replace the trasducer.
<b>Low evaporation pressure</b>	Wrong sentting of the condensation control device	Check the efficiency of the condensation control device (optional).
	Malfunctioning of thermostatic valve.	Warming the bulb with your hand, check whether the valve opens and adjust it if necessary. If it does not respond, replace it.
	Filter dryer clogged.	Pressure drops upstream and downstream from the filter should not exceed 2°C. If they do, replace the filter.
	Low condensation temperature.	Check the efficiency of the condensation control device (where present).
<b>The compressor does not start</b>	Low level of refrigerant.	Check the refrigerant level by measuring the degree of Sub-cooling; if it is below 2°C replenish the charge.
	The internal thermal protection device has tripped.	In the case of compressors equipped with a protection module, check the thermal contact. Identify the causes after restarting.
	The circuit breakers or line fuses have been tripped by a short circuit.	Pinpoint the cause by measuring the resistance of the individual windings and the insulation from the casing before restoring power.
	One of the HP or LP pressure switches has tripped.	Check on the microprocessor, eliminate the causes.
<b>Water out from the unit</b>	The phases have been inverted in the distribution compartment.	Check the phase sequence relay (only DX).
	The drain pan hole is closed.	Open the front panels, remove the sheet metal just below the e-panel (down flow units) and clean it.
	The siphon is missing.	Check for the presence and provide for a new one.
	The air flow is too high.	Reduce the fan speed up to reaching the nominal air flow.
	Unit is not perfectly level	Place correctly the unit.

## SALES OFFICES :

### BELGIUM AND LUXEMBOURG

+32 3 633 3045

### FRANCE

+33 1 64 76 23 23

### GERMANY

+49 (0) 211 950 79 60

### ITALY

+39 02 495 26 200

### NETHERLANDS

+31 332 471 800

### POLAND

+48 22 58 48 610

### PORTUGAL

+351 229 066 050

### RUSSIA

+7 495 626 56 53

### SPAIN

+34 915 401 810

### UKRAINE

+38 044 585 59 10

### UNITED KINGDOM AND IRELAND

+44 1604 669 100

### OTHER COUNTRIES :

#### LENNOX DISTRIBUTION

+33 4 72 23 20 20



Due to LENNOX EMEA ongoing commitment to quality, the specifications, ratings and dimensions are subject to change without notice and without incurring liability. Improper installation, adjustment, alteration, service or maintenance can cause property damage or personal injury. Installation and service must be performed by a qualified installer and servicing agency.



[www.lennoxemea.com](http://www.lennoxemea.com)

**RND\_R410A-IOM-1505-E**



**LENNOX**