

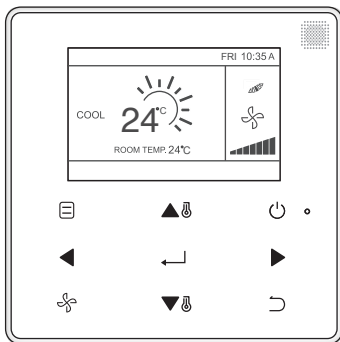

# e-Lite

## LV-CW03 | WIRED REMOTE CONTROLLER

Installation and Operation Manual





- Read this manual carefully and be sure you understand the information provided before attempting to use the product.
- Keep this manual where it is readily accessible after reading it through.
- If another user operates the product in the future, be sure to hand over this manual to the new user.



# Table of Contents

<b>Safety Precautions</b> .....	1
<b>Installation</b> .....	2
1. Accessories.....	2
2. Installation Procedure.....	3
3. Field Settings.....	14
4. Setting the IDU Address.....	23
5. Checking Error History .....	25
<b>Basic Operation</b> .....	26
1. Button Locations and Descriptions.....	26
2. Display Description.....	28
3. ON/OFF.....	31
4. Setting the Mode.....	31
5. Setting the Fan Speed.....	32
6. Setting the Temperature.....	33
7. KEY LOCK.....	34
8. Reset Filter Indicator.....	35
<b>Quick Reference</b> .....	36
Main Menu Items.....	36
<b>Menu Options</b> .....	39
1. Menu Operations.....	39

2. Setting the Louver.....	39
3. Setting TIMER CONFIGURATION.....	41
4. Setting TIMER ON.....	42
5. Setting TIMER OFF.....	43
6. Setting Schedule Configuration.....	43
7. Selecting Daily Pattern.....	44
8. Setting the Schedule.....	45
9. Setting EXTENSION.....	47
10. Setting the Date and Time.....	47
11. Setting Daylight Saving Time.....	50
12. Indoor Temperature Display.....	52
13. Locking Function.....	53
14. Setting the ECONOMY MODE.....	54
15. Setting the SILENT MODE.....	55
16. Setting the IDU LED INDICATORS.....	56
17. Setting the TEMPERATURE UNIT.....	57
18. Setting the LED INDICATOR.....	58
19. Setting the KEYPRESS TONE.....	59
20. Setting the AUX HEATER.....	60
<b>Troubleshooting.....</b>	<b>61</b>





## Safety precautions

This appliance is not intended to be used by persons, including children, with reduced physical, sensory or mental capabilities or lack of experience and knowledge, unless they are supervised or have been given instructions on how to use the appliance by a person responsible for their safety. Children should be supervised to ensure that they do not play with the appliance.

Please read these Safety Precautions carefully before installing the wired controller.

### ■ Identifier description

Identifier	Meaning
 <b>Warning</b>	Failure to follow these instructions properly may result in personal injury or loss of life.
 <b>Caution</b>	Failure to observe these instructions properly may result in property damage or personal injury, which may be serious depending on the circumstances.
 <b>Important</b>	Indicates a useful hint or additional information.



Warning

- Ask your dealer or qualified personnel to carry out installation work. Do not attempt to install the wired controller yourself. Improper installation may result in water leakage, electric shocks or fire.
- Consult your local dealer regarding relocation and reinstallation of the wired controller. Improper installation work may result in leakage, electric shocks or fire hazards.
- Install the wired controller in accordance with the instructions in this manual. Improper installation may result in water leakage, electric shocks or fire.
- Be sure to use only the specified accessories and parts for installation work. Failure to use the specified parts may result in the unit falling down, water leakage, electric shocks or fire.
- Install the wired controller on a foundation strong enough to withstand the weight of the wired controller. Insufficient strength may result in the wired controller falling down and causing injury.
- Electrical work must be performed in accordance with the relevant local and national regulations and with the instructions in this manual. Be sure to use a dedicated power supply

circuit only. Insufficient power circuit capacity and improper workmanship may result in electric shocks or fire.

- Always perform installation work with the power turned off. Touching electric parts may result in electric shock.
  - Do not disassemble, reconstruct or repair. This may result in electric shock and/or fire.
  - Make sure that all wiring is secured, the specified wires are used and that there is no strain on the terminal connections or wires. Improper connections or securing of wires may result in abnormal heat build-up or fire.
  - The choice of materials and installations must comply with the applicable national and international standards.
- 
- 



### Caution







---

- To avoid leakage and electric shock due to entry of water or insects, fill the wiring through hole with putty.
  - To avoid electric shocks, do not operate with wet hands.
  - Do not wash the wired controller with water, as this may result in electric shocks or fire.
  - When the follow me function of the remote controller is used, select the installation location while considering it should be a place:
    1. Where the average temperature in the room can be detected.
    2. Which is not exposed to direct sunlight.
    3. Which is not near a heat source.
    4. Which is not affected by the outside air or air draught due to, for example, opening/closing of doors, the air outlet of the indoor unit or the like.
- 

## Installation

### 1. Accessories

The following accessories are included.

No.	Name	Qty.	Remarks
1	Cross round head wood mounting screw	3	 $\phi 4 \times 20 \text{mm}$
2	Cross round head mounting screw	2	 M4X25mm
3	Installation & Owner's Manual	1	
4	Plastic expansion pipe	3	 $\phi 4.2 \times 28.5 \text{mm}$
5	Plastic screw bar	2	 $\phi 5 \times 16 \text{mm}$
6	Infrared cable	1	 For Non 2nd DC IDU

## 2. Installation Procedure

### 2-1 Determine where to install the remote controller

Make sure to follow the Safety Precautions when determining the location.

### 2-2 Dimension drawing

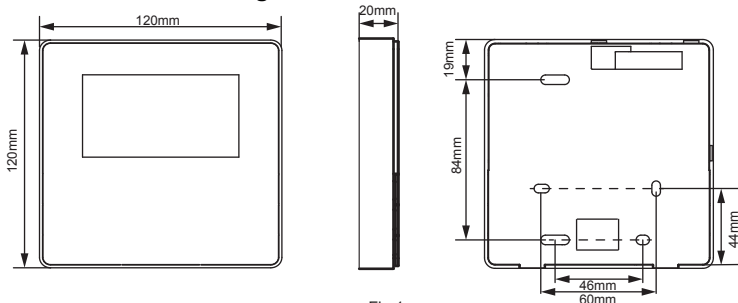

Fig.1



## 2-3 Back cover installation

2-3-1 Insert the tip of a straight head screwdriver into the buckling position at the bottom of the wired controller, and lift the screwdriver to pry open the back cover. (Pay attention to the lifting direction. Incorrect lifting with damage the back cover!) (Fig. 2)

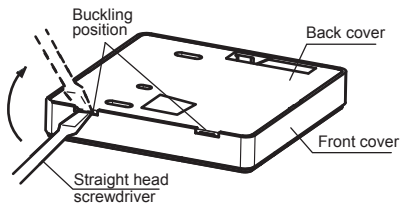

Fig.2

2-3-2 Use three M4X20 screws to mount the back cover on the wall. (Fig. 3)

Screw hole installed on the wall, use  
three  $\phi 4 \times 20$ mm

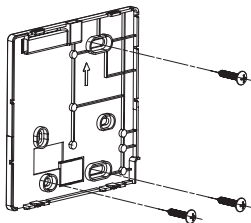

Fig.3

2-3-3 Use two M4X25 screws to install the back cover on the 86 electrical box, and use one M4X20 screw to fix to the wall. (Fig.4)

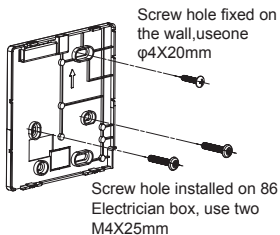

Fig.4

2-3-4 Adjust the length of the two plastic screw bars in the accessories so there is a uniform distance between the electrical box screw bar and the wall. Make sure that it is as flat as the wall when installing the screw bar to the electrical box screw bar. (Fig.5)

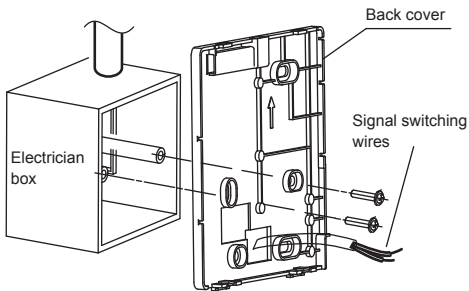

Fig.5

2-3-5 Use cross head screws to fix the wired controller bottom cover in the electric control box through the screw bar. Make sure that the wired controller bottom cover is on the same level after installation, and then install the wired controller back onto the bottom cover.

2-3-6 Fastening the screw too tightly will lead to deformation of the back cover.

## 2-4 Wire outlet

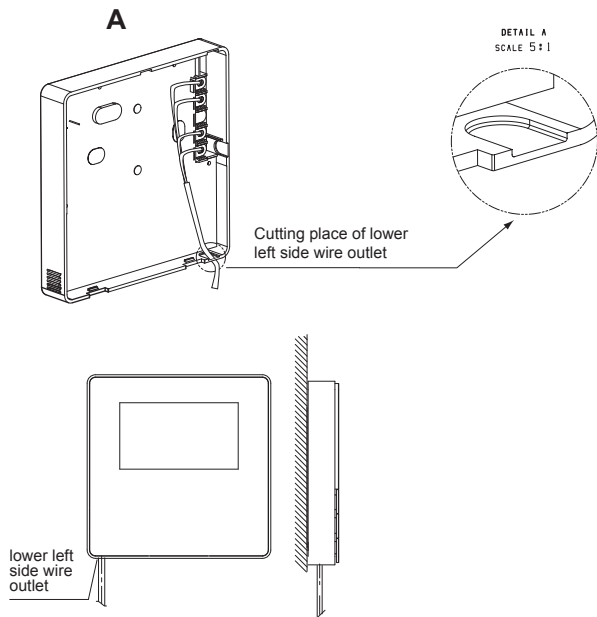

Fig.6

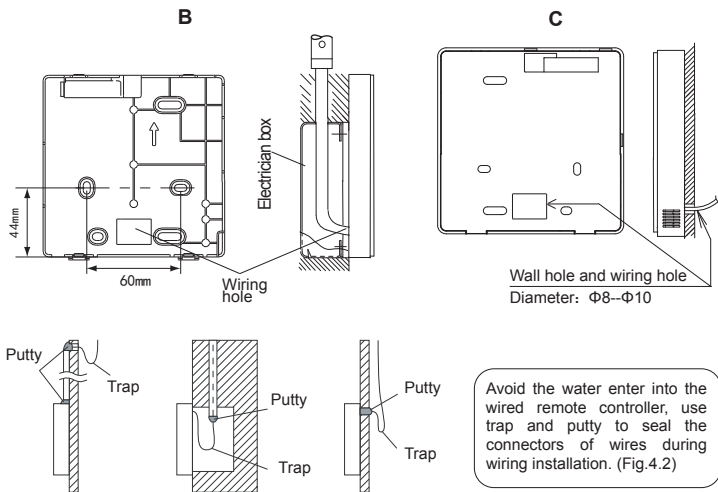

Fig.7

## 2-5 Install wires

### **i** Important

- The switch box and control wire for 2nd DC IDU are not attached.
- Do not touch the remote controller main board.

## 2-5-1 Wiring specifications

Wiring type	Shielded, 2-conductor or 4-conductor. (2nd generation DC IDU)
	Shielded, 4-conductor. (Non 2nd generation DC IDU)
Wiring size	AWG 20
Wiring length	Maximum 200 m (656 ft) for 2nd generation DC IDU (X1/X2/D1/D2 ports)
	Maximum 20 m (66 ft) for Non 2nd generation DC IDU (CN2 ports)

## 2-5-2 Wired controller connection and communication mode selection

For the 2nd generation DC IDU or Non 2nd generation DC IDU, select the connection mode according to Table-1.

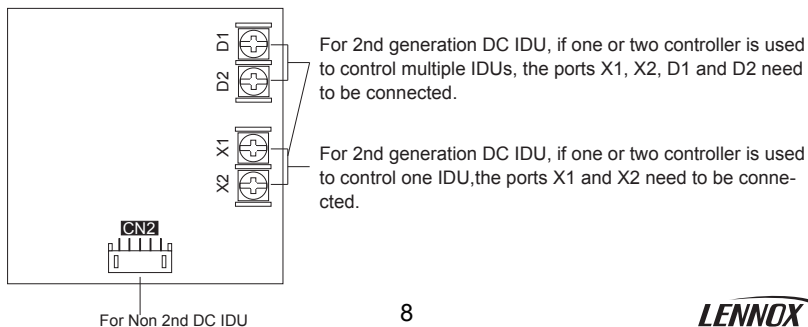

Table-1

	Connecting terminal			
	X1/X2	D1/D2	CN2	
2nd generation DC IDU	○	×	×	One or two wired controllers used to control one IDU, implementing two-way communication.
	○	○	×	Two wired controllers used to control one or multiple IDUs, implementing two-way communication.
Non 2nd generation DC IDU	×	×	○	One wired controller used to control one IDU, implementing one-way communication.

O: connected

X: not connected

2-5-3 For the 2nd generation DC IDU, the wired controller connects to the IDU X1 and X2 ports through the X1 and X2 ports. There is no polarity between X1 and X2. See Fig. 8.

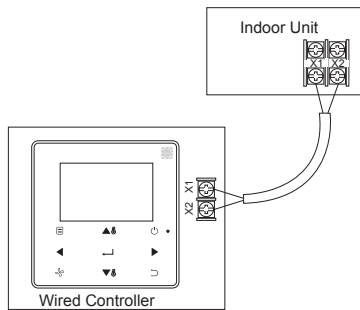

Fig.8

2-5-4 For the 2nd generation DC IDU, the main/secondary wired controller can be used to enable two wired controllers to control one IDU, and the wired controllers connect to the IDU X1 and X2 ports through the X1 and X2 ports. There is no polarity between X1 and X2. See Fig. 9

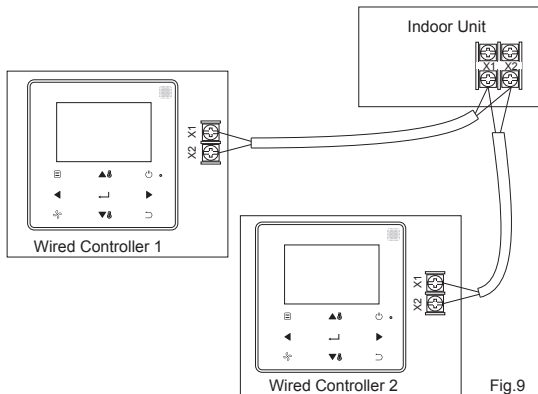

Fig.9

2-5-5 For the 2nd generation DC IDU, one or two wired controllers can also support multiple IDUs (a maximum of 16 IDUs). In this case, the wired controller and IDU need to be connected to the X1, X2, D1 and D2 ports at the same time. There is No polarity between the wired controller and X1, X2 of IDU, as well as between the wired controller and D1, D2 of IDU. The D1/D2 line sequence between the main and secondary wired controllers must be consistent. see Fig. 10 and Fig. 11.

---



### Important

---

- When the wired controller detects connection to multiple IDUs at the same time, it will send a command to disable the remote control signal receiving function of the IDU.
  - The IDU remote control reception enabling can be changed through the SERVICE menu. If the remote control reception enabling status of IDU is set, the statuses of IDUs under group control may not be consistent.
  - In group control, the wired controller is synchronized to the state of the IDU with the smallest address.
  - In group control, there will be no error prompt on the wired controller except when the IDU with the smallest address has been disconnected. Once the IDU except the smallest address IDU is powered on again, the remote send and receive functions will be automatically restored.
  - In group control, regardless if the remote send and receive functions of the IDU have been enabled in the settings, when the centralized controller/upper computer is used to update the state to that of an IDU that does not have the smallest address, this may cause the states of other IDUs under group control to be inconsistent.
-



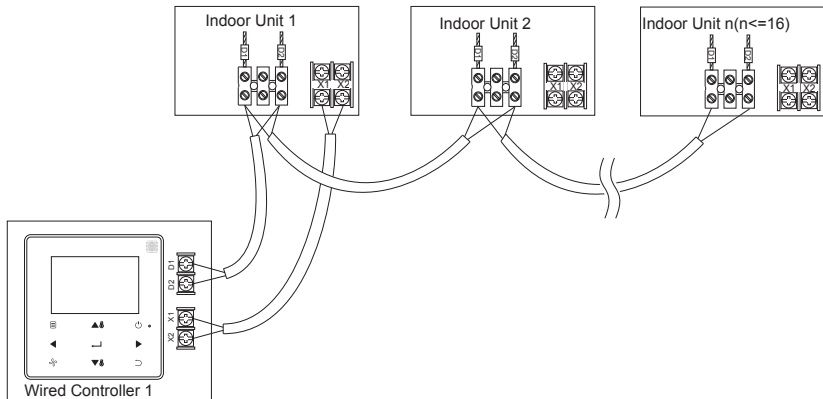

Fig. 10

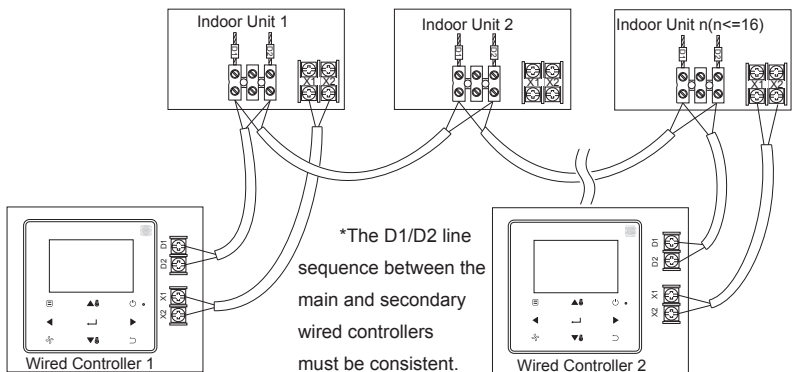

Fig. 11  
12

2-5-6 For the non 2nd generation DC IDU, the wired controller needs to be interconnected to the 5-core terminal on the IDU display panel through the CN2 port. See Fig. 12. The following standard connection cable set ① as configured for the following wired controller accessory.

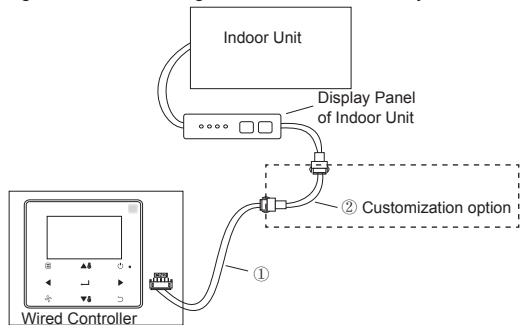

Fig.12

## 2-6 Front cover installation

After adjusting the front cover, buckle the front cover; avoid clamping the communication switching wire during installation. (Fig. 13)

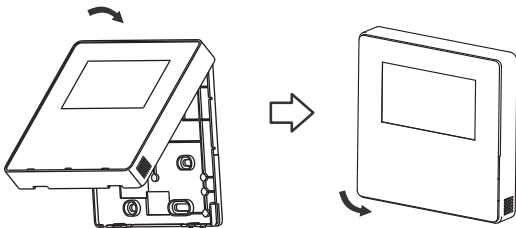

Fig.13

Correctly install the back cover and firmly buckle the front and back covers; otherwise, the front cover will fall off. (Fig.14)

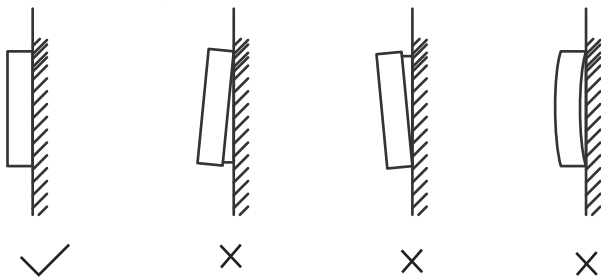
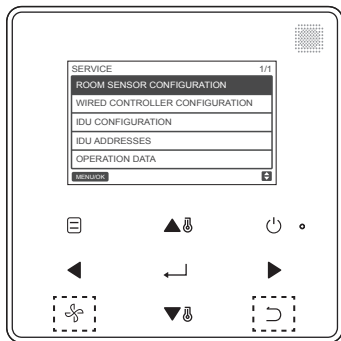

Fig.14

### Field Settings

Press and hold BACK  and FAN  at the same time for 5 seconds to enter the interface for parameter settings, as shown in Fig. 15



**Note:**

• For cooling only operations, please do corresponding settings as described .

Fig. 15 — Accessing the Parameter Settings Menu

Press TEMP UP ▲ or TEMP DOWN ▼ to move the cursor and select an entry as shown in Fig. 16, and press MENU/OK  to enter this setting.

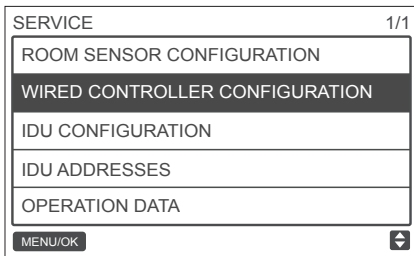

Fig. 16— Changing the Selection

Press TEMP UP ▲ or TEMP DOWN ▼ to adjust the parameter, as shown in Fig. 17

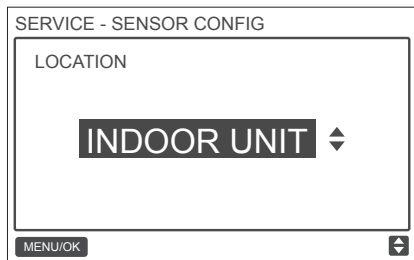

Fig. 17 — Adjusting the parameter setting



On the last menu, press MENU/OK  to confirm and return to the homepage. Press BACK  to confirm and return to the previous parameter or wait for 30 seconds to automatically exit parameter settings. For the parameter details, see Table 2 , Table 3 and Table 4

Table-2 Service menu

Level 1 Menu	Level 2 Menu	Content Settings
ROOM SENSOR CONFIGURATION	LOCATION	WIRED CONTROLLER / INDOOR UNIT(default)
	OFFSET	-5°C / -4°C / -3°C / -2°C / -1°C / 0°C(default) / 1°C / 2°C / 3°C / 4°C / 5°C -5°F / -4°F / -3°F / -2°F / -1°F / 0°F(default) / 1°F / 2°F / 3°F / 4°F / 5°F
WIRED CONTROLLER CONFIGURATION	ROLE	MAIN(default) / SECONDARY
	COOLING ONLY	ENABLED/ DISABLED(default)
	SETTING CONFIGURATION	Temperature increment(°C display only): 0.5 / 1(default)
		Fan speeds 3 / 7 (default)
	TEMP SETTING LIMITS	Cooling mode minimum: 17 ~ 30°C (62 ~ 86°F), default: 17°C(62°F)
		Heating mode maximum: 17 ~ 30°C (62 ~ 86°F), default: 30°C(86°F)
	INFRARED RECEIVER	Sets if the wired controller can receive the remote controller signal and forward the signal to the IDU ENABLED (default)/ DISABLED
AUTO RESTART	ENABLED (default)/ DISABLED	
CLEAN FILTER REMINDER PERIOD	NONE(default) / 1250HOURS / 2500HOURS / 5000 HOURS / 10000HOURS	

IDU CONFIGURATION	LOUVER	VERTICAL: ENABLED (default)/ DISABLED Sets if the vertical swing function of wired controller is valid
		HORIZONTAL: ENABLED (default)/ DISABLED Sets if the horizontal swing function of wired controller is valid
	AUX HEATER	ENABLED (default)/ DISABLED
		Activation temp: -5 ~ 20°C (23 ~ 68°F), default: 15°C (59°F) Sets so that E-heat can be started in the heating mode when the Outdoor ambient(T4) is lower than the above temperature
	TEMP COMPENSATION	Cooling mode temperature compensation: 0:0°C 1:2°C FF(default): according to the IDU settings
		Heating mode temperature compensation: 0: 6°C 1: 2°C 2: 4°C 3: 6°C 4: 0°C FF (default): according to the IDU settings
	EXV STANDBY POSITION	0: 72 steps 1: 96 steps FF(default): according to the IDU settings

	COLD DRAFT PREVENTION	<p>In heating mode the fan does not run when the indoor heat exchanger temperature is equal to or lower than:</p> <p>0: 15°C (for fresh air indoor unit: 14°C)  1: 20°C (for fresh air indoor unit: 12°C)  2: 24°C (for fresh air indoor unit: 16°C)  3: 26°C (for fresh air indoor unit: 18°C)  FF(default): according to the IDU settings</p>
	SHUTDOWN OPERATION LENGTH	<p>In heating mode when the set temperature has been reached, the fan operates in "T" minutes off / 1 minute on repeating cycle</p> <p>T=0 / 1 / 2 / 3 / FF(default)</p> <p>0: 4 minutes  1: 8 minutes  2: 12 minutes  3: 16 minutes  FF(default): according to the IDU settings</p>
	STATIC PRESSURE	<p>High static pressure, fresh air processing unit: 0~19, FF (default)</p> <p>Others: 0~9, FF (default)</p>
	AUTO MODE CHANGEOVER DELAY	<p>Minimum switching time between auto cooling and auto heating operations</p> <p>0(default): 15 minutes  1: 30 minutes  2: 60 minutes  3: 90 minutes</p>
	KEYPRESS TONE	ENABLED (default)/ DISABLED

	INFRARED RECEIVER	Sets if the IDU can receive the remote controller signal ENABLED (default)/ DISABLED
	AUTO RESTART	ENABLED (default)/ DISABLED
IDU ADDRESSES		Sets the IDU communication address (0 ~ 63#)
OPERATING DATA	ERROR CODES	Last 10 fault records (IDU, ODU, wired controller)
	ODU DATA	(Refer to appendix 1 ODU information)
	IDU DATA	(Refer to appendix 2 IDU information)
	WIRED CONTROLLER DATA	Displays the wired controller software version, T1, main or secondary wired controller, number of online IDUs, and group NO.(In group control, the group number is the smallest address among all IDUs +1)

Table-3 Secondary controller service menu

ROOM SENSOR CONFIGURATION	LOCATION	WIRED CONTROLLER / INDOOR UNIT
OPERATING DATA	ERROR CODES	Last 10 fault records (IDU, ODU, wired controller)
	ODU DATA	(Refer to appendix 1 ODU information)
	IDU DATA	(Refer to appendix 2 IDU information)
	WIRED CONTROLLER DATA	Displays the wired controller software version, T1, main or secondary wired controller, number of online IDUs, and group NO.(In group control, the group number is the smallest address among all IDUs +1)



Table-4 Service menu when the wired controller connects to the IDU through the CN2 port

Level 1 Menu	Level 2 Menu	Set parameter
ROOM SENSOR CONFIGURATION	LOCATION	WIRED CONTROLLER / INDOOR UNIT(default)
	OFFSET	-5°C/ -4°C/ -3°C/ -2°C/ -1°C/ 0°C (default) / 1°C/ 2°C/ 3°C/ 4°C / 5°C/-5°F/ -4°F/ -3°F/ -2°F/ -1°F/ 0°F(default) / 1°F/ 2°F/ 3°F/ 4°F/5°F
WIRED CONTROLLER CONFIGURATION	COOLING ONLY	ENABLED/ DISABLED(default)
	SETTING CONFIGURATION	Temperature increment (°C display only): 0.5 / 1(default)
		Fan speeds: 3 / 7 (default)
	TEMP SETTING LIMITS	Cooling mode minimum: 17 ~ 30°C(62 ~ 86°F), default: 17°C(62°F)
		HEATING MODE MAXIMUM: 17 ~ 30°C(62 ~ 86°F), default: 30°C(86°F)
	INFRARED RECEIVER	Sets if the wired controller can receive the remote controller signal and forward the signal to the IDU ENABLED (default)/ DISABLED
	AUTO RESTART	ENABLED (default)/ DISABLED
CLEAN FILTER REMINDER PERIOD	NONE(default) / 1250HOURS / 2500HOURS / 5000HOURS / 10000HOURS	
IDU ADDRESSES		Sets the IDU communication address (0 ~ 63#)

OPERATING DATA	ERROR CODES	Last 10 fault records (wired controller)
	ODU DATA	--
	IDU DATA	--
	WIRED CONTROLLER DATA	Displays the wired controller software version, T1 (wired controller)

#### Appendix 1 ODU Information

No.	Large VRF Unit	No.	Large VRF Unit
1	Unit address	20	Inverter-module heatsink Temp. B(°C)
2	Outdoor ambient(T4) temperature (°C)	21	--
3	T2/T2B average Temp.(°C)	22	--
4	Main heat exchanger pipe(T3) temperature (°C)	23	Plate heat exchanger outlet (T6B) temperature (°C)
5	Discharge Temp. of compressor A(°C)	24	Plate heat exchanger inlet (T6A) temperature (°C)
6	Discharge Temp. of compressor B(°C)	25	System discharge superheat degree
7	Inverter compressor A current(A)	26	--
8	Inverter compressor B current(A)	27	Number of working indoor units
9	--	28	--



10	Fan speed	29	Compressor discharge pressure (×0.1MPa)
11	EXVA position	30	Reserved
12	EXVB position	31	Most recent error or protection code
13	EXVC position	32	Inverter compressor A frequency
14	Operating mode	33	Inverter compressor B frequency
15	Priority mode	34	Unit capacity
16	Total capacity requirement correction of indoor unit	35	Program version No.
17	Number of outdoor units	36	Address of VIP indoor unit
18	Total capacity of outdoor unit	37	--
19	Inverter-module heatsink Temp. A(°C)	38	--

## Appendix 2 IDU Information

No.	VRF Unit
1	IDU communication address
2	Capacity (HP) of IDU
3	IDU network address
4	Set temperature Ts

5	Room temperature
6	Actual T2 indoor temperature
7	Actual T2A indoor temperature
8	Actual T2B indoor temperature
9	Fresh air unit Ta temperature
10	--
11	Target superheat degree
12	EXV degree
13	Software version No.
14	Fault code

#### 4. Setting the IDU Address

The IDU communication address can only be set when the wired controller is connected to one IDU. Press TEMP DOWN ▼ to move the cursor down, choose IDU ADDRESSES as shown in Fig. 18, and press MENU/OK  to enter this setting.

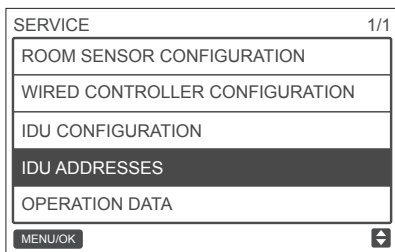

Fig. 18 - Accessing the IDU address

Press TEMP UP ▲ or TEMP DOWN ▼ to select the IDU address, and press MENU/OK to send this address to the IDU, as shown in Fig. 19.

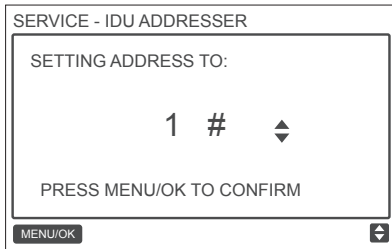



Fig. 19 - Setting the IDU address

Press BACK twice or wait 30 seconds to automatically exit the parameter settings menu.

## 5. Checking Error History

Press and hold BACK  and FAN  at the same time for 5 seconds to enter the interface for service menu, as shown in Fig. 20.

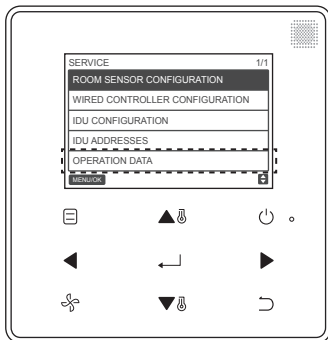





Fig. 20 - Accessing the parameter settings menu

Press TEMP DOWN  to move the cursor and select OPERATION DATA, and press MENU/OK  to enter this setting. Select ERROR CODES and press MENU/OK , as shown in Fig. 21.

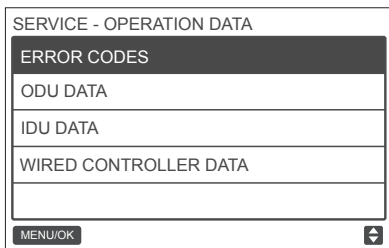

Fig. 21- Accessing ERROR CODES

Error codes and unit No. will be showed, the lash 10 events are displayed.

SERVICE-ERROR CODE					1/1
1	#	E9	09/29/17	15:30	
2	IDU 01#	E1	09/25/17	16:30	

MENU/OK

Fig.22

## Basic Operation

### 1. Button Locations and Descriptions.

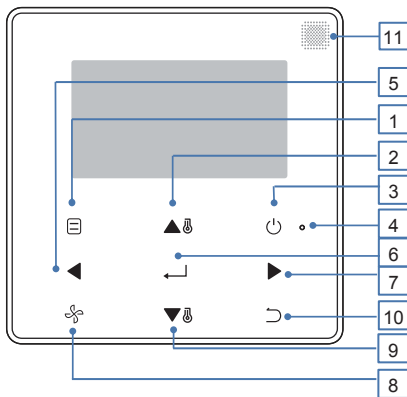

Fig.23

Table-5 Button descriptions

Button	Description
1. MODE	Selects the running mode.
2. TEMP UP button	Increases the set temperature.
3. ON/OFF button	Turns on/off IDU .
4. LED (green)	Stays solid green when the unit is powered on and blinks if there is a fault.
5. LEFT button	Selects options to the left.
6. MENU/OK button	Enters the menu/sub-menu.Confirms selection.
7. RIGHT button	Selects options to the right.
8. FAN	Selects fan speed.
9. TEMP DOWN button	Reduces the set temperature.
10. BACK button	1. Returns to the previous level. 2. Press this button for 3s to lock/unlock
11. Remote controller signal receiving window	Receives the remote controller control signal.

\* Only the backlight is turned on when the button is pressed for the first time when the wired controller backlight is off.



## 2. Display Description

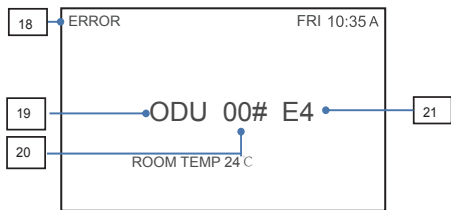
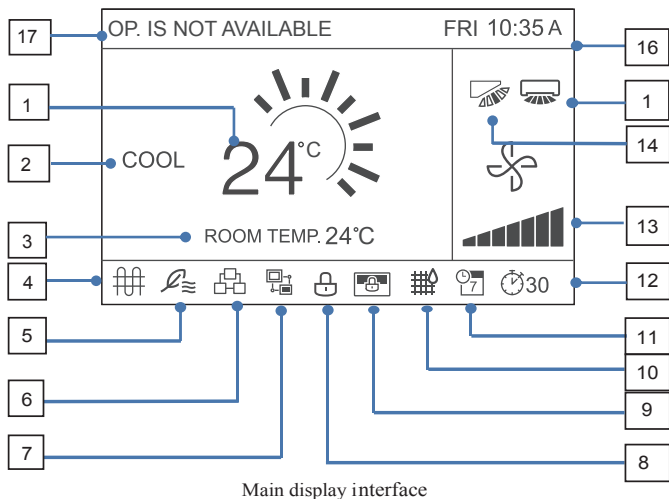

Fig.24

Table-6 Display descriptions

No.	Description
1. Set temperature	Displays the set indoor temperature.
2. Mode display	Displays the running mode set by the wired controller.
3. Room temperature display	Displays the current indoor temperature.
4.E-heat icon	Turns on when indoor unit E-heat is on.
5. Outside Air unit icon	Turns on when the wired controller connects to an outside Air unit. One wired controller can be independently connected to one outside Air unit.
6. Group control icon	Turns on when the wired controller controls multiple IDUs (max 16 IDUs).
7. Secondary wired controller icon	This is displayed when the wired controller is set to a secondary one
8. Function and key locking icon	Turns on when the wired controller locks the on/off function, mode, schedule, temperature setting, or engages the button lock.
9. Central controller/Upper computer locking icon	Turns on when the central controller/upper computer locks the IDU function and the wired controller cannot use the corresponding functions of the IDU.
10. IDU Filter Indicator	Displayed as a reminder when it is time to clean the filter or element.
11. Schedule	Turns on when the schedule is available on the wired controller.
12. EXTENSION or timer icon	Turns on when EXTENSION or timer is enabled on the wired controller.
13. Fan speed display	Displays the fan speed set by the wired controller.

14. Vertical louver	Displays louver status when the IDU supports vertical louver.
15. Horizontal louver	Displays louver status when the IDU supports horizontal louver.
16. Time display	Displays the time.
17. Invalid operation prompt	Displays for two seconds if an operation is invalid.
18. Error indication	Displays the "ERROR" message if the system is faulty.
19. Faulty IDU/ODU	"IDU" or "ODU" is displayed respectively when the IDU or ODU fails; "IDU" or "ODU" is not displayed when the wired controller fails
20. Faulty IDU/ODU address	Displays the address of the faulty unit if an error occurs in the IDU or ODU; the address is not displayed when the wired controller fails
21. Error code	Displays the error code if the system is faulty.

### 3. ON/OFF

Press ON/OFF  to turn the IDU on/off. The LED is lit when the unit is turned on. See Fig. 25.

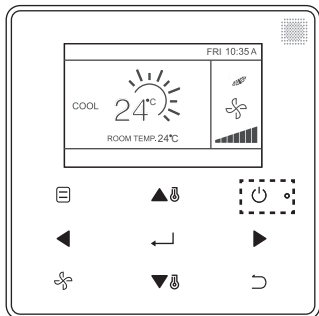

Fig. 25 - LED light display

### 4. Setting the Mode

Press MODE  to set the mode of IDU, as Shown in Fig. 26.

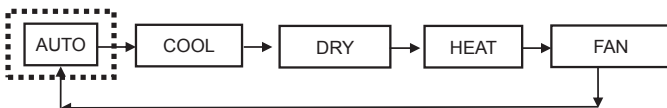

Fig. 26 Setting the Mode



---

**i** Important

---

- When the wired controller is connected to the IDU through the CN2 port, it has the above five operating modes by default.
  - When the wired controller is connected to the IDU through the X1/X2 or D1/D2 port, the operating mode that can be set for the wired controller depends on the air conditioning system. When the wired controller is connected to a heat pump system, AUTO mode is unavailable.
- 

## 5. Setting the Fan Speed

In COOL, HEAT, or FAN mode, press FAN  to change the fan speed. When the IDU supports 7 fan speeds, press the FAN  to set the fan speed circulation as shown in Figure 27.

When the IDU supports 3 fan speeds, press FAN  to set the fan speed circulation as shown in Figure 28.

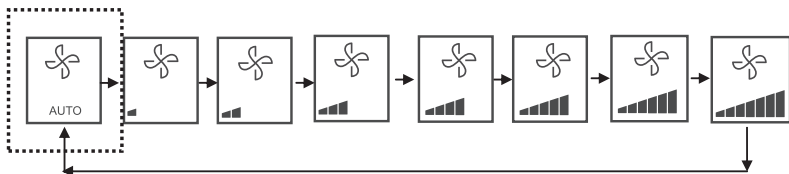

Fig. 27 The sequence of 7 fan speeds

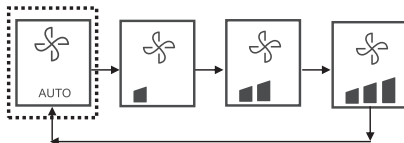

Fig. 28 The sequence of 3 fan speeds

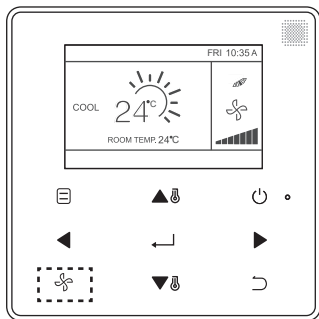

Fig. 29

## 6. Setting the Temperature

In the AUTO, COOL, DRY, or HEAT mode, press TEMP UP ▲🌀 or TEMP DOWN ▼🌀 to adjust the temperature. In AUTO mode dual set point, adjust the set temperature for cooling when the COOL set temperature is highlighted as shown in Fig. 30.

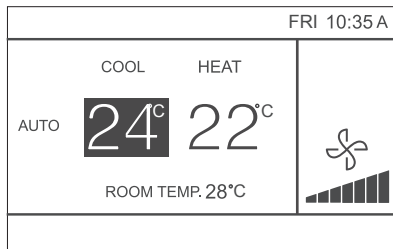

Fig. 30

Press the LEFT ◀ or RIGHT ▶ button within 10 seconds to switch between the set temperatures for cooling and heating in AUTO mode.

The set operation temperature range is 17°C~30°C (62°F~86°F).

---

 Important

---

- When the wired controller is connected to the IDU through the CN2 port, the automatic mode temperature of wired controller is set to a single set point.
- When the wired controller is connected to the IDU through the X1/X2 or D1/D2 port, the air conditioning system connected to the wired controller will decide whether the automatic mode temperature is set to single setting point or dual setting

---

## 7. KEY LOCK

Press the BACK  button for 3 seconds while the backlight is illuminated.

The  button is displayed. All the buttons are disabled.

Use the button now, and the icon,  will flicker 3 times to prompt.

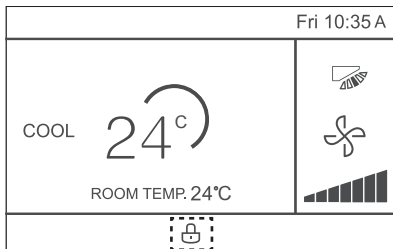





Fig. 31 - Lock icon location

To cancel the key lock mode, hold BACK  for 3 seconds while the backlight is illuminated.

## 8. Reset Filter Indicator

When it is time to clean or replace the filter, the Filter Indicator  will be displayed. Hold the fan speed button  and LEFT  at the same time for 1 second to clear the icon display.

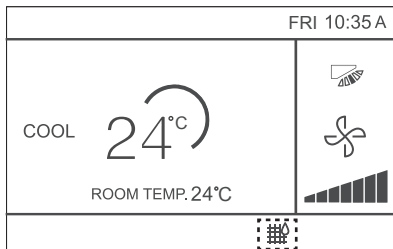

Fig.32

Wash, clean, or replace the filter or element. For details, refer to the manual provided together with the indoor unit.



## Quick Reference

The main menu provides the following items

Menu Item		Description	Reference Page
LOUVER		Used to configure airflow direction settings. <ul style="list-style-type: none"><li>● The airflow direction louver is automatically operated up and down (left and right).</li><li>● The fixed airflow directions of the vertical louver can be configured in five positions.</li></ul> * This function is not available on all models.	39
AUX HEATER		Used to set "AUTO", "ON" or "OFF"	60
ECONOMY MODE		Used to set "ON" or "OFF"	54
SILENT MODE		Used to set "ON" or "OFF"	55
IDU LED INDICATORS		Used to set the IDU LED indicator "ENABLED" or "DISABLED"	56
TEMPERATURE UNIT		Used to select whether temperature values will be displayed in Celsius or Fahrenheit.	57
TIMER	CONFIGURATION	Used to set "ENABLED" or "DISABLED" of the timer function.	41

TIMER	TIMER ON	Used to set the TIMER ON time.	42
	TIMER OFF	Used to set the TIMER OFF time.	43
SCHEDULE	CONFIGURATION	Used to enable or disable the weekly timer function.	43
	PATTERN	Day settings are selected from four patterns, i.e., "EVERYDAY", "5+2", "6+1", and "WEEKLY".	44
	SETTINGS	Set the startup time and stop time. Up to 8 actions can be set for each day.	45
	EXTENSION	Used to set delayed shutdown. Can be set in 30 minute increments from 30 to 180 minutes.	47
DATE AND TIME	DATE	Used to configure date settings and make adjustments.	47
	TIME	Used to configure time settings and make adjustments.	48
	24-HOUR FORMAT	The time can be displayed in either a 12H or 24H time format. The default time display is 24H.	49
DAYLIGHT SAVING TIME	ENABLE / DISABLE	Used to adjust the clock for daylight saving time.	50
	START		
	END		
ROOM TEMPERATURE		Used to set whether to display the indoor temperature.	52
WIRED CONTROLLER LOCK	ON / OFF	Used to set whether to lock/unlock the on/off function of wired controller	53
	MODE	Used to set whether to lock/unlock the wired controller mode setting function	

	TEMPERATURE	Used to set whether to lock/unlock the wired controller temperature setting function	53
	SCHEDULE	Used to set whether to lock/unlock the weekly timer function of wired controller	
KEYPRESS TONE		Used to set "ENABLED" or "DISABLED" of the wired controller button buzzer	59
LED INDICATOR		Used to set "ENABLED" or "DISABLED" of the wired controller LED INDICATOR	58

If two remote controllers are in control of a single indoor unit, the following menu items cannot be set in the secondary controller. In this case, the following items should be configured with the main remote controller.

- A. Temperature unit
- B. Timer function
- C. Weekly timer
- D. Daylight saving time
- E. Wired controller lock



#### Important

- There is no schedule function when the wired controller connects IDU through the CN2 port.
-

## Menu Options

### 1. Menu Operations

Press MENU/OK  to open the menu. See Fig. 33 below for an example.

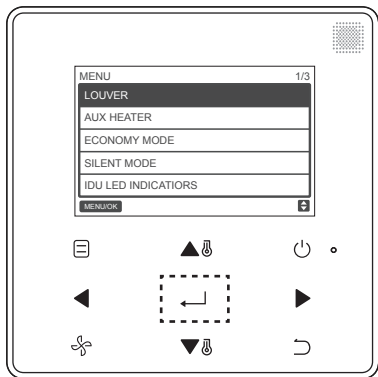







Fig. 33

Press TEMP UP  and TEMP DOWN  to select an item. Press MENU/OK  to enter. On the last level of the menu, press MENU/OK  to confirm and return to the homepage. Press BACK  to confirm and return to the previous level. If a button on the menu interface is not pressed within 30 seconds, the system will return to the homepage.

### 2. Setting the Louver

If an IDU does not have an integrated louver, the louver function will be unavailable.

Choose LOUVER on the menu interface, and press MENU/OK  to enter louver settings, as shown in Fig. 34 and Fig. 35.

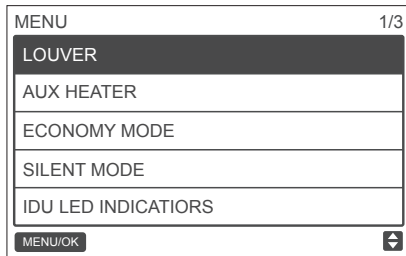

Fig. 34— Accessing the LOUVER menu

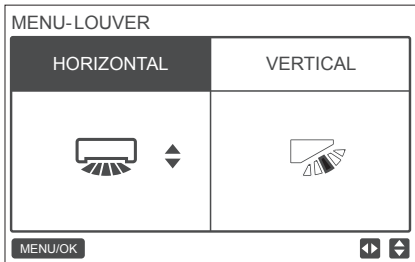

Fig. 35— LOUVER menu

Press the LEFT and RIGHT button to switch between the horizontal and vertical louver settings. Press TEMP UP ▲ and TEMP DOWN ▼ to set the louver status. If the IDU does not support horizontal swing, only vertical swing can be set. Fig. 36 and Fig. 37 show the vertical and horizontal louver sequence.

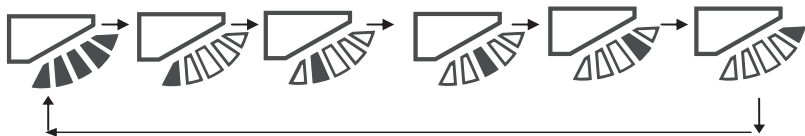

Fig. 36 - Vertical louver adjustment sequence

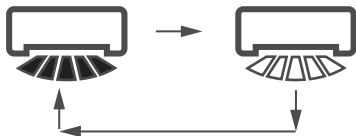

Fig.37 Horizontal louver adjustment sequence

Horizontal louver will move the louver from left to right in a predetermined pattern. This pattern is not adjustable

### 3. Setting TIMER CONFIGURATION

Choose TIMER on the menu interface, and press MENU/OK  $\leftarrow$  to enter this setting. Choose CONFIGURATION in the schedule menu, as shown below in Fig. 38, and press MENU/OK  $\leftarrow$  to enter this setting.

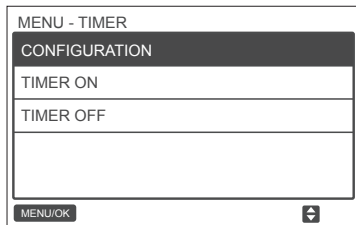

Fig. 38 - Selecting the TIMER configuration menu

Press TEMP UP  $\blacktriangle$  or TEMP DOWN  $\blacktriangledown$  to select DISABLED or ENABLE for the TIMER, as shown in Fig. 39. Press MENU/OK  $\leftarrow$  to confirm and return to the homepage. Press BACK  $\leftarrow$  to confirm and return to the previous level.

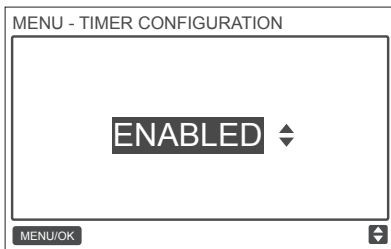

Fig. 39 - Setting TIMER CONFIGURATION

#### 4. Setting TIMER ON

Choose TIMER on the menu interface, and press MENU/OK  $\leftarrow$  to enter this setting. Choose TIMER ON in the timer menu, as shown in Fig. 40 below, and press MENU/OK  $\leftarrow$  to enter this setting.

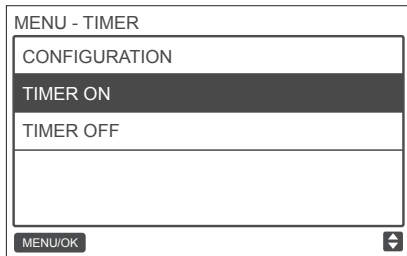

Fig. 40 - Selecting the schedule configuration menu

Press TEMP UP  $\blacktriangle$  or TEMP DOWN  $\blacktriangledown$  to select timer time, and set 0.0 hour to turn off the timer, as shown in Fig. 41. Press MENU/OK  $\leftarrow$  to confirm and return to the homepage. Press BACK to confirm and return to the previous level.

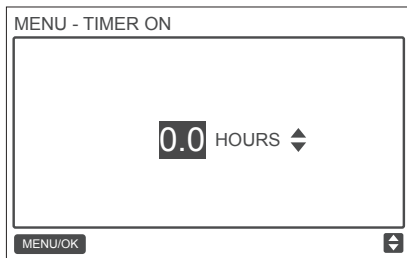

Fig. 41 - Setting TIMER ON

## 5. Setting TIMER OFF

Choose TIMER on the menu interface, and press MENU/OK  $\leftarrow$  to enter this setting.  
Choose TIMER OFF in the timer menu. For the TIMER OFF setting method, refer to TIMER ON.

## 6. Setting Schedule Configuration

Ensure that the clock is set before setting the schedule.

Choose SCHEDULE on the menu interface, and press MENU/OK  $\leftarrow$  to enter this setting.  
Choose CONFIGURATION in the schedule menu, as shown in Fig. 42, and press MENU/OK  $\leftarrow$  to enter this setting.

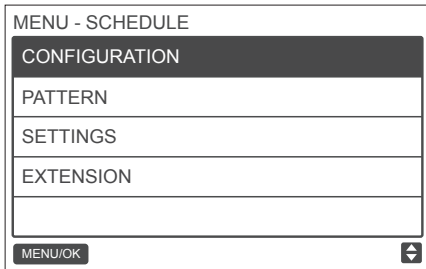



Fig. 42 - Selecting the schedule control menu



Press TEMP UP ▲ or TEMP DOWN ▼ to select DISABLED, SIMPLE or STANDARD for the weekly schedule, as shown in Fig. 43. Press MENU/OK to confirm and return to the homepage. Press BACK to confirm and return to the previous level.



SIMPLE: Requires setting the timer and time on/off.

STANDARD: Requires setting the timer, time on/off, power-on mode, fan speed and set temperature



Fig. 43 — Setting the schedule control

## 7. Selecting Daily Pattern

Choose DAILY PATTERN in the schedule menu, and press MENU/OK to open the menu. Press TEMP UP ▲ and TEMP DOWN ▼ to select DAILY PATTERN, as shown in Fig. 44.

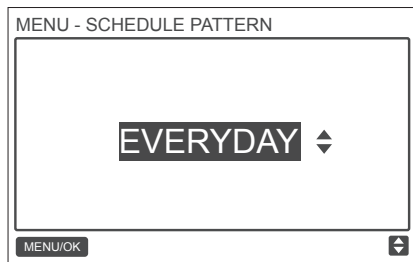

Fig. 44 — Selecting the daily pattern

Table-7 Provides the four daily patterns that can be selected.

NO.	DAILY PATTERN	DESCRIPTION
1	EVERYDAY	Sets the schedule for each day from Monday to Sunday.
2	5+2	Sets one schedule from Monday to Friday and a separate schedule for Saturday and Sunday.
3	6+1	Sets one schedule from Monday to Saturday and a separate schedule for Sunday.
4	WEEKLY	Sets one schedule from Monday to Sunday.

## 8. Setting the Schedule

Choose SETTING in the schedule menu, and press MENU/OK to open the schedule settings as shown in Fig. 45. Press the LEFT ◀ or RIGHT ▶ button to move the cursor.

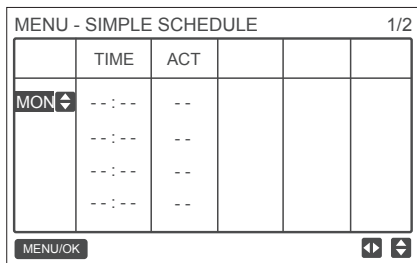

Fig. 45 — Schedule menu

Press TEMP UP ▲ and TEMP DOWN ▼ to adjust the parameters. Fig. 46 and Table 4 show the parameters that can be set in schedule settings:

MD17IU-021C

1611710001462

MENU - STANDARD SCHEDULE					1/2
	TIME	ACT	FAN	COOL	HEAT
MON ▾	08:00A	COOL	AUTO	24 C	
	--:--	--			
	--:--	--			
	--:--	--			

MENU/OK ⏪ ⏩



MENU - SIMPLE SCHEDULE					1/2
	TIME	ACT			
MON ▾	08:00A	ON			
	--:--	--			
	--:--	--			
	--:--	--			

MENU/OK ⏪ ⏩



Fig. 46 — Schedule parameters

Table-8

PARAMETER	DESCRIPTION
Week	Selects the specific day for timer settings.
TIME	Sets the timer. Up to 8 time points can be set for each day
ACT	Sets automatic on/off and the the running mode.
FAN	Sets the fan speed.
COOL	When AUTO or COOL mode is set, set the cooling temperature value.
HEAT	When AUTO or HEAT mode is set, set the heating temperature value

After setting the schedule, press MENU/OK  to confirm and return to the homepage. Press BACK  to confirm the setting and return to the previous level.

## 9. Setting EXTENSION

The EXTENSION function can be set only when the weekly schedule is enabled. The EXTENSION function will set the amount of time the settings can be extended before returning to the predetermined schedule pattern. Choose EXTENSION in the schedule menu, and press MENU/OK  to enter this setting. Press TEMP UP  or TEMP DOWN  to adjust the EXTENSION time to any one of the following: 30 min, 60 min, 90 min, 120 min, 150 min, 180 min, and NONE (cancels EXTENSION) as shown in Fig. 47.

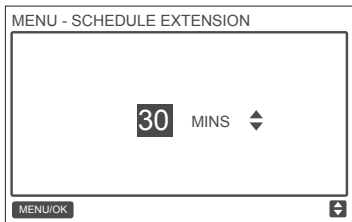



Fig. 47 — Setting the EXTENSION time

## 10. Setting the Date and Time

Choose DATE AND TIME on the menu interface, as shown in Fig. 48, and press MENU/OK  to enter this setting.

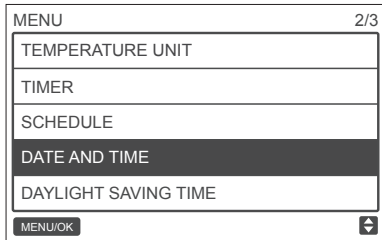

Fig. 48 — Accessing the DATE AND TIME menu

Choose DATE, as shown in Fig. 49, and press MENU/OK  $\leftarrow$  to enter this setting.

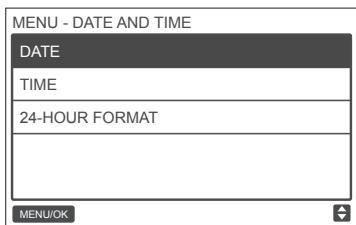

Fig. 49— Accessing the DATE menu

Press the LEFT  $\blacktriangleleft$  or RIGHT  $\blacktriangleright$  button to move the cursor, and press TEMP UP  $\blacktriangle\uparrow$  or TEMP DOWN  $\blacktriangledown\downarrow$  to set the date, as shown in Fig. 50.



Fig. 50 — Setting the date

Open the TIME setting. Press the LEFT  $\blacktriangleleft$  or RIGHT  $\blacktriangleright$  button to move the cursor, and press TEMP UP  $\blacktriangle\uparrow$  or TEMP DOWN  $\blacktriangledown\downarrow$  to set the time, as shown in Fig. 51 and Fig. 52.

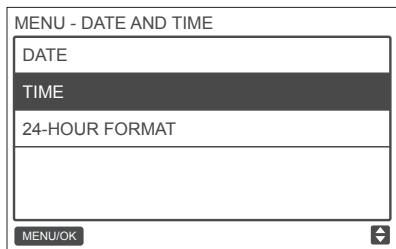



Fig. 51 - Accessing the TIME menu



Fig. 52— Setting TIME

Open USE 24-HOUR FORMAT and press TEMP UP ▲ or TEMP DOWN ▼ to select the time format, as shown in Fig. 53 and Fig. 54. When disabled, the controller will use a 12-hour format.

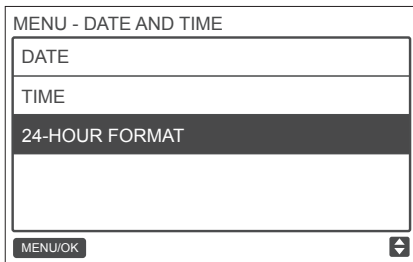

Fig. 53 — Accessing the 24-HOUR FORMAT menu

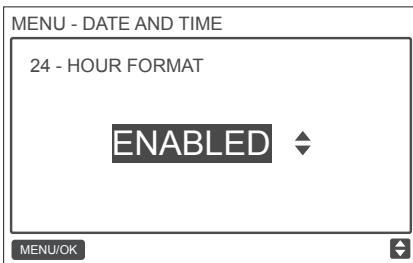



Fig. 54— Setting the 24-HOUR FORMAT

## 11. Setting Daylight Saving Time

When enabled, the clock automatically moves forward an hour at 2 a.m. on the specified start date, and it goes back an hour at 2 a.m. on the end date.

Choose DAYLIGHT SAVING TIME on the menu interface, and press MENU/OK  to enter this setting, as shown in Fig. 55.

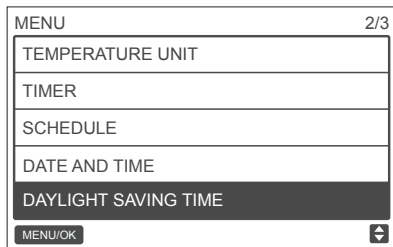



Fig. 55 - Accessing the DAYLIGHT SAVING TIME menu

**ENABLE OR DISABLE THE DAYLIGHT SAVING TIME FUNCTION** — Use the cursor to select **ENABLE/ DISABLE**, and press **MENU/OK**  to enter this setting, as shown in Fig. 56.

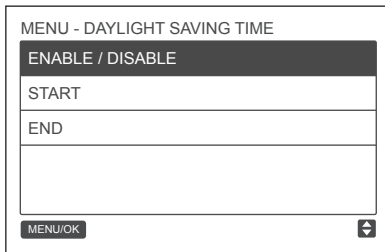







Fig. 56 — Enabling/Disabling DAYLIGHT SAVING TIME

Press **TEMP UP**  or **TEMP DOWN**  to enable or disable daylight saving time.  
**SET THE START TIME FOR DAYLIGHT SAVING** — Use the cursor to choose **START**, and press **MENU/OK** to enter this setting. Press the **LEFT**  or **RIGHT**  button to move the cursor, and press **TEMP UP**  or **TEMP DOWN**  to set the start time for daylight saving, as shown in Fig. 57



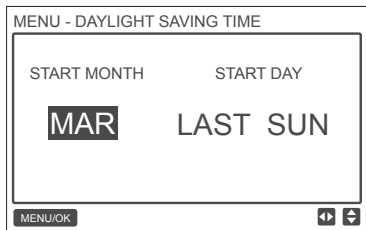







Fig. 57 — Setting the start time for daylight saving

SET THE END TIMES FOR DAYLIGHT SAVING — Use the cursor to choose END, and press MENU/OK  to enter this setting. Press the LEFT  or RIGHT  button to move the cursor, and press TEMP UP  or TEMP OWN  to set the end time for daylight saving, as shown in Fig. 58.

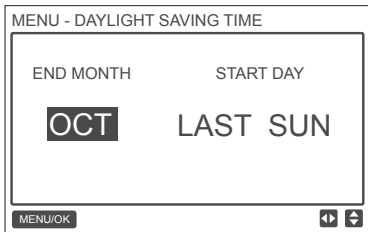

Fig. 58 — Setting end time for daylight saving

## 12. Indoor Temperature Display

When the indoor temperature display is set, the current indoor temperature will be displayed on the homepage, as shown in Fig. 59.

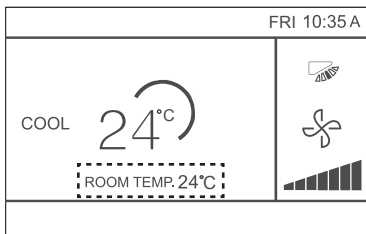



Fig. 59 - Indoor temperature display location

Choose ROOM TEMPERATURE on the menu interface as shown in Fig. 39, and press MENU/OK  to enter this setting.

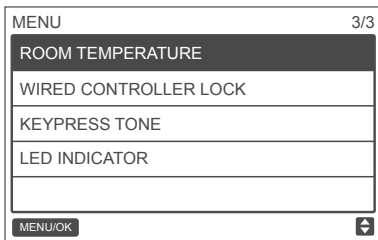





Fig. 60 - Accessing the ROOM TEMPERATURE menu

Press TEMP UP  and TEMP DOWN  to select whether to display the indoor temperature on the main screen.

### 13. Locking Function

The wired controller can lock the following functions on the IDU, so they cannot be adjusted by the user from the remote controller.

1. Power-on/off function
2. Running mode
3. Temperature setting
4. Schedule setting

Choose WIRED CONTROLLER LOCK on the menu interface as shown in Fig. 61, and press MENU/OK  to enter this setting.

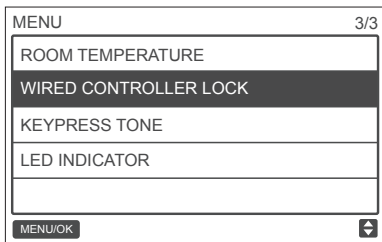

Fig. 61 - Accessing the lock menu

When ON/OFF, MODE, TEMPERATURE, or SCHEDULE are locked, the locked icon will be displayed on the homepage, as shown in Fig. 62.

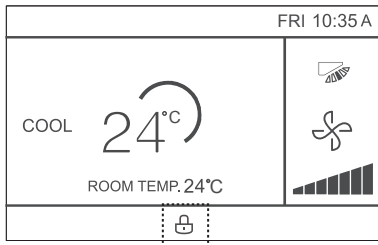



Fig. 62 — Lock icon location

The unit cannot be powered on/off using the ON/OFF button when the unit ON/OFF is locked. When you press ON/OFF  while the unit is locked, the screen will display "OP. IS NOT AVAILABLE" (invalid operation) for 2 seconds.

## 14. Setting the ECONOMY MODE

When the IDU supports ECONOMY MODE and the wired controller is ON, the ECONOMY MODE can be set for operation in the cooling and heating modes. Choose ECONOMY MODE on the menu interface as shown in Fig. 63, and press MENU/OK  to enter this setting.

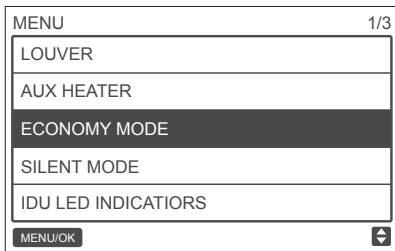

Fig. 63 — Accessing the ECONOMY MODE menu

Press TEMP UP ▲ or TEMP DOWN ▼ to set whether the economy mode is ON or OFF, as shown in Fig. 64.

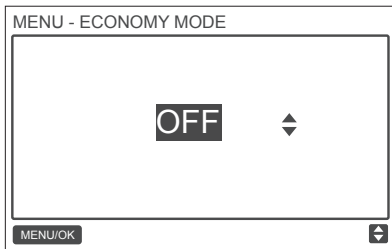

Fig. 64 — Setting ECONOMY MODE

## 15. Setting the SILENT MODE

When the IDU supports silent mode and the wired controller is ON, SILENT MODE can be set for operation in the cooling mode and heating mode.

Choose SILENT MODE on the menu interface as shown in Fig. 65, and press MENU/OK to enter this setting.

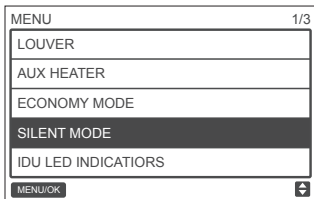

Fig. 65 — Accessing the SILENT MODE menu

Press TEMP UP ▲ or TEMP DOWN ▼ to set whether the silent mode is ON or OFF, as shown in Fig. 66.

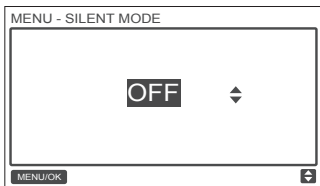

Fig. 66 — Setting SILENT MODE

## 16. Setting the IDU LED INDICATORS

When the IDU LED setting is enabled, the LED turns on when the IDU starts.

Choose IDU LED INDICATORS on the menu interface as shown in Fig. 67, and press MENU/OK ← to enter this setting.

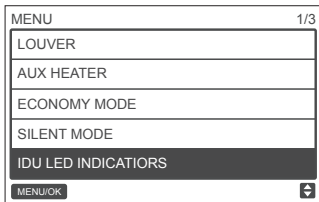

Fig. 67 — Accessing the IDU LED INDICATORS menu

Press TEMP UP ▲ or TEMP DOWN ▼ to set whether the LED is ENABLED or DISABLED as shown in Fig. 68.

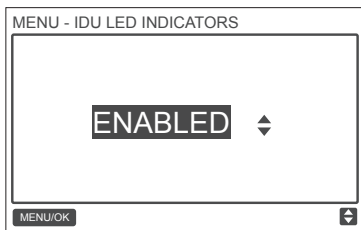

Fig. 68 — Setting the IDU LED INDICATORS

## 17. Setting the TEMPERATURE UNIT

Sets the temperature unit displayed on the wired controller

Choose TEMPERATURE UNIT on the menu interface, as shown in Fig. 69, and press MENU/OK ↵ to enter this setting.

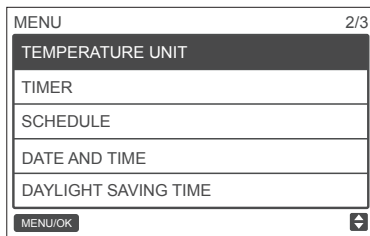

Fig. 69 — Accessing the TEMPERATURE UNIT menu

Press TEMP UP ▲ or TEMP DOWN ▼ to select CELSIUS or FAHRENHEIT, as shown in Fig. 70.

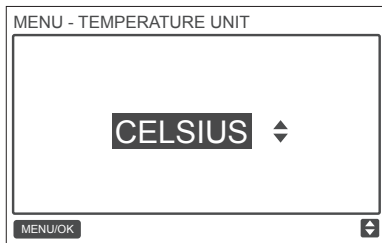



Fig. 70 — Setting the TEMPERATURE UNIT display

## 18. Setting the LED INDICATOR

When the LED setting is on, the LED turns on when the IDU starts. The LED blinks if a system fault occurs. Choose LED INDICATOR on the menu interface as shown in Fig. 71, and press MENU/OK  to enter this setting.

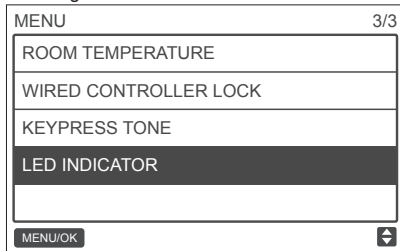



Fig. 71 — Accessing the LED INDICATOR menu

Press TEMP UP  or TEMP DOWN  to set whether the LED is ENABLED or DISABLED, as shown in Fig. 72.

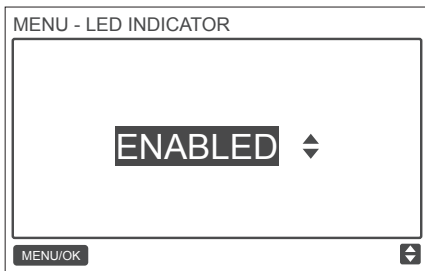

Fig. 72 — Setting LED INDICATOR

## 19. Setting the KEYPRESS TONE

Choose KEYPRESS TONE on the menu interface as shown in Fig. 73, and press MENU/OK to enter this setting.

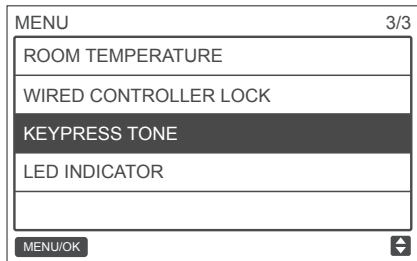



Fig. 73 — Accessing the KEYPRESS TONE menu

Press TEMP UP ▲ or TEMP DOWN ▼ to set the KEYPRESS TONE ENABLED or DISABLED, as shown in Fig. 74.



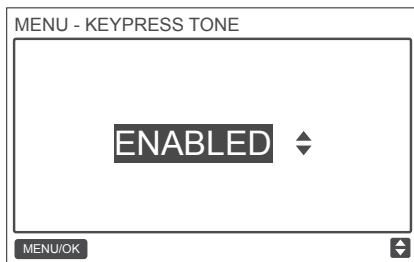



Fig. 74 — Setting KEYPRESS TONE

## 20. Setting the AUX HEATER

When the IDU supports E-heat and the wired controller is ON, the AUX HEATER function can be set in the heating modes. Choose AUX HEATER on the menu interface as shown in Fig. 75, and press MENU/OK  to enter this setting.

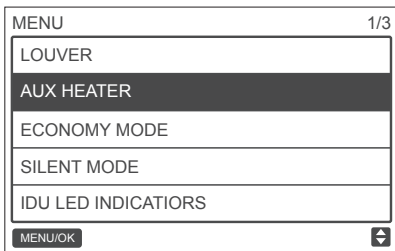



Fig. 75 — Accessing the ECONOMY MODE menu

Press TEMP UP  or TEMP DOWN  to set whether the aux heater is AUTO, ON or OFF, as shown in Fig. 76.

When sets to AUTO, the on / off state of E-heat depends on AUX HEATER activation temp setting in service menu (service menu - IDU CONFIGURATION - AUX HEATER, P17) and the operation

state of IDU and ODU (heating mode, room temp, etc.). When sets to ON, the on / off state of E-heat depends on the operation state of IDU and ODU, despite of AUX HEATER activation temp setting in service menu.

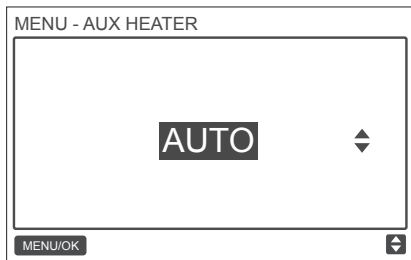

Fig. 76 — Setting AUX HEATER

## Troubleshooting

Error code and description	POSSIBLE CAUSES	POSSIBLE SOLUTIONS
No display on the wired controller	IDU not powered on	Power on the IDU.
	Wired controller connection error	First power off the IDU, and then check if the wired controller connection is correct; for the connection requirements, see the P__ WIRING part.
	Wired controller damaged	Replace the wired controller.
	Power supply failure of the IDU board	Replace the IDU board.

Error code and description	POSSIBLE CAUSES	POSSIBLE SOLUTIONS
E9: Wired controller and IDU communication fault	No address set for the IDU or IDU address duplicated	Set an address for the IDU; duplicated IDU addresses are not allowed in the same system.
	Main/secondary wired controller not set when two wired controllers control one or multiple IDUs	Set one wired controller to secondary wired controller.
	The D1/D2 line sequence of secondary wired controller is inconsistent with that of the main wired controller	Exchange the D1/D2 line sequence of secondary wired controller.
	Wired controller damaged	Replace the wired controller.
	IDU board fault	Replace the IDU board.
F7: Wired controller EEPROM fault	EEPROM data error	Press "MODE" + "MENU" + "TEMP UP" + "TEMP DOWN" for more than 3 seconds to reset the wired controller until the default status appears.
	Wired controller damaged	Replace the wired controller.
For any "Group", the number of IDUs may not be consistent with the actual number of connected IDUs.	D1/D2 communication wiring error or bad contact in individual IDU.	Check and adjust the D1/D2 communication line
	IDU address has not been set or duplicate address.	Set the IDU address. No duplicate IDU addresses in the same system.
	Main-secondary wired controllers have not been set.	Set one wired controller to be the secondary wired controller.
	Board failure in individual IDU.	Replace the board of affected IDU.

Thank you very much for purchasing our product.  
Before using your air conditioner, please read this manual carefully and keep it for future reference.

Due to LENNOX EMEA ongoing commitment to quality, the specifications, ratings and dimensions are subject to change without notice and without incurring liability. Improper installation, adjustment, alteration, service or maintenance can cause property damage or personal injury.  
Installation and service must be performed by a qualified installer and servicing agency.



brand of LENNOX EMEA

**Headquarters LENNOX EMEA**

7 rue des Albatros - Z.I. Les Meurières, 69780 Mions - France  
+33 (0) 810 502 502  
[www.lennoxemea.com](http://www.lennoxemea.com)

