

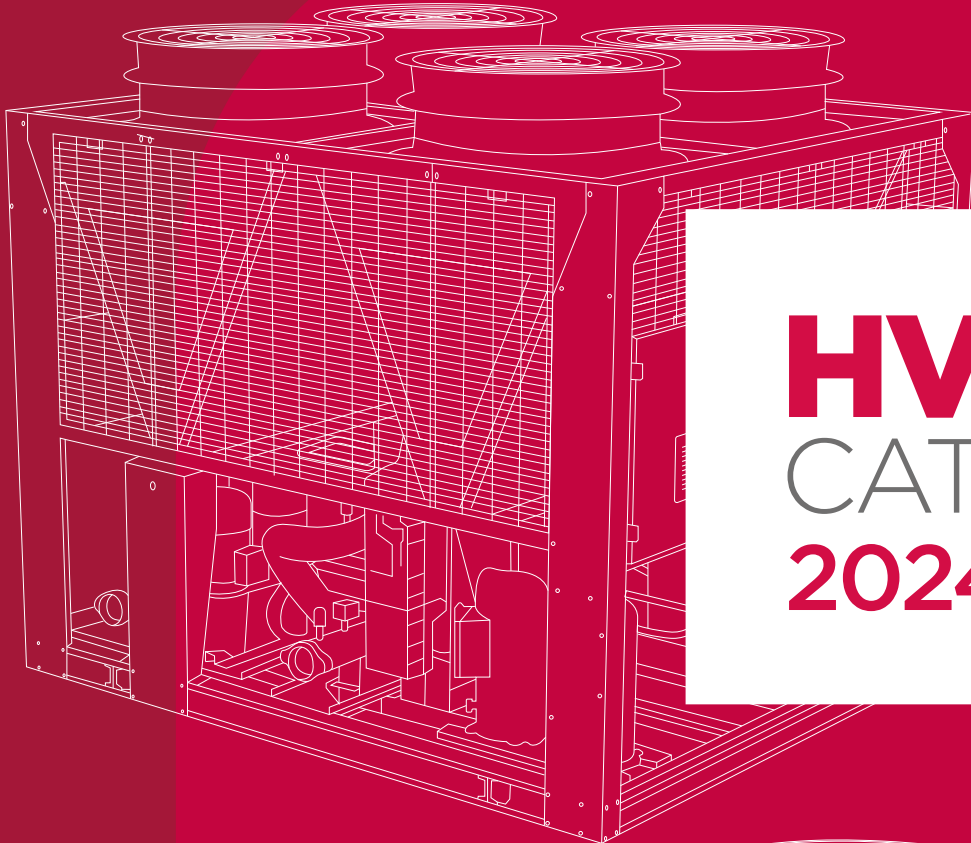

AIR CONDITIONING & HEATING
AIR TREATMENT & VENTILATION
CONTROL & SUPERVISION



HVAC

CATALOGUE

2024

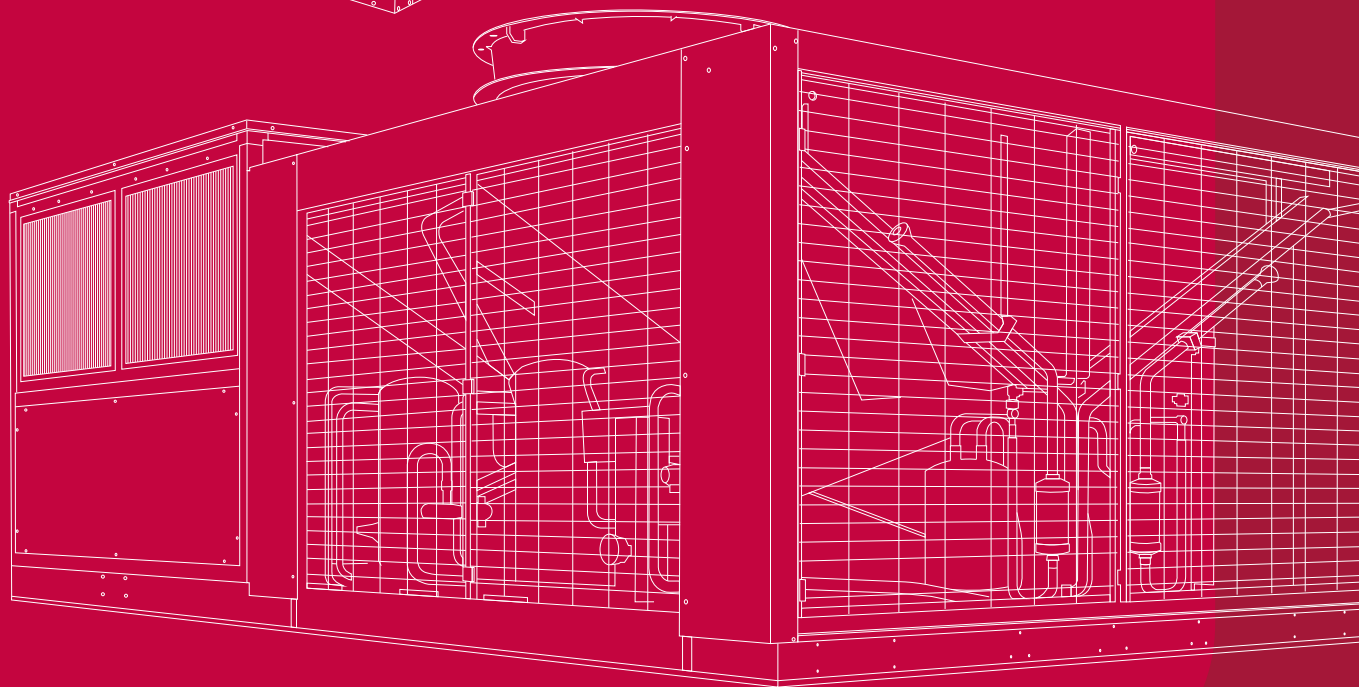





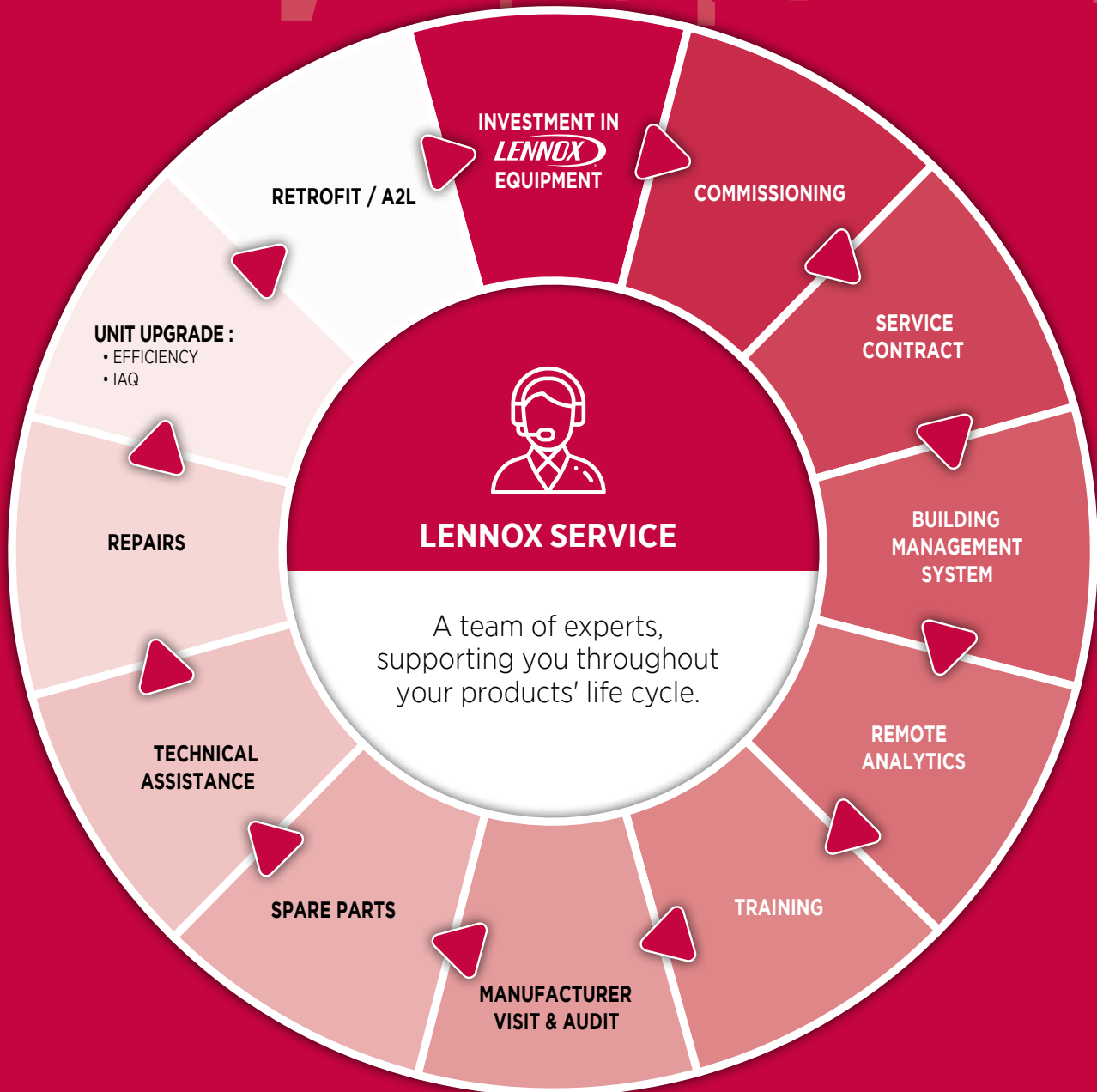































at your service!



WHO ARE WE?	3
A WORLD OF APPLICATIONS	4
REGULATIONS AND CERTIFICATIONS	6

AIR CONDITIONING & HEATING		Refrigerants	Cooling/Heating capacity & Airflow rate	Page
Rooftops	Evio	 R32	❄️ 29 - 250 kW / 💧 29 - 247 kW 🌀 4000 - 49500 m³/h	 19
	e-Baltic	 R32	❄️ 31 - 207 kW / 💧 30 - 207 kW 🌀 5700 - 35000 m³/h	 27
	Baltic	 R410A	❄️ 22 - 122 kW / 💧 21 - 115 kW 🌀 4200 - 23500 m³/h	 33
	Baltic	 R410A	❄️ 47 - 90 kW / 💧 60 - 117 kW 🌀 7100 - 14500 m³/h	--- 33
	Flexair	 R410A	❄️ 85 - 217 kW / 💧 79 - 222 kW 🌀 15000 - 39000 m³/h	 39
	Flexair	 R410A	❄️ 85 - 170 kW / 💧 112 - 127 kW 🌀 15000 - 30000 m³/h	--- 39
Chillers & Heat Pumps	eComfort MC 	 R32	❄️ 220 - 700 kW / 💧 220 - 450 kW	 53
	eComfort 	 R32	❄️ 35 - 210 kW / 💧 35 - 210 kW	 63
	eProcess 	 R1234ze R515B	❄️ 310 - 1550 kW	 79
		 R513A	❄️ 330 - 1950 kW	 79
		 R1234ze	❄️ 280 - 1220 kW	 79
		 R513A	❄️ 200 - 1450 kW	 79
Roomtops	Flatair 	 R410A	❄️ 22 - 33 kW / 💧 20 - 29 kW 🌀 3700 - 5600 m³/h	--- 125
	Flatair Essential	 R410A	❄️ 22 - 27 kW / 💧 12,5 - 27,9 kW 🌀 2040 - 5060 m³/h	--- 130
	Compactair 	 R410A	❄️ 22 - 82 kW / 💧 20 - 80 kW 🌀 5400 - 18700 m³/h	--- 133
	Compactair Essential	 R410A	❄️ 19 - 97 kW / 💧 20 - 105 kW	--- 141
	Aqualean	 R410A	❄️ 2,79 - 41 kW / 💧 3,37 - 50 kW 🌀 670 - 7500 m³/h	--- 143
Condensing Units	ASC/ASH	 R410A	❄️ 19,7 - 228 kW / 💧 19,8 - 218 kW	--- 155
VRF	e-Lite	 R410A	❄️ 8 - 270 kW / 🏠 3 - 96 HP	--- 163

AIR TREATMENT & VENTILATION		Refrigerants	Cooling/Heating capacity & Airflow rate	Page	
Fan Coil Units	Allegra II	  WATER	❄️ 0.5 - 8.9 kW / 🔥 0.7 - 11.6 kW 🌀 60 - 1670 m³/h	 175	
	Armonia II	  WATER	❄️ 1.5 - 10.8 kW / 🔥 1.9 - 13.5 kW 🌀 225 - 1536 m³/h	 179	
	Comfair II HD	  WATER	❄️ 1.5 - 3.9 kW / 🔥 1.8 - 4.9 kW 🌀 234 - 620 m³/h	 185	
	Inalto	  WATER	❄️ 3 - 28 kW / 🔥 3,7 - 37,7 kW 🌀 516 - 5668 m³/h	 189	
	Comfair HH/HV	  WATER	❄️ 2,8 - 50,6 kW / 🔥 4,9 - 60 kW 🌀 840 - 8000 m³/h	 193	
Units Heaters	Axil/Equitherm	  WATER	❄️ 4 - 20 kW / 🔥 12 - 105 kW 🌀 1600 - 9100 m³/h	--- 199	
	Axil EC	  WATER	❄️ 4 - 22 kW / 🔥 3 - 44kW 🌀 740 - 7085 m³/h	--- 203	
Air Handling Units	CleanAir LX	  ---	❄️ 2 - 550 kW / 🔥 10 - 1300 kW 🌀 1000 - 100000 m³/h	 209	
Air-Cooled Condensers & Dry-coolers	Neostar	---  HFC	📊 18 - 1280 kW	--- 213	
	FC/FI Neostar	---  WATER	📊 20 - 1200 kW	--- 213	
	V-King	---  WATER	📊 50 - 2200 kW	--- 213	
CONTROL & SUPERVISION				Page	
Control and supervision	LennoxCloud	---	---	---	217
	e-savvy	---	---	---	219

WHO ARE WE?

LENNOX EMEA (Europe, Middle-East, Africa) is a leading provider of refrigeration, heating, air conditioning and air handling solutions. We are committed to assisting our clients in their projects in order to provide optimal and sustainable solutions.

At LENNOX EMEA, we ensure that every employee develops within the group and contributes to our customers' projects success. Our reputation grows every day by providing maximum comfort and efficiency through our air conditioning and refrigeration solutions.

Our reputation as a leading market player is based on simple principles that guide our actions: the ability to listen to our customers, knowledge of their business and understanding of their needs.

The commitment and expertise of all **LENNOX EMEA** employees are key to the trust our customers place in us every day and to ensuring the continuity of our relationships.

More than ever, **LENNOX EMEA** is committed to rising to tomorrow's challenges alongside you.

Thierry JOMARD

VP, Managing Director LENNOX EMEA



OUR KEY FIGURES



900 employees
in Europe

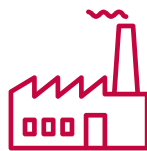

3 European production sites:
Genas, Longvic and Burgos



Quality certification:
ISO 9001 - 14001 - OHSAS 18001



1 European
training centre



1 European HVAC&R
development centre



9 subsidiaries and
sales offices



Commercial presence over
46 countries

A world of applications



CAFÉS RESTAURANTS

In a dining setting, guest comfort is critical to an enjoyable experience. But hard-working staff need to be taken care of as well. Lennox solutions provide reliable, efficient cooling and heating configurations that help create the perfect environment for food preparation and dining.



CONVENIENCE STORES

In smaller format stores, customer comfort and efficiency are key priorities. Lennox compact and aesthetic solutions provide the ideal temperature while optimising the energy footprint.



CULTURAL AND SPORT CENTRES

Performance and sports venues can be a challenging space to maintain temperature and humidity. Lennox solutions are designed to be easily modified for variable heating and cooling needs to accommodate any size crowd effectively and efficiently.



DATA CENTRES

In data centres, heat management is crucial. Lennox units provide reliably efficient cooling solutions that help data centre operators reduce the energy costs while maximising uptime.



FOOD RETAIL

In large, open spaces, priorities for HVAC performance include both comfort and efficiency. With Lennox one doesn't have to come at the cost of the other, with products and technology that deliver ideal heating and cooling solutions tailor-made for spacious retail settings.





HOSPITALS

For patients and guests, a healthcare environment can be an unfamiliar and uncomfortable place. Lennox products feature customizable applications with medical-grade air quality components to help enhance patient comfort and maintain a sanitary setting for everyone.



HOTELS

The environment in a hospitality setting is closely associated with customer satisfaction. Lennox can optimise guest comfort with a range of heating and cooling solutions while providing property owners with the most efficient options to maximize their HVAC investment in every location.



INDUSTRY

In large, open industrial spaces, keeping the set temperature constant across the entire building is of utmost importance. Lennox solutions offer industrial spaces accurate temperature, regardless of the activity or time.



NON-FOOD RETAIL

In large, open spaces, priorities for HVAC performance include both comfort and efficiency. With Lennox one doesn't have to come at the cost of the other, with products and technology that deliver ideal heating and cooling solutions tailor-made for spacious retail settings.



OFFICE BUILDINGS

A facility with an optimal HVAC system can have a direct impact on employee performance. Offering system-wide temperature control, as well as individual office control, Lennox can help enhance employee focus in a comfortable working environment.



SHOPPING MALLS

A pleasant store environment means longer visit times and potentially increased sales. Lennox customized products and controls offer retail spaces the most effective heating and cooling options, regardless of their size or configuration.



STORAGE & LOGISTICS

A key success metric in distribution applications is keeping employees productive when fulfilling orders. Lennox products and technology have been engineered to maintain comfort without compromising efficiency to deliver a win/win for staff and facility owners.



The LII group has a 125-year history inventing new technologies, developing new products and continuously enhancing product quality and improvements that address the world's heating, cooling and air quality challenges.

Following the group's lead, we at Lennox EMEA, are ready and committed to tackling climate change by designing, manufacturing and marketing efficient and environmentally-friendlier HVAC-R solutions. Developing products with progressively less carbon impact – through greater energy efficiency and use of refrigerants with lower global warming potential (GWP) is at the heart of our product strategy.

For the last few years, we have been dedicated to aligning the design of our climate control and refrigeration solutions with the European EcoDesign and F-Gas regulations.

Our Lennox HVAC units have recently been upgraded to meet or exceed the new EcoDesign 2021 thresholds, while we are continuing our refrigerant transition towards R32 and lower GWP refrigerants.

OVERVIEW OF OUR SUSTAINABLE JOURNEY

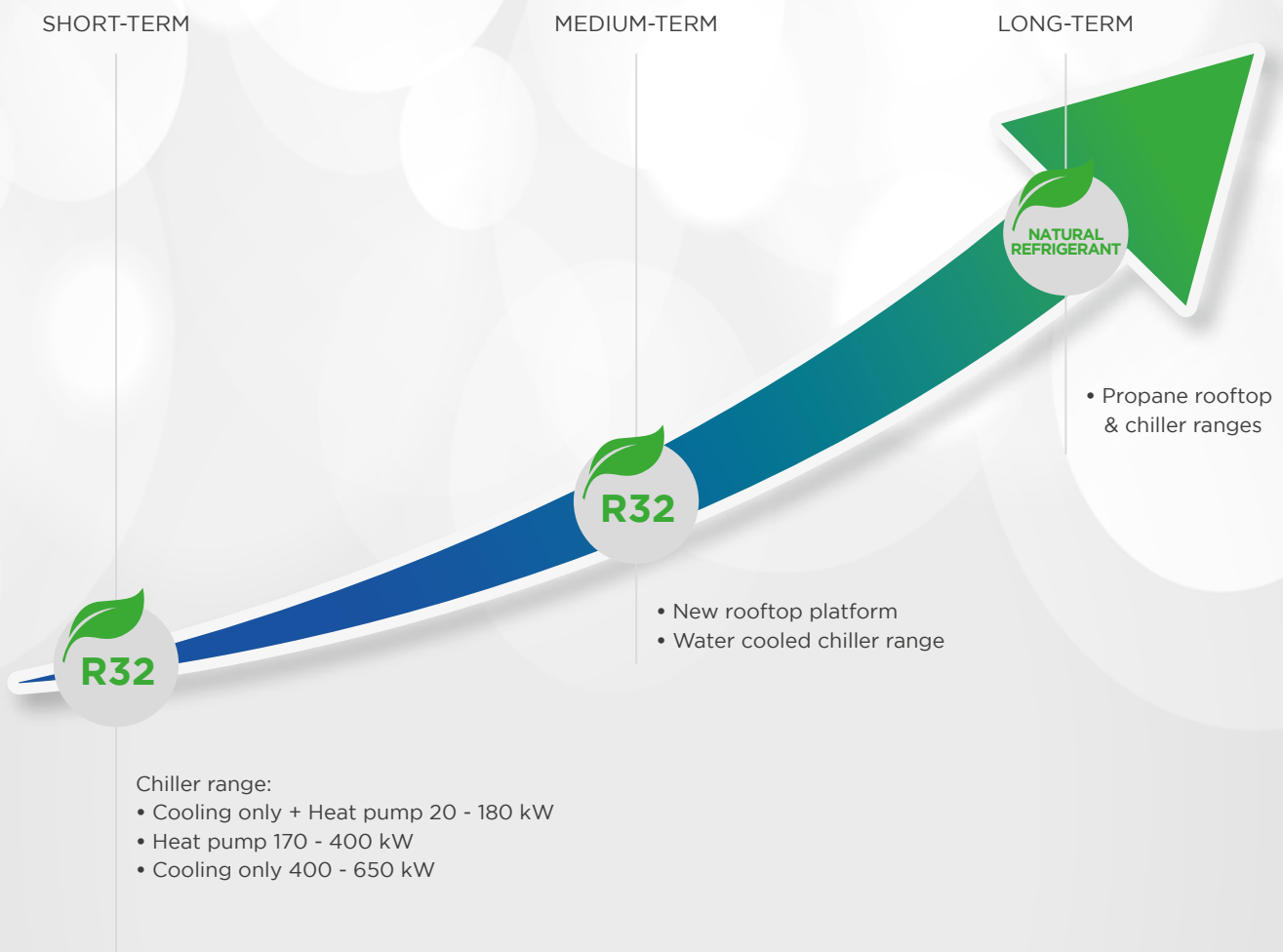

ECODESIGN

Directive 2009/125/EC

The **KYOTO** Agreement (1997), the **COP 21** (Paris 2015) and the **COP 22** (Marrakech 2016) set targets for limiting global warming to 1.5 °C. The **Ecodesign Directive 2009/125/EC** defines a framework for all energy-consuming equipment. Voted on in 2007, and implemented since 2008, it aims to reduce the power consumption of electronic devices through better design (ecodesign).

The implementation of the Ecodesign Directive is split into several areas of related products, called **"lots"**, focusing on the product areas with the most substantial energy consumption and the highest potential for energy savings.

The Ecodesign Directive is mandatory for all products marketed and used in the European Union (CE marking).



MINIMUM EFFICIENCY PERFORMANCE STANDARD (MEPS)

Requirements for minimum efficiency performance are set in Europe as a consequence of the implementation of the Ecodesign Directive. The regulation has been introduced step-by-step and the requirements gradually intensified over time.

With the introduction of the second and last tier of ENER LOT 21, or directive (EU) 2016/2281 for air heating and cooling products, high temperature process chillers and fan coil units, most of our units have had their minimum energy performance levels increased, and have thus been optimised to meet or exceed the new thresholds.

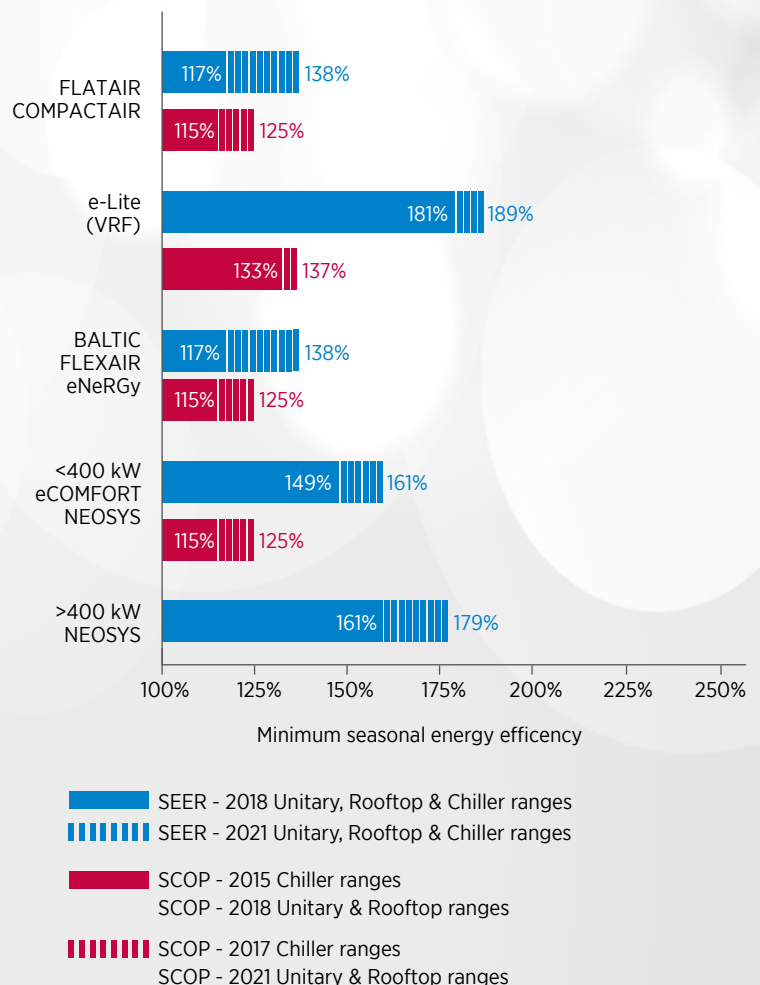

The Aqualean, Baltic water cooled, Flexair water cooled ranges are impacted, but no minimum performance to be reached. The eNeRGy without condenser range is impacted by the EU 2014/1253 (ventilation units). The ASC / ASH condensing units are not impacted.

WHAT IS F-GAS?

The chlorofluorocarbon (CF) and hydrofluorocarbon (HCFC) refrigerants used in cooling systems today are considered to be powerful greenhouse gases. To prevent climate changes and global warming, the European Commission has adopted a roadmap to reduce global emissions by 2050.

EU Regulation No. 517/2014, known as **F-Gas**:

- # Lays down rules regarding the containment, use, recovery and destruction of fluorinated greenhouse gases and the related measures.
- # Lays down the conditions for marketing certain products and equipment containing HFCs.
- # Imposes conditions on certain specific uses of fluorinated greenhouse gases.
- # Sets quantitative limits (quotas) for marketing HFCs.

This Regulation is for all companies that install, maintain and sell equipment containing refrigerants, as well as those that handle and distribute them.

DESIGN & MAINTENANCE OF EQUIPMENT

All equipment must be designed to prevent accidental discharge of greenhouse gases. Technical measures are taken upstream in order to minimise these leaks (refer to Regulation (EU) No. 517/2014 specifying the procedures for leakage checks).

The F-Gas regulation on fluorinated gases imposes:

- # Frequent inspections.
- # Qualification of companies & their agents.

QUOTAS: "PHASE DOWN"

The European Commission is responsible for assigning the HFC quotas available on the market to companies. This measure aims to reduce the total amount of HFCs available on the market, so that the remaining share of HFCs (21% in 2030) is only used for the maintenance of existing equipment and/or for certain specific applications for which there is no alternative.

Marketing timetable (expressed in t CO₂e)

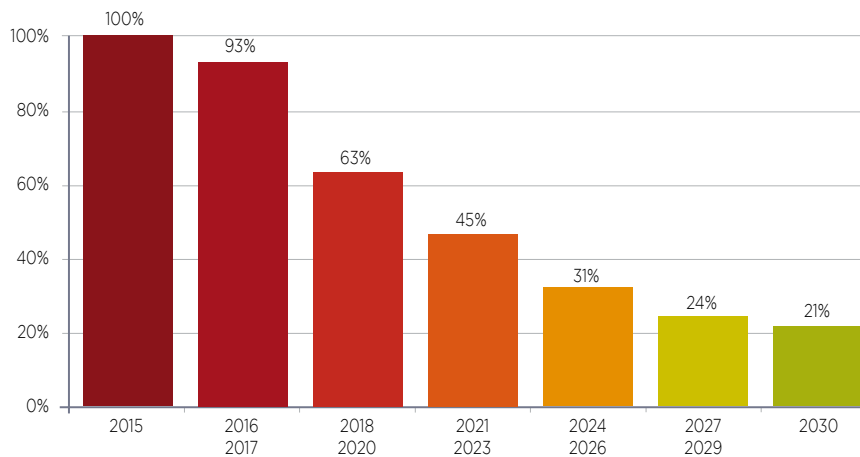

WHAT IS GWP?

All HFC refrigerants placed on the market are classified according to a Global Warming Potential (GWP). The GWP is an index that characterises the action of a chemical compound on the greenhouse effect within a given time. The reference refrigerant is CO₂, of which the GWP is 1. The lower the index, the more environmentally-friendly the refrigerant.

New equipment is subject to restrictions based on the GWP of the refrigerants. So, refrigerants with a GWP greater than 2500 have been banned in new installations since January 2020.





The availability of HFCs will be limited by falling production quotas.

Refrigerants overview according to their GWP

Refrigerants	R404A	R410A	R134a	R452B	R32	R513A	R454B	R1234ze	R290 (Propane)
GWP	3922	2088	1430	698	675	631	466	6	3

R32, THE OBVIOUS ALTERNATIVE TO R410A

In the quest of alternative solutions to this HFC quota reduction, R32 is an obvious choice to replace R410A. It already makes up 50% of its composition, and it has a number of other key advantages:

-  Low cost
-  Pure substance
-  Many providers due to no patent
-  Already available on residential market
-  GWP = 675

R513A & R1234ze, OPTIMUM REPLACEMENTS FOR R134a

R513A and R1234ze are excellent alternatives to R134a. These high-density refrigerants are ideal for large capacity chillers, with screw compressors. Both refrigerants are easy to retrofit to R134a systems – and because they are much less damaging to the environment, they benefit from lower taxes and leak test demands.

ISO

A guarantee of quality

The ISO family of standards has been developed to address various aspects of quality management. ISO certification enables us to guarantee the circulation of safe and quality products on the market. The various ISO standards also contribute to the fact that companies such as ours optimise their production methods, while guaranteeing our employees' safety.

Our company is ISO-certified and thus meets quality assurance criteria:

ISO 9001 - lays down the criteria applicable to a quality management system.

ISO 14001 - lays down the criteria applicable to an environmental management system.

OHSAS 18001 - establishes the method for setting up an occupational health and safety management system.



CE

The **CE marking** was created within the framework of European technical harmonisation legislation. It represents a manufacturer's commitment that its product complies with the regulatory requirements for free movement throughout the European Union. This marking is mandatory for all products covered by one or more European regulatory texts that explicitly provide for it. As a manufacturer, and in order to allow the circulation of our products, we rigorously ensure the conformity of our products with regard to the essential requirements defined by European legislation.

Our declaration of conformity specifies the applicable guidelines for the entire catalogue by product range.



At Lennox, we know that purchasing equipment is just the beginning of your HVAC investment. That's why we are committed to offer you unique support over the entire life of your equipment.

From commissioning to modernisation of your HVAC system, our service team is here to provide you with the right expertise in order to ensure its optimal running and extended lifespan.



LENNOX CARE

Benefit from OEM expertise for peace of mind.

Commissioning: our technicians perform all startup procedures and ensure your system is running efficiently and reliably from the start.

Maintenance: HVAC units often operate under harsh conditions that can affect their lifetime and performance, leading to extra energy consumption and operational costs. Partnering with our experts is the guarantee maintenance checks and audits are performed at the right time.

Repairs: count on our factory-trained technicians to efficiently solve problems and reduce downtime.

SPARE PARTS

Order them quickly and easily.

For your own repairs, our dedicated team supports you throughout the process of spare parts procurement – from the selection to the delivery.

MODERNISATION

Take your HVAC equipment to the next level.

Rely on our team to make sure your existing equipment keeps running efficiently. Our upgrade solutions – from latest fan technology, Indoor Air Quality (IAQ), controls & connectivity, to lower GWP refrigerants – will help you to keep a high performing building.



LENNOX EMEA UNIVERSITY

Training is one of the most important investments you can make in your business, and your future. The best technicians, sales and business people are life-long learners. The technician who's up to speed on the latest industry technology earns a customer's loyalty. A salesperson who sells an extra unit per week can bring in a significant extra in annual profit. Business owners and office staff who take the time to enhance their own knowledge and skills will create a thriving, growing workplace.

Lennox EMEA University offers training programmes, designed to help you hone your skills, expand your knowledge in an ever changing technological and regulatory environment and excel in your field. With our face-to-face, virtual classroom or webinar offerings, you can choose what best works for you.

All our trainings are delivered by our experienced instructors who have extensive knowledge in the HVAC-R industry and Lennox equipment.

ON-SITE COURSES

- Learn how to install and service Lennox units.
- Learn how to handle A2L refrigerants.
- Sessions offered at various locations.

VIRTUAL COURSES

- Training, with no travel. We're bringing the classroom to you.
- Keep up with the latest industry trends and regulations.



ROOFTOP UNITS



Evio

19



e-Baltic

27



Baltic

33



Flexair

39



WHAT IS A ROOFTOP ?

A rooftop, as the name suggests, is an HVAC unit located on the roof of a building. A rooftop can be installed on many different types of buildings, such as warehouses, shopping malls, industrial workshops, supermarkets, restaurants. The aim of a rooftop is to provide heated and cooled air to a defined area. The air is distributed through ductwork that define its route.

A rooftop is a compact air handler that is installed externally, and, therefore, designed and constructed to face all the elements. Unlike other HVAC units, a rooftop is self-contained and thus not connected to any other decentralized component. Rooftops represent an easy and simple way of providing air-conditioning: an all-in-one unit with plug and play installation.

Our range of rooftops offers flexibility in terms of design and sizing to be able to answer multiple applications, whether you are looking to equip an existing installation or a new one.

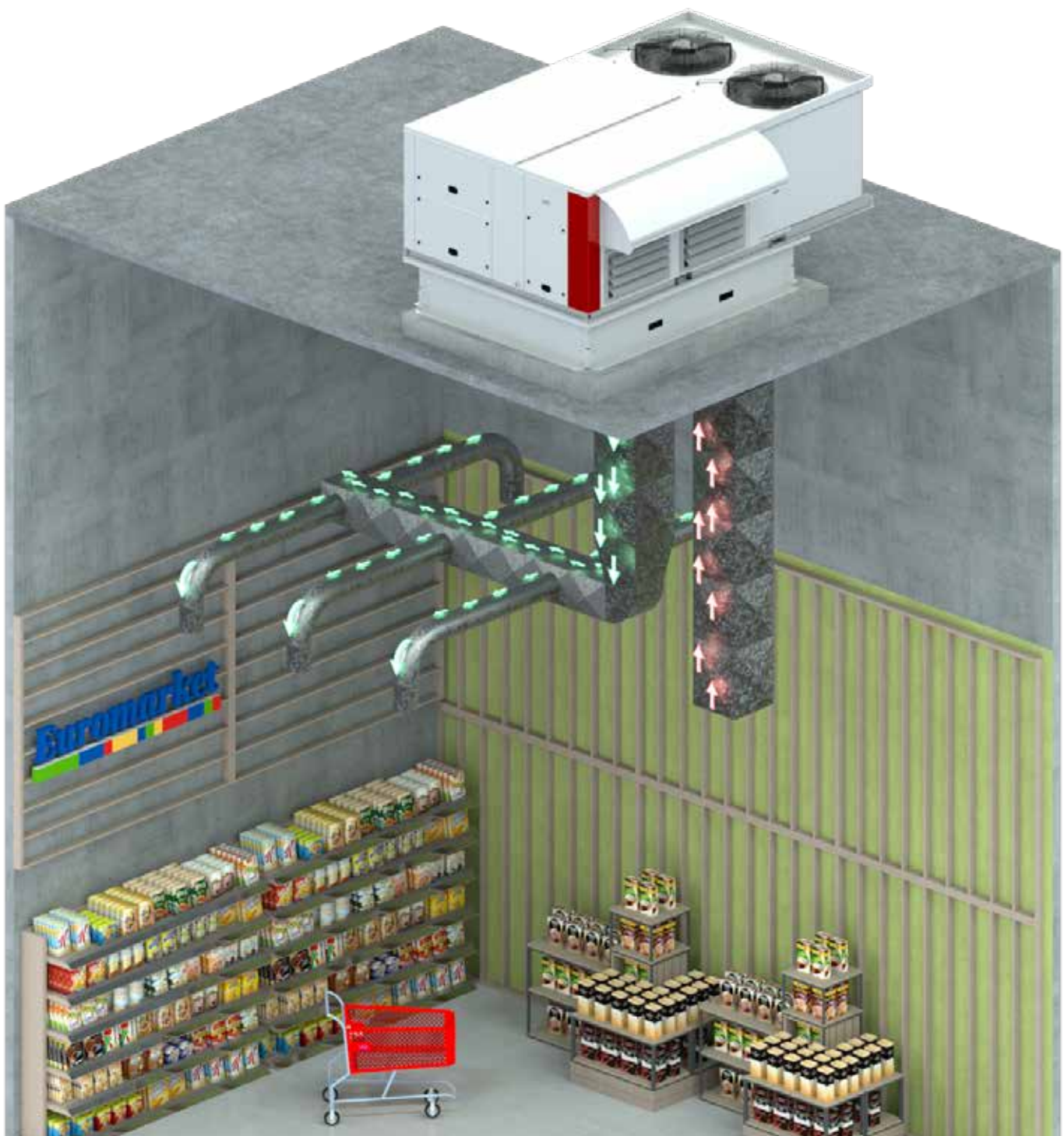

ROOFTOP UNITS

AIR COOLED / WATER COOLED

	Evio			* 29 - 250 kW * 29 - 247 kW ~ 4000 - 49500 m ³ /h		
	e-Baltic			* 31 - 207 kW * 30 - 207 kW ~ 5700 - 35000 m ³ /h		
	Baltic			* 22 - 122 kW * 21 - 115 kW ~ 4200 - 23500 m ³ /h		
	Flexair			* 85 - 217 kW * 79 - 222 kW ~ 15000 - 39000 m ³ /h		
	Baltic			* 47 - 90 kW * 60 - 117 kW ~ 7100 - 14500 m ³ /h		-
	Flexair			* 85 - 170 kW * 112 - 127 kW ~ 15000 - 30000 m ³ /h		-

Air/Air

* Cooling capacity

Cafés Restaurants

Shopping malls

Water/Air

~ Heating capacity

Non food retail

Storage & Logistics

~ Airflow rate

Food retail

Industry

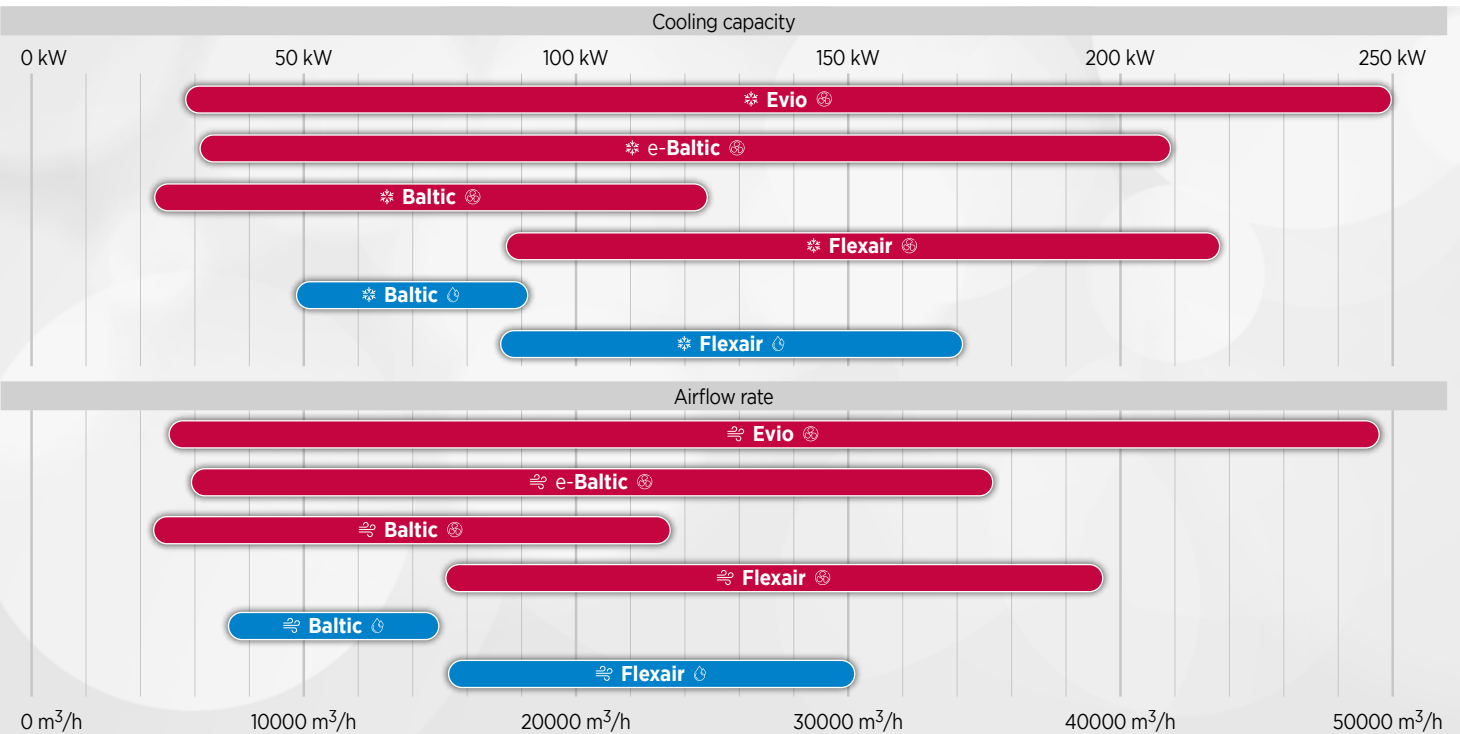

ROOFTOP UNITS | Available equipment

■ Standard equipment ● Option

Additional configurations/options are available on request, please contact your sales representative.

		Evio EV	e-Baltic eBBH	e-Baltic eBFH	BALTIC BAC/BAH	FLEXAIR FAC/FAH
CASING	Pre-coated galvanised steel (white)	■	■	-	■	-
	Pre-coated aluminium (white)	-	-	■	-	■
INSULATION	M0 fire-proof classification	-	■	■	■	■
	M1 fire-proof classification	■	-	-	-	-
	25 mm double-skin	-	■	■	■	■
	50 mm double-skin	■	●	●	●	●
CONDENSATE DRAIN PAN	Removable drain pan	■	■	■	■	■
	Aluminium drain pan	■	■	■	■	■
AIR FLOW CONFIGURATION	Downflow supply	■	■	■	■	■
	Horizontal supply	●	●	●	●	●
	Upflow supply	●	-	●	-	●
	Downflow return	■	■	■	■	■
	Horizontal return	●	●	●	●	●
	Upflow return	●	●	●	●	●
	100% fresh air	●	●	●	●	●
AIR FILTER	G3	-	■	■	■	■
	G4	■	●	●	●	●
	Refillable G4	●	●	●	●	●
	M5 (ePM10 50%)	●	●	●	●	●
	F7 (ePM1 50%)	●	●	●	●	●
	F9 (ePM1 85%)	●	●	●	●	●
AUXILIARY HEATING	Modulating gas burner	●	●	●	●	●
	Natural gas burner	●	●	●	●	●
	Propane gas burner	●	●	●	●	●
	Electric heater (2-step or modulating 0-100%)	●	●	●	●	●
	Electric pre-heater (modulating 0-100%)	●	●	●	●	●
	Hot water coil	●	●	●	●	●
ANTI-CORROSION PROTECTION	LenGuard anti-corrosion protection on evaporator coil	●	●	●	●	●
	LenGuard anti-corrosion protection on condenser coil	●	●	-	-	-
	"Urban" anti-corrosion protection : C4 (Fins)	●	-	-	-	-
ENERGY RECOVERY	Cross flow plate heat exchanger	●	●	-	●	-
	Rotary wheel heat exchanger	●	●	●	●	●
	Thermodynamic heat recovery	●	●	-	●	-
	eRecovery on food refrigeration systems	●	●	●	●	●
SUPPLY FAN	Direct drive & variable speed centrifugal EC plug fan (low & high pressure)	■	■	■	■	■
CONDENSER	Air cooled : Variable speed & low noise axial EC fan	■	■	■	■	■
	Water cooled : Plate exchanger	-	-	-	■	■
ECONOMISER	Motorised free-cooling/heating	■	■	■	■	■
EXHAUST	Gravity exhaust damper	●	●	●	●	●
	Power exhaust axial fan & gravity damper	●	●	●	●	●
	Centrifugal EC exhaust plug fan (direct drive and variable speed) & gravity damper	●	●	●	●	●
ROOF CURB	Non adjustable non assembled roof curb	-	●	●	●	●
	Adjustable roof curb	●	●	●	●	●
	Multidirectional airflow roof curb	-	●	●	●	●
PACKING	Container packing	-	●	●	●	●

■ Standard equipment ● Option

Additional configurations/options are available on request, please contact your sales representative.

Evio
Ev

e-Baltic
eBBH

e-Baltic
eBFH

BALTIC
BAC/BAH

FLEXAIR
FAC/FAH

REFRIGERANT	R32	■	■	■	-	-
	R410A	-	-	-	■	■
	Refrigerant leak detection	■	■	■	●	●
COMPRESSOR	Inverter	-	-	-	-	-
	Multiscroll	■	■	■	■	■
	Tandem	■	■	■	■	■
	Silent start	●	●	●	●	●
	Compressor noise jacket	●	●	●	●	●
EXPANSION VALVE	Electronic (bi-flow for heat pump)	■	■	■	■	■
CONTROL	eClimatic (programmable controller)	■	■	■	■	■
	Regulation on supply or ambient temperature	■	■	■	■	■
	7 time zones per day with 4 different operating modes	■	■	■	■	■
	Dirty filter alarm	■	■	■	■	■
	Dynamic defrost	■	■	■	■	■
	Alternate defrost	■	■	■	■	■
	Morning anticipation	■	■	■	■	■
	Dynamic setpoint	■	■	■	■	■
	Variable airflow management of supply fan	■	■	■	■	■
	eFlow airflow rate on display	■	■	■	■	■
	Variable airflow management of condenser fan	■	■	■	■	■
	Economiser power stage & free-cooling/heating	■	■	■	■	■
	Energy recovery module power stage (if energy recovery option)	■	■	■	■	■
	Compressors capacity steps (up to 4)	■	■	■	■	■
	Auxiliary heating capacity steps	■	■	■	■	■
Intelligent fresh air management (Patent 03 50616)	■	■	■	■	■	
COMMUNICATION	Master/Slave operation up to 24 units	●	●	●	●	●
	Smart building management system : e-savvy (up to 16 units)	●	●	●	●	●
	Distance Management System : LennoxCloud connectivity	●	●	●	●	●
	Distance Management System : LennoxOneWeb, ...	-	●	●	●	●
	External dry & analogic contacts board	●	●	●	●	●
	ModBus RS485 interface	●	●	●	●	●
	BACnet RS485 interface	●	●	●	●	●
	ModBus & BACnet TCP/IP interface	●	●	●	●	●
DISPLAY INTERFACE	DC (comfort display)	●	●	●	●	●
	DM (multi-units display)	●	●	●	●	●
	DS (service display)	●	●	●	●	●
	Touchscreen (display 7")	●	-	-	-	-
CONTROL AND SAFETY DEVICES	Main disconnect switch	■	■	■	■	■
	Smoke detector	●	●	●	●	●
	Fire thermostat	●	●	●	●	●
	Soft starter/Air sock control	●	●	●	●	●
	CO ₂ control	●	●	●	●	●
	Humidity control	●	●	●	●	●
	Multi-ambient temperature	●	●	●	●	●
	Variable airflow management/constant pressure	●	●	●	●	●
	Energy meter	●	●	●	●	●

Evio

Air cooled rooftop units





R32



AIR COOLED

 29 - 250 kW

 29 - 247 kW

 4000 - 49500 m³/h

LENNOX participates in the ECP
programme for RT.
Check ongoing validity of certificate :
www.eurovent-certification.com

- # **Flexibility** in capacity and airflow rates, ventilation options, energy sources and design (configurations and roof curbs) to best fit your application's needs.
- # **Optimized design** and integration of highly efficient components, allowing significant energy savings.
- # **Low noise level** thanks to several sound attenuation options available.
- # **Installation and replacement** made easy thanks to the unit's compactness, same footprint and weight than previous models.

AIR TREATMENT

- # EC motor fans ensure a precise temperature for better comfort and energy savings.
- # IAQ kits for improved indoor air quality within the building:
 - Media filters (M5/ePM10 50%, F7/ePM1 50%, F9/ePM1 85%).



AIRFLOW

- # Several available airflow configurations: top, bottom or horizontal, to fit each building's need.
- # Adaptable roof curb to fit the building's architecture.
- # Frame adaptation for replacement market.

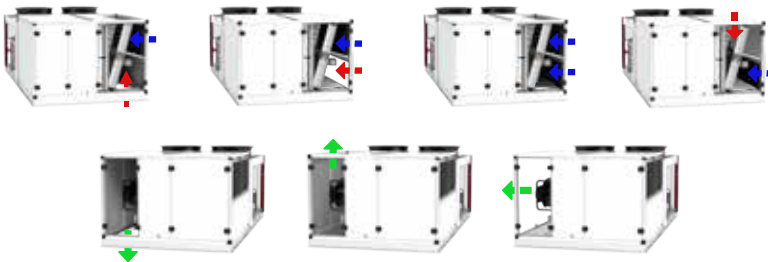

AUXILIARY HEATING DEVICES

- # Different options depending on the energy source available on site:
 - Hot water coil.
 - Electric heater.



HEAT RECOVERY

- # Water coil recovery, to recover free heat or free cool produced by external water systems climates.
- # Plate heat exchanger, to improve the system's efficiency in colder climates by preheating the fresh air stream.
- # Heat recovery wheel, with both fresh and return air sections protected by G4 filters.

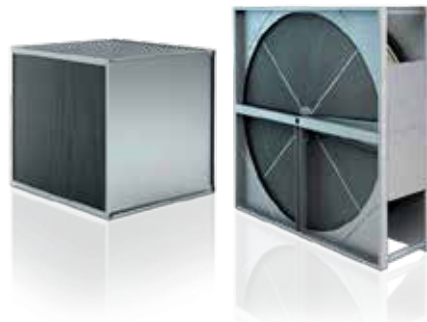

CASING & DESIGN

- # New design.
- # Pre-coated steel panels painted in RAL 9003 color, specially designed for corrosion resistance and to ensure long operation lifetime.
- # Compact design for perfect integration in its environment.
- # Same footprint as previous models for plug & play replacement.
- # Inclined removable drain pan in aluminum for easy disinfecting.
- # Double skin panels.

THERMODYNAMIC SYSTEM

- # R32 refrigerant (GWP = 675) enabling a decrease of the carbon dioxide equivalent for potential tax savings.
- # Tandem scroll compressors allowing capacity modulation.
- # Variable refrigerant control with electronic expansion valve.
- # Heat transfer efficiency thanks to new coil design.
- # Easy access to compressors enabling faster maintenance operations.
- # Fan with variable speed EC motor and swept blades, enabling control of the high and low floating pressure for optimum operation.
- # Integrated safety devices for peace of mind.

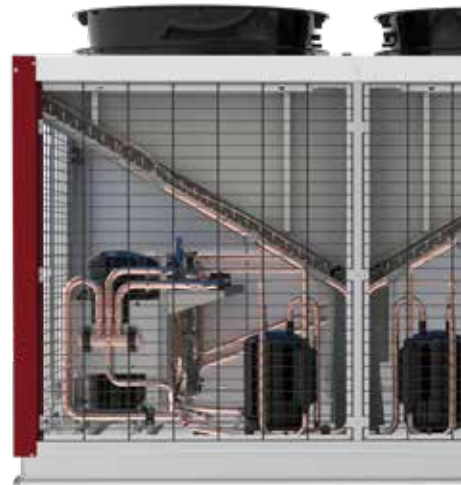

CONTROL

- # eClimatic electronic controller and intelligent control parameters optimising part-load efficiency.
- # Integrated communication solutions offering flexibility (master/slave, Modbus, BACnet).
- # Several display solutions for different access levels.

REMOTE MONITORING

- # Connectivity through **LennoxCloud** (LENNOX WEB PORTAL for Multi sites / Multi units).
- # BMS through: **e-savvy**

eCLIMATIC



DS Service display



Touchscreen display



DC Comfort display



Ev_(A) 125_(B) A_(C) H_(D) 055_(E) S_(F) P_(G) F_(H) 1_(I)

- (A) **Ev** = Evio
- (B) **B** = Maximum air flow (x 100 m³/h)
- (C) **A** = Air cooled
- (D) **H** = Heat pump
- (E) **055** = Commercial cooling capacity in kW
- (F) **S** = 1 circuit - **D** = 2 circuits
- (G) **P** = R32
- (H) **F** = Scroll
- (I) **1** = Revision



Air cooled version

Heat pump units

Evio	100AH			125AH	185AH				
	25	35	45	55	55	60	65	70	
Nominal thermal performances - Cooling mode									
Cooling capacity ⁽¹⁾	kW	28,7	38,5	45,1	52,7	53,4	58,9	67,2	68,8
Total Power Input	kW	9,3	13,0	15,8	16,8	15,9	20,4	21,6	24,4
EER net ⁽¹⁾		3,08	2,96	2,85	3,14	3,36	2,88	3,11	2,82
Nominal thermal performances - Heating mode									
Heating capacity ⁽²⁾	kW	29,1	40,9	47,2	53,4	53,3	56,3	66,3	63,2
Total Power Input	kW	7,6	9,7	12,8	14,5	13,0	15,2	19,0	18,0
COP net ⁽²⁾		3,85	4,21	3,70	3,68	4,10	3,70	3,48	3,51
Seasonal efficiencies - Cooling mode									
Seasonal Energy Efficiency Ratio - SEER ⁽³⁾		4,68	4,78	4,65	4,63	4,98	4,93	4,78	4,88
Seasonal energy efficiency - η_{s,c} ⁽⁴⁾	%	184	188	183	182	196	194	188	192
Eurovent energy efficiency class - Part load operation		B	A	B	B	A	A	A	A
Seasonal efficiencies - Heating mode									
Seasonal Coefficient of Performance - SCOP ⁽⁵⁾		3,73	4,03	4,05	3,58	3,75	3,90	3,43	3,88
Seasonal energy efficiency - η_{s,h} ⁽⁶⁾	%	146	158	159	140	147	153	134	152
Eurovent energy efficiency class - Part load operation		A	A+	A+	B	A	A+	B	A+
Ventilation data									
Minimum airflow rate	m ³ /h	4000	5500	6500	7500	7500	9000	9500	10500
Nominal airflow rate		5000	7000	8000	9500	9500	11000	12000	13000
Maximum airflow rate		10000	10000	10000	12500	18500	18500	18500	18500
Boosted airflow rate		13500	13500	13500	13500	22000	22000	22000	22000
Acoustic data - Standard unit									
Outdoor sound power	dB(A)	73	73	83	78	77	84	83	86
Indoor blower outlet sound power		69	78	82	87	71	75	77	79
Electrical data									
Maximum power	kW	11,2	13,2	23,4	21,2	23,6	47,3	30,4	37
Maximum current	A	79,7	81,1	116,4	114,1	118	177,4	162,7	216,4
Starting current	A	20,2	23	38,5	36,7	40,6	52,5	51,4	59,8
Short circuit current	kA	10	10	10	10	10	10	10	10
Refrigeration circuit									
Number of circuits		1	1	1	2	2	1	2	1
Number of compressors		2	2	2	3	3	2	3	2
Refrigerant load	kg	6,5	10	9,9	6,6/6,6	6,6/6,6	9,6	6,1/6,1	9,3
Unit weight									
Standard air cooled unit	kg	677	705	735	910	1024	890	1068	893

(1) **Cooling mode** : According to EN14511 nominal conditions - Outdoor temperature 35°C DB - Indoor temperature 27°C DB / 19°C WB

(2) **Heating mode** : According to EN14511 nominal conditions - Outdoor temperature 7°C DB / 6°C WB - Indoor temperature 20°C DB

(3) SEER in accordance with standard EN14825.

(4) Space cooling energy efficiency following Ecodesign regulation EU 2016/2281

(5) SCOP in accordance with standard EN 14825 (average climate conditions).

(6) Space heating energy efficiency following Ecodesign regulation EU 2016/2281.

Ev^(A) 125^(B) A^(C) H^(D) 055^(E) S^(F) P^(G) F^(H) 1^(I)

- (A) **Ev** = Evio
 (B) **B** = Maximum air flow (x 100 m³/h)
 (C) **A** = Air cooled
 (D) **H** = Heat pump
 (E) **055** = Commercial cooling capacity in kW
 (F) **S** = 1 circuit - **D** = 2 circuits
 (G) **P** = R32
 (H) **F** = Scroll
 (I) **1** = Revision



Air cooled version

Heat pump units

Evio		185AH			270AH					
		75	85	95	85	95	105	115	130	145
Nominal thermal performances - Cooling mode										
Cooling capacity ⁽¹⁾	kW	75,0	84,3	91,5	90,1	94,5	104,5	114,0	122,7	135,3
Total Power Input	kW	25,5	29,4	32,3	28,3	30,9	34,3	39,0	44,8	49,7
EER net ⁽¹⁾		2,94	2,86	2,83	3,19	3,06	3,05	2,92	2,74	2,72
Nominal thermal performances - Heating mode										
Heating capacity ⁽²⁾	kW	76,3	86,5	93,6	86,4	93,1	103,3	108,1	113,7	133,1
Total Power Input	kW	21,6	25,1	28,3	23,2	25,6	28,9	32,3	36,9	41,4
COP net ⁽²⁾		3,53	3,45	3,30	3,72	3,63	3,58	3,34	3,09	3,21
Seasonal efficiencies - Cooling mode										
Seasonal Energy Efficiency Ratio - SEER ⁽³⁾		4,73	4,58	4,53	5,03	4,98	5,00	4,98	4,90	4,90
Seasonal energy efficiency - η_{s,c} ⁽⁴⁾	%	186	180	178	198	196	197	196	193	193
Eurovent energy efficiency class - Part load operation		A	B	B	A	A	A	A	A	A
Seasonal efficiencies - Heating mode										
Seasonal Coefficient of Performance - SCOP ⁽⁵⁾		3,83	3,63	3,58	3,85	3,80	3,90	3,80	3,73	3,65
Seasonal energy efficiency - η_{s,h} ⁽⁶⁾	%	150	142	140	151	149	153	149	146	143
Eurovent energy efficiency class - Part load operation		A+	A	B	A+	A+	A+	A+	A	A
Ventilation data										
Minimum airflow rate	m ³ /h	11000	13000	13500	13000	13500	14000	16000	18000	21500
Nominal airflow rate		14000	16000	17000	16000	17000	19000	21000	24000	27000
Maximum airflow rate		18500	18500	18500	27000	27000	27000	27000	27000	27000
Boosted airflow rate		22000	22000	22000	32500	32500	32500	32500	32500	32500
Acoustic data - Standard unit										
Outdoor sound power	dB(A)	85	86	87	86	87	86	86	88	89
Indoor blower outlet sound power		81	85	88	77	78	81	83	87	92
Electrical data										
Maximum power	kW	40,3	44,3	52,4	50,5	49,6	52,6	58,2	64,2	77,6
Maximum current	A	186,2	198,6	206,2	207,3	201,9	200,1	221,8	263,9	286,3
Starting current	A	66,7	74,1	86,7	82,8	82,4	88,9	97,4	107,7	130,1
Short circuit current	kA	10	10	10	10	10	10	10	10	10
Refrigeration circuit										
Number of circuits		2	2	2	2	2	2	2	2	2
Number of compressors		3	3	3	3	3	4	4	4	4
Refrigerant load	kg	10/10	9,9/9,9	9,7/9,7	10/10	9,9/9,9	10/10	9,7/9,7	9,5/9,7	13/13,1
Unit weight										
Standard air cooled unit	kg	1125	1161	1178	1260	1265	1316	1339	1365	1542

(1) **Cooling mode** : According to EN14511 nominal conditions - Outdoor temperature 35°C DB - Indoor temperature 27°C DB / 19°C WB

(2) **Heating mode** : According to EN14511 nominal conditions - Outdoor temperature 7°C DB / 6°C WB - Indoor temperature 20°C DB

(3) SEER in accordance with standard EN14825.

(4) Space cooling energy efficiency following Ecodesign regulation EU 2016/2281

(5) SCOP in accordance with standard EN 14825 (average climate conditions).

(6) Space heating energy efficiency following Ecodesign regulation EU 2016/2281.

Ev_(A) 125_(B) A_(C) H_(D) 055_(E) S_(F) P_(G) F_(H) 1_(I)

- (A) **Ev** = Evio
- (B) **B** = Maximum air flow (x 100 m³/h)
- (C) **A** = Air cooled
- (D) **H** = Heat pump
- (E) **055** = Commercial cooling capacity in kW
- (F) **S** = 1 circuit - **D** = 2 circuits
- (G) **P** = R32
- (H) **F** = Scroll
- (I) **1** = Revision



Air cooled version

Heat pump units

		360AH					
Evio		115	130	145	160	180	200
Nominal thermal performances - Cooling mode							
Cooling capacity ⁽¹⁾	kW	117,4	129,7	140,1	162,6	172,1	194,6
Total Power Input	kW	38,7	43,9	47,4	55,0	61,8	69,2
EER net ⁽¹⁾		3,03	2,95	2,96	2,96	2,79	2,81
Nominal thermal performances - Heating mode							
Heating capacity ⁽²⁾	kW	106,0	113,2	133,5	158,8	186,3	199,1
Total Power Input	kW	30,7	34,6	38,3	49,2	53,5	58,0
COP net ⁽²⁾		3,45	3,27	3,49	3,23	3,48	3,43
Seasonal efficiencies - Cooling mode							
Seasonal Energy Efficiency Ratio - SEER ⁽³⁾		5,25	5,20	5,18	5,00	4,78	5,08
Seasonal energy efficiency - η_{s,c} ⁽⁴⁾	%	207	205	204	197	188	200
Eurovent energy efficiency class - Part load operation		A+	A+	A+	A	A	A
Seasonal efficiencies - Heating mode							
Seasonal Coefficient of Performance - SCOP ⁽⁵⁾		3,93	3,88	3,80	3,63	3,98	4,20
Seasonal energy efficiency - η_{s,h} ⁽⁶⁾	%	154	152	149	142	156	165
Eurovent energy efficiency class - Part load operation		A+	A+	A+	A	A+	A+
Ventilation data							
Minimum airflow rate	m ³ /h	15000	16000	21500	24000	26500	29000
Nominal airflow rate		21000	24000	27000	30000	33000	36000
Maximum airflow rate		36000	36000	36000	36000	36000	36000
Boosted airflow rate		43500	43500	43500	43500	43500	43500
Acoustic data - Standard unit							
Outdoor sound power	dB(A)	86	88	89	91	92	92
Indoor blower outlet sound power		78	81	84	87	91	94
Electrical data							
Maximum power	kW	60,6	66,6	72,2	85,1	102	109,4
Maximum current	A	225,8	267,8	277,9	297,2	326,4	421,8
Starting current	A	101,3	111,6	121,7	141	170,2	180,6
Short circuit current	kA	10	10	10	10	10	10
Refrigeration circuit							
Number of circuits		2	2	2	2	2	2
Number of compressors		4	4	4	4	4	4
Refrigerant load	kg	9,9/9,9	9,5/9,7	13,1/13,1	12,7/12,7	20,9/20,9	20,9/20,3
Unit weight							
Standard air cooled unit	kg	1494	1516	1679	1809	1918	1970

(1) **Cooling mode** : According to EN14511 nominal conditions - Outdoor temperature 35°C DB - Indoor temperature 27°C DB / 19°C WB

(2) **Heating mode** : According to EN14511 nominal conditions - Outdoor temperature 7°C DB / 6°C WB - Indoor temperature 20°C DB

(3) SEER in accordance with standard EN14825.

(4) Space cooling energy efficiency following Ecodesign regulation EU 2016/2281

(5) SCOP in accordance with standard EN 14825 (average climate conditions).

(6) Space heating energy efficiency following Ecodesign regulation EU 2016/2281.

Ev^(A) 125^(B) A^(C) H^(D) 055^(E) S^(F) P^(G) F^(H) 1^(I)

- (A) **Ev** = Evio
 (B) **B** = Maximum air flow (x 100 m³/h)
 (C) **A** = Air cooled
 (D) **H** = Heat pump
 (E) **055** = Commercial cooling capacity in kW
 (F) **S** = 1 circuit - **D** = 2 circuits
 (G) **P** = R32
 (H) **F** = Scroll
 (I) **1** = Revision



Air cooled version

Heat pump units

Evio		415AH			
		180	200	225	250
Nominal thermal performances - Cooling mode					
Cooling capacity ⁽¹⁾	kW	180,5	195,3	222,2	247,1
Total Power Input	kW	61,5	69,3	81,9	87,3
EER net ⁽¹⁾		2,93	2,82	2,71	2,83
Nominal thermal performances - Heating mode					
Heating capacity ⁽²⁾	kW	182,5	198,6	219,6	252,2
Total Power Input	kW	50,7	57,6	67,1	71,9
COP net ⁽²⁾		3,60	3,45	3,27	3,51
Seasonal efficiencies - Cooling mode					
Seasonal Energy Efficiency Ratio - SEER ⁽³⁾		5,10	5,23	5,00	4,53
Seasonal energy efficiency - η_{s,c} ⁽⁴⁾	%	201	206	197	178
Eurovent energy efficiency class - Part load operation		A	A+	A	B
Seasonal efficiencies - Heating mode					
Seasonal Coefficient of Performance - SCOP ⁽⁵⁾		4,18	4,30	4,08	3,63
Seasonal energy efficiency - η_{s,h} ⁽⁶⁾	%	164	169	160	142
Eurovent energy efficiency class - Part load operation		A+	A+	A+	A
Ventilation data					
Minimum airflow rate	m ³ /h	26500	29000	33500	36500
Nominal airflow rate		33000	36000	41500	41500
Maximum airflow rate		41500	41500	41500	41500
Boosted airflow rate		49500	49500	49500	49500
Acoustic data - Standard unit					
Outdoor sound power	dB(A)	92	92	93	93
Indoor blower outlet sound power		91	94	98	93
Electrical data					
Maximum power	kW	102	109,4	122,1	136
Maximum current	A	326,4	421,8	443,5	465,2
Starting current	A	170,2	180,6	202,3	224,1
Short circuit current	kA	10	10	10	10
Refrigeration circuit					
Number of circuits		2	2	2	2
Number of compressors		4	4	4	4
Refrigerant load	kg	21,2/20,9	21,2/20,4	20,5/20,3	20,3/20
Unit weight					
Standard air cooled unit	kg	2058	2085	2114	2204

(1) **Cooling mode** : According to EN14511 nominal conditions - Outdoor temperature 35°C DB - Indoor temperature 27°C DB / 19°C WB

(2) **Heating mode** : According to EN14511 nominal conditions - Outdoor temperature 7°C DB / 6°C WB - Indoor temperature 20°C DB

(3) SEER in accordance with standard EN14825.

(4) Space cooling energy efficiency following Ecodesign regulation EU 2016/2281

(5) SCOP in accordance with standard EN 14825 (average climate conditions).

(6) Space heating energy efficiency following Ecodesign regulation EU 2016/2281.



Air cooled version

		100AH			125AH	185AH						270AH			
Evio		025	035	045	055	055	060	065	070	075	085	095	085	095	105
A	mm	2248	2248	2248	2248	2248	2248	2248	2248	2248	2248	2248	2248	2248	2248
B		2909	2909	2909	3916	4468	3461	4468	3461	4468	4468	4468	4468	4468	4468
C		1620	1620	1620	1620	1620	1620	1620	1620	1620	1620	1620	1620	2122	2122
Weight of standard units															
Basic unit	kg	677	705	735	910	1024	890	1068	893	1125	1161	1178	1260	1265	1316

		270AH			360AH						415AH				
Evio		115	130	145	115	130	145	160	180	200	180	200	225	250	
A	mm	2248	2248	2248	2248	2248	2248	2248	2248	2248	2248	2248	2248	2248	
B		4468	4468	4468	5030	5030	5030	5030	5030	5030	5454	5454	5454	5454	
C		2122	2122	2301	2122	2122	2301	2301	2301	2301	2301	2301	2301	2301	
Weight of standard units															
Basic unit	kg	1339	1365	1542	1494	1516	1679	1809	1918	1970	2058	2085	2114	2204	

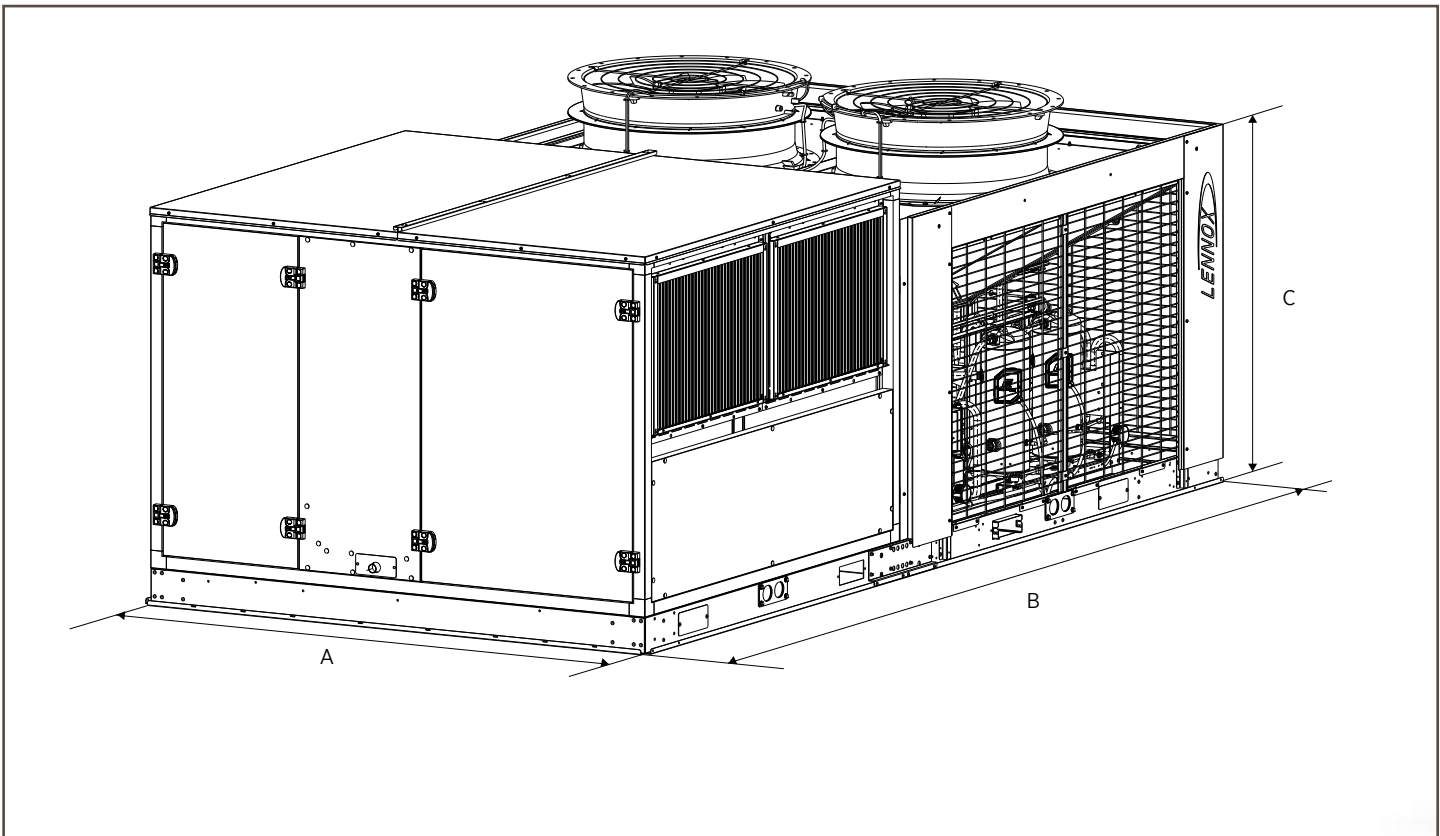

e-Baltic

Air cooled rooftop units





R32



AIR COOLED

 **31 - 207 kW**

 **30 - 207 kW**

 **5700 - 35000 m³/h**

LENNOX participates in the ECP
programme for RT.
Check ongoing validity of certificate :
www.eurovent-certification.com

- # Installation and replacement made easy thanks to the unit's **compact nature with the same footprint and weight** as previous Baltic and Flexair ranges.
- # Optimised design and integration of highly efficient components enabling **energy savings**.
- # **Flexibility** in capacity and airflow rates, ventilation options, energy sources and design (configurations and roof curbs) in order to best fit your application's needs.
- # **Low noise level** thanks to availability of several sound attenuation options.
- # **Reduced frequency of leak testing and lower taxes** thanks to a lower CO₂e (carbon dioxide equivalent).



R32 is an obvious choice to replace R410A. It already makes up 50% of its composition, and it has a number of other key advantages:

- # low GWP: 675
- # low cost
- # pure substance
- # many providers due to no patent



THERMODYNAMIC SYSTEM

- # R32 refrigerant (GWP = 675) enabling a decrease of the carbon dioxide equivalent for potential tax savings.
- # Tandem scroll compressors allowing capacity modulation.
- # Variable refrigerant control with electronic expansion valve.
- # Heat transfer efficiency thanks to new coil design.
- # Easy access to compressors enabling faster maintenance operations.
- # Fan with variable speed EC motor and swept blades, enabling control of the high and low floating pressure for optimum operation.
- # Integrated safety devices for peace of mind.

REMOTE MONITORING

- # Connectivity through **LennoxCloud** (LENNOX WEB PORTAL for Multi sites / Multi units).
- # BMS through: **e-savvy**



CONTROL

- # eCLIMATIC electronic controller and intelligent control parameters optimising part-load efficiency.
- # Integrated communication solutions offering flexibility (master/slave, Modbus, BACnet).
- # Several display solutions for different access levels.

eCLIMATIC



DS

Service display



DM

Multi-Rooftop display



DC

Comfort display



CASING & DESIGN

- # New design enabling a -30% refrigerant charge.
- # Pre-coated steel or aluminum panels painted in RAL 9003 color, specially designed for corrosion resistance and to ensure long operation lifetime.
- # Compact design for perfect integration in its environment.
- # Same footprint as previous models for plug & play replacement.
- # Inclined removable drain pan in aluminum for easy disinfecting.
- # Double skin panels are available as an option.

HEAT RECOVERY

- # Thermodynamic heat recovery, ideal for mild climates.
- # Plate heat exchanger, to improve the system's efficiency in colder climates by preheating the fresh air stream.
- # Heat recovery wheel, with both fresh and return air sections protected by G4 filters.
- # eRecovery, to recover free heat produced by food refrigeration systems.

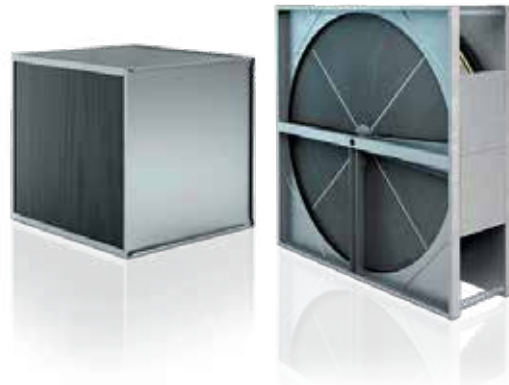

AIR TREATMENT

- # EC motor fans ensuring a precise temperature for better comfort and energy savings.
- # IAQ kits for improved indoor air quality within the building:
 - Media filters (F7/ePM1 50%, M5/ePM10 50%).
 - UV-C lamps.
 - Ionization.



AIRFLOW

- # Several available airflow configurations: top, bottom or horizontal, to fit each building's need.
- # Adaptable roof curb to fit the building's architecture:
 - Adjustable roof curb.
 - Multidirectional roof curb.
 - Vertical exhaust roof curb.
 - Non adjustable, non assembled (only available outside the EU).

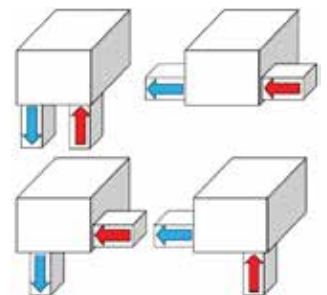

AUXILIARY HEATING DEVICES

- # Different options depending on the energy source available on site:
 - Hot water coil.
 - Condensing gas burner.
 - Electric heater.
 - Electric preheater.

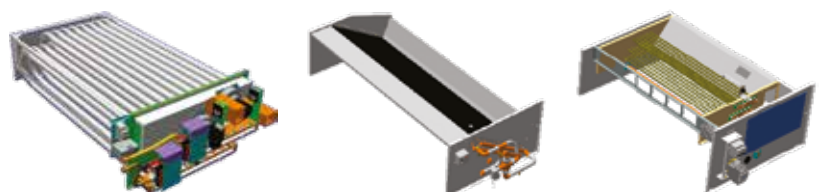

eB^(A) B^(B) H^(C) 100^(D) D^(E) P^(F) 1^(G) M^(H)

- (A) **eB** = e-Baltic
- (B) **B** = Steel - **F** = Aluminium
- (C) **H** = Heat pump unit
- (D) Cooling capacity in kW (x 100 m³/h)
- (E) **S** = 1 circuit - **D** = 2 circuits
- (F) **P** = R32 - **H** = HFO - **N** = No refrigerant
- (G) Revision number
- (H) 400V/3/50Hz



Air cooled version



Heat pump units

e-Baltic		035	045	055	065	075	085	095
Nominal thermal performances - Cooling mode								
Cooling capacity ⁽¹⁾	kW	31,3	43,0	45,9	57,6	66,7	81,0	98,4
Total Power Input	kW	9,50	13,86	14,89	19,86	22,48	28,44	30,37
EER net ⁽¹⁾		3,30	3,10	3,08	2,90	2,97	2,85	3,24
Nominal thermal performances - Heating mode								
Heating capacity ⁽²⁾	kW	29,7	37,2	43,0	56,5	64,3	83,0	92,7
Total Power Input	kW	7,94	10,54	12,61	16,57	18,71	25,80	24,14
COP net ⁽²⁾		3,74	3,53	3,41	3,41	3,44	3,22	3,84
Seasonal efficiencies - Cooling mode								
Seasonal Energy Efficiency Ratio - SEER ⁽³⁾		4,41	4,41	3,99	3,93	3,98	3,71	4,51
Seasonal energy efficiency - η_{s,c} ⁽⁴⁾	%	173	173	157	154	156	145	177
Eurovent energy efficiency class - Part load operation		B	B	B	B	B	B	B
Seasonal efficiencies - Heating mode								
Seasonal Coefficient of Performance - SCOP ⁽⁵⁾		3,48	3,29	3,45	3,26	3,52	3,26	3,38
Seasonal energy efficiency - η_{s,h} ⁽⁶⁾	%	136,2	128,6	135	127,7	137,8	127,4	132,2
Eurovent energy efficiency class - Part load operation		B	B	B	B	B	B	B
Auxiliary heating								
Gas heating capacity	kW	33,9	33,9	57,2	57,2	74,1	74,1	101,5
Electric heater capacity - Standard / High		18 / 36	18 / 36	27 / 54	27 / 54	27 / 54	27 / 54	27 / 54
Electric pre-heater capacity - Standard / High		18 / 36	18 / 36	24 / 48	24 / 48	36 / 72	36 / 72	36 / 72
Hot water coil capacity Air inlet 10°C/Water 90-70°C		Capacity depends on air and water conditions.						
Ventilation data								
Minimum airflow rate	m ³ /h	4200	4500	5000	6600	9500	9600	12300
Nominal airflow rate		7000	7500	8000	11000	13500	16000	20500
Maximum airflow rate		8000	10000	11200	16000	22000	22000	23000
Acoustic data - Standard unit								
Outdoor sound power	dB(A)	82	83	74,1	76,4	79,0	81,7	81,4
Indoor blower outlet sound power		80,2	81,5	75,5	80,8	82,2	86,2	85,2
Electrical data								
Maximum power	kW	14,5	21,3	22,6	26,6	33,3	37,9	47,8
Maximum current	A	24,5	34,2	98,4	102,6	118,3	130,4	162,7
Starting current	A	82,2	112,1	39,3	44,9	56,0	63,4	75,8
Short circuit current	kA	10	10	10	10	10	10	10
Refrigeration circuit								
Number of circuits		1	1	2	2	2	2	2
Number of compressors		2	2	4	4	4	4	4
Refrigerant load	kg	5.1	6.75	6.2 / 6.2	6.2 / 6.2	5.7 / 5.7	5.7 / 5.7	7.7 / 7.7

- (1) **Cooling mode** : According to EN14511 nominal conditions - Outdoor temperature 35°C DB - Indoor temperature 27°C DB / 19°C WB
- (2) **Heating mode** : According to EN14511 nominal conditions - Outdoor temperature 7°C DB / 6°C WB - Indoor temperature 20°C DB
- (3) SEER in accordance with standard EN14825.
- (4) Space cooling energy efficiency following Ecodesign regulation EU 2016/2281
- (5) SCOP in accordance with standard EN 14825 (average climate conditions).
- (6) Space heating energy efficiency following Ecodesign regulation EU 2016/2281.

eB^(A) B^(B) H^(C) 100^(D) D^(E) P^(F) 1^(G) M^(H)

- (A) **eB** = e-Baltic
 (B) **B** = Steel - **F** = Aluminium
 (C) **H** = Heat pump unit
 (D) Cooling capacity in kW (x 100 m³/h)
 (E) **S** = 1 circuit - **D** = 2 circuits
 (F) **P** = R32 - **H** = HFO - **N** = No refrigerant
 (G) Revision number
 (H) 400V/3/50Hz



Air cooled version



Heat pump units

e-Baltic		100	115	120	130	150	180	210
Nominal thermal performances - Cooling mode								
Cooling capacity ⁽¹⁾	kW	97,5	117,1	117,7	134,7	150,2	180,0	206,7
Total Power Input	kW	31,05	38,52	38,59	45,36	51,09	57,51	71,27
EER net ⁽¹⁾		3,14	3,04	3,05	2,97	2,94	3,13	2,90
Nominal thermal performances - Heating mode								
Heating capacity ⁽²⁾	kW	93,5	114,0	115,0	129,3	145,9	172,9	207,0
Total Power Input	kW	24,60	31,84	32,86	34,95	41,10	45,86	59,65
COP net ⁽²⁾		3,80	3,58	3,50	3,70	3,55	3,77	3,47
Seasonal efficiencies - Cooling mode								
Seasonal Energy Efficiency Ratio - SEER ⁽³⁾		4,50	4,26	4,20	4,29	4,23	4,31	3,81
Seasonal energy efficiency - η_{s,c} ⁽⁴⁾	%	177	167	165	169	166	169	149
Eurovent energy efficiency class - Part load operation		B	B	B	B	B	B	B
Seasonal efficiencies - Heating mode								
Seasonal Coefficient of Performance - SCOP ⁽⁵⁾		3,4	3,37	3,34	3,39	3,39	3,4	3,35
Seasonal energy efficiency - η_{s,h} ⁽⁶⁾	%	133	131,8	130,6	132,6	132,6	133	131
Eurovent energy efficiency class - Part load operation		B	B	B	B	B	B	B
Auxiliary heating								
Gas heating capacity	kW	95,4	101,5	95,4	139,2	139,2	172,9	172,9
Electric heater capacity - Standard / High		30 / 72	27 / 54	30 / 72	45 / 108	45 / 108	72 / 162	72 / 162
Electric pre-heater capacity - Standard / High		-	36 / 72	-	-	-	-	-
Hot water coil capacity Air inlet 10°C/Water 90-70°C		Capacity depends on air and water conditions.						
Ventilation data								
Minimum airflow rate	m ³ /h	15000	13800	15700	19000	21000	24000	28000
Nominal airflow rate		20500	23000	23000	26000	28000	33000	35000
Maximum airflow rate		23000	23000	23000	35000	35000	43000	43000
Acoustic data - Standard unit								
Outdoor sound power	dB(A)	81,4	83,2	83,7	84,5	86,4	85,7	87,5
Indoor blower outlet sound power		85,2	87,7	87,7	89,4	91,0	88,6	89,8
Electrical data								
Maximum power	kW	47,9	55,8	56,3	62,6	68,8	82,0	98,6
Maximum current	A	162,9	212,6	213,5	202,8	230,2	273,8	328,7
Starting current	A	76,0	93,6	94,5	98,4	108,6	129,4	155,4
Short circuit current	kA	10	10	10	10	10	10	10
Refrigeration circuit								
Number of circuits		2	2	2	2	2	2	2
Number of compressors		4	4	4	4	4	4	4
Refrigerant load	kg	7.3 / 7.3	7.8 / 7.8	7.4 / 7.4	11.25 / 10.5	11.25 / 10.5	12.8 / 12.8	13.5 / 13.5

(1) **Cooling mode** : According to EN14511 nominal conditions - Outdoor temperature 35°C DB - Indoor temperature 27°C DB / 19°C WB

(2) **Heating mode** : According to EN14511 nominal conditions - Outdoor temperature 7°C DB / 6°C WB - Indoor temperature 20°C DB

(3) SEER in accordance with standard EN14825.

(4) Space cooling energy efficiency following Ecodesign regulation EU 2016/2281

(5) SCOP in accordance with standard EN 14825 (average climate conditions).

(6) Space heating energy efficiency following Ecodesign regulation EU 2016/2281.



Air cooled version

e-Baltic		035	045	055	065	075	085	095	100	115	120	130	150	180	210
A	mm	2250	2250	2250	2250	2250	2250	2305	2245	2305	2245	2245	2245	2260	2260
B		2298	2298	2811	2811	3691	3691	3691	3315	3691	3315	4360	4360	5166	5166
C		1263	1263	1263	1263	1263	1263	1619	1750	1619	1750	1885	1885	2235	2235
D		435	435	435	435	435	435	435	360	435	360	456	456	620	620
Weight of standard units															
Basic unit	kg	640	640	980	980	1150	1150	1300	1300	1300	1350	1700	1700	2150	2150

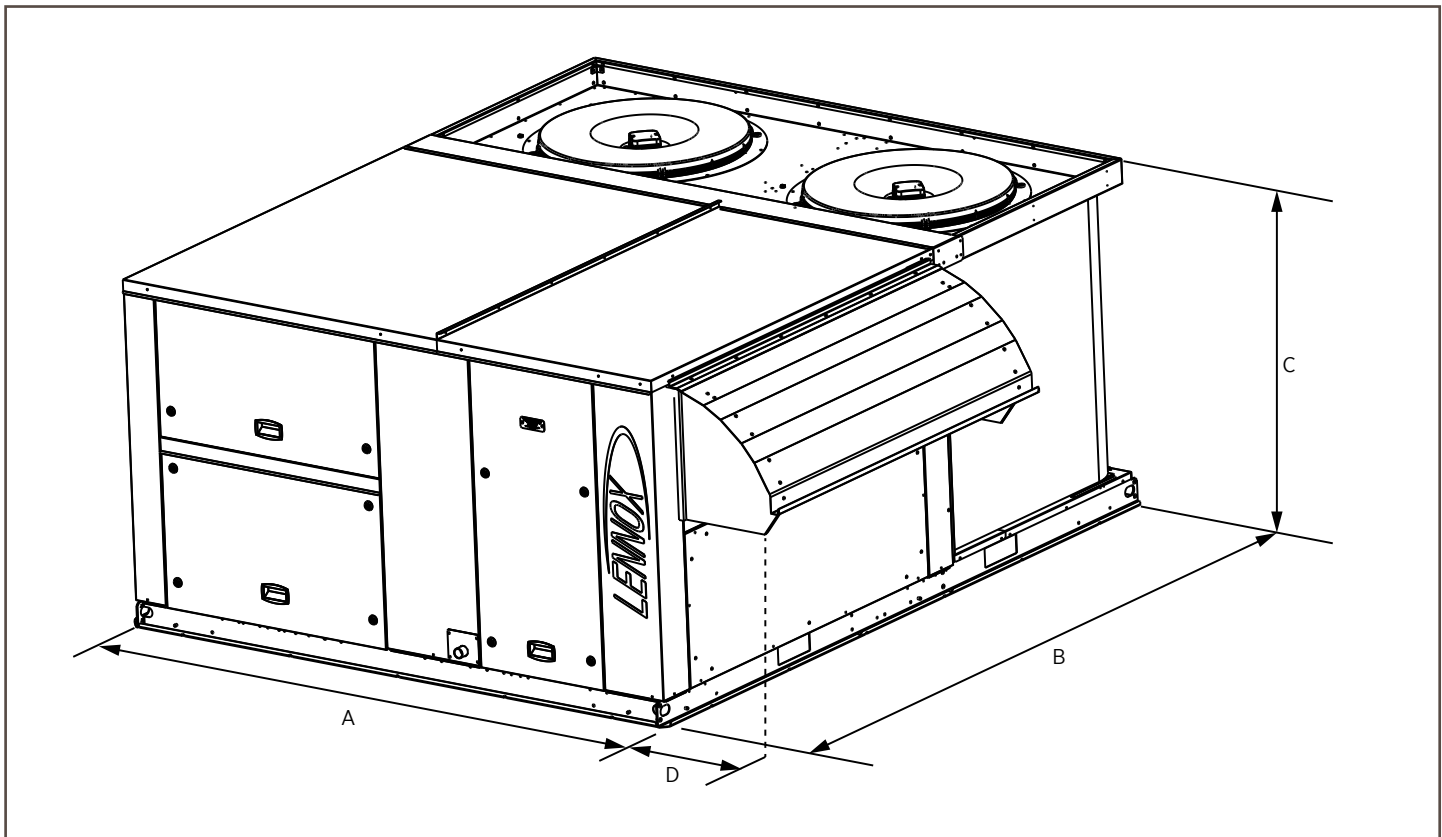

Baltic

Air and water cooled rooftop units





R410A



AIR COOLED

 **22 - 122 kW**

 **21 - 115 kW**

 **4200 - 23500 m³/h**

WATER COOLED

 **47 - 90 kW**

 **60 - 117 kW**

 **7100 - 14500 m³/h**

LENNOX participates in the ECP
programme for RT.
Check ongoing validity of certificate :
www.eurovent-certification.com

- # Installation and replacement made easy thanks to the unit's **compact nature with the same footprint and weight** as previous models.
- # Optimised design and integration of highly efficient components enabling **energy savings**.
- # **Flexibility** in capacity and airflow rates, ventilation options, energy sources and design (configurations and roof curbs) in order to best fit your application's needs.
- # **Low noise level** thanks to availability of several sound options.

THERMODYNAMIC SYSTEM

- # Tandem scroll compressors allowing capacity modulation.
- # Variable refrigerant control with electronic expansion valve.
- # Easy access to compressors enabling faster maintenance operations.
- # Variable speed EC axial fans with swept blades for improved efficiency.



REMOTE MONITORING

- # Connectivity through **LennoxCloud** (LENNOX WEB PORTAL for Multi sites / Multi units).
- # BMS through: **e-savvy**



CONTROL

- # eCLIMATIC electronic controller and intelligent control parameters optimising part-load efficiency.
- # Integrated communication solutions offering flexibility (master/slave, Modbus, BACnet).
- # Several display solutions for different access levels.

eCLIMATIC



DS

Service display



DM

Multi-Rooftop display



DC

Comfort display



CASING & DESIGN

- # Pre-coated steel or aluminum panels painted in RAL 9003 color, specially designed for corrosion resistance and to ensure long operation lifetime.
- # Compact design for perfect integration in its environment.
- # Same footprint as previous models for plug & play replacement.
- # Inclined removable drain pan in aluminum for easy disinfecting.
- # Double skin panels are available as an option.

HEAT RECOVERY

- # Thermodynamic heat recovery, ideal for mild climates.
- # Plate heat exchanger, to improve the system's efficiency in colder climates by preheating the fresh air stream.
- # Heat recovery wheel, with both fresh and return air sections protected by G4 filters.
- # eRecovery, to recover free heat produced by food refrigeration systems.



AIR TREATMENT

- # EC motor fans ensuring a precise temperature for better comfort and energy savings.
- # IAQ kits for improved indoor air quality within the building:
 - Media filters (F7/ePM1 50%, M5/ePM10 50%).
 - UV-C lamps.
 - Ionization.



AIRFLOW

- # Several available airflow configurations: top, bottom or horizontal, to fit each building's need.
- # Adaptable roof curb to fit the building's architecture:
 - Adjustable roof curb.
 - Multidirectional roof curb.
 - Vertical exhaust roof curb.
 - Non adjustable, non assembled (only available outside the EU).

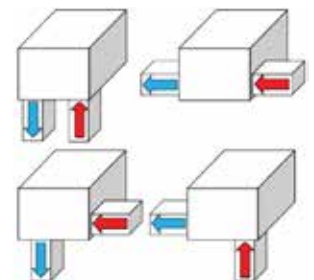

AUXILIARY HEATING DEVICES

- # Different options depending on the energy source available on site:
 - Hot water coil.
 - Condensing gas burner.
 - Electric heater.
 - Electric preheater.

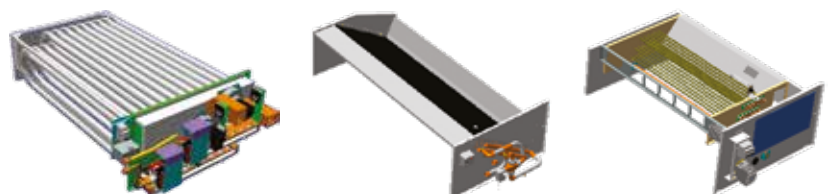

BA^(A) C^(B) 065^(C) D^(D) N^(E) M^(F) 5^(G) M^(H)

- (A) BA = BALTIC
- (B) C = Cooling - H = Heat pump
- (C) Cooling capacity in kW or airflow (x 1.000 m³/h)
- (D) S = 1 circuit - D = 2 circuits - T = 3 circuits - F = 4 circuits
- (E) H = High heat - S = Standard heat - N = No heat
- (F) M = R410A - H = HFO - Z = No refrigerant
- (G) Revision number
- (H) 400V/III/50Hz



Air cooled version



Heat pump units

BALTIC		025	030	040	042	045	055	057	065	075	085	095	115	125	
Nominal thermal performances - Cooling mode															
Cooling capacity ⁽¹⁾	kW	22,3	27,7	36,6	40,3	44,3	49,9	55,2	62,6	73,5	82,0	100,5	114,9	122,2	
Total Power Input	kW	6,41	8,59	11,74	13,87	12,84	14,90	16,70	20,24	22,81	26,64	31,24	37,28	41,06	
EER net ⁽¹⁾		3,48	3,22	3,12	2,90	3,45	3,35	3,30	3,09	3,22	3,08	3,22	3,08	2,98	
Nominal thermal performances - Heating mode															
Heating capacity ⁽²⁾	kW	20,9	25,7	34,6	38,3	40,4	45,0	53,7	60,8	70,7	78,3	95,6	107,5	114,8	
Total Power Input	kW	5,59	7,10	9,97	11,34	11,57	13,07	14,87	17,97	21,45	24,41	26,98	31,73	35,37	
COP net ⁽²⁾		3,74	3,62	3,47	3,38	3,49	3,44	3,61	3,38	3,30	3,21	3,54	3,39	3,24	
Seasonal efficiencies - Cooling mode															
Seasonal Energy Efficiency Ratio - SEER ⁽³⁾		4,44	4,26	4	3,85	4,93	4,71	4,66	4,5	4,36	4,21	4,33	4,26	4,18	
Seasonal energy efficiency - η _{s,c} ⁽⁴⁾	%	175	167	157	151	194	186	184	177	172	166	170	168	164	
Eurovent energy efficiency class - Part load operation		B	B	B	B	B	B	B	B	B	B	B	B	B	
Seasonal efficiencies - Heating mode															
Seasonal Coefficient of Performance - SCOP ⁽⁵⁾		3,49	3,4	3,27	3,21	3,33	3,29	3,32	3,3	3,21	3,22	3,4	3,33	3,2	
Seasonal energy efficiency - η _{s,h} ⁽⁶⁾	%	137	133	128	126	130	129	130	129	126	126	133	130	126	
Eurovent energy efficiency class - Part load operation		B	B	B	B	A	A	B	B	B	B	B	B	B	
Auxiliary heating															
Gas heating capacity	kW	33,9				57,2				74,1			101,5		
Electric heater capacity - Standard / High		18/36				27/54				27/54			27/54		
Electric pre-heater capacity - Standard / High		18/36				24/48				36/72			36/72		
Hot water coil capacity Air inlet 10°C/Water 90-70°C		50	59	63	66	84	93	103	109	178	186	186	186	186	
Ventilation data															
Minimum airflow rate	m ³ /h	3500	3500	3780	4140	5000	5000	5940	6600	9500	9500	12900	13800	14700	
Nominal airflow rate		4200	5700	6300	6900	7100	8300	9900	11100	13500	14500	19500	22000	23500	
Maximum airflow rate		5600	6800	10000	10000	9700	11200	16000	16000	22000	22000	23000	23000	24500	
Acoustic data - Standard unit															
Outdoor sound power	dB(A)	80,2	80,7	81,4	81,9	83,3	83,5	84,1	84,5	81,9	83,2	82,6	84,6	87,3	
Indoor blower outlet sound power		71	77,3	79,4	81,4	72,1	74,5	77,6	80	83,1	84,5	84,1	86,7	88,2	
Electrical data															
Maximum power	kW	13	15,3	18,3	20,3	25,8	28,1	30,2	33,3	40,6	44,6	49,8	55,8	60,5	
Maximum current	A	56,7	66,3	93,2	121,4	77,3	87	89	116	129,2	161,9	192,4	212,9	220,9	
Starting current	A	21,2	23,4	30,3	34,7	41,8	44	46,1	53	66,3	75,2	81,6	94,1	102	
Short circuit current	kA	10				10				10			10		
Refrigeration circuit															
Number of circuits		1	1	1	1	2	2	2	2	2	2	2	2	2	
Number of compressors		2	2	2	2	4	4	4	4	4	4	4	4	4	
Refrigerant load	kg	6,1	6,1	8,1	8,1	6,5 +6,5	6,5 +6,5	8 +8	8 +8	10,5 +10,5	10,5 +10,5	10 +10	10,4 +10,4	10,8 +10,8	

(1) **Cooling mode** : According to EN14511 nominal conditions - Outdoor temperature 35°C DB - Indoor temperature 27°C DB / 19°C WB
 (2) **Heating mode** : According to EN14511 nominal conditions - Outdoor temperature 7°C DB / 6°C WB - Indoor temperature 20°C DB
 (3) SEER in accordance with standard EN14825.
 (4) Space cooling energy efficiency following Ecodesign regulation EU 2016/2281
 (5) SCOP in accordance with standard EN 14825 (average climate conditions).
 (6) Space heating energy efficiency following Ecodesign regulation EU 2016/2281.

BA^(A) C^(B) 065^(C) D^(D) N^(E) M^(F) 5^(G) M^(H)

(A) **BA** = BALTIC

(B) **C** = Cooling - **H** = Heat pump

(C) Cooling capacity in kW or airflow (x 1.000 m³/h)

(D) **S** = 1 circuit - **D** = 2 circuits - **T** = 3 circuits - **F** = 4 circuits

(E) **H** = High heat - **S** = Standard heat - **N** = No heat

(F) **M** = R410A - **H** = HFO - **Z** = No refrigerant

(G) Revision number

(H) 400V/III/50Hz



Water cooled version

Heat pump units

BALTIC		045	055	057	065	075	085
Nominal thermal performances - Cooling mode							
Cooling capacity ⁽¹⁾	kW	47,6	53,2	61,3	71,3	84,7	90,7
Total Power Input	kW	10,7	12,6	13,7	16,9	19,9	23,0
EER net ⁽¹⁾		4,5	4,2	4,5	4,2	4,2	3,9
Nominal thermal performances - Heating mode							
Heating capacity ⁽²⁾	kW	60,2	68,2	79,2	91,3	106,5	117,1
Total Power Input	kW	13,1	14,6	16,8	20,7	22,8	26,7
COP net ⁽²⁾		4,6	4,7	4,7	4,4	4,7	4,4
Seasonal efficiencies - Cooling mode							
Seasonal Energy Efficiency Ratio - SEER ⁽³⁾		5.08	5.88	6.43	5.93	5.39	5.26
Seasonal energy efficiency - η_{s,c} ⁽⁴⁾	%	195	227.4	249.4	229.3	207.7	202.3
Eurovent energy efficiency class - Part load operation		B	B	B	B	B	B
Seasonal efficiencies - Heating mode							
Seasonal Coefficient of Performance - SCOP ⁽⁵⁾		2.94	3.44	4.79	4.55	4.41	4.25
Seasonal energy efficiency - η_{s,h} ⁽⁶⁾	%	109.5	129.4	183.6	174.1	168.3	161.8
Eurovent energy efficiency class - Part load operation		B	B	B	B	B	B
Auxiliary heating							
Gas heating capacity	kW	57,2				74,1	
Electric heater capacity - Standard / High		27/54				27/54	
Electric pre-heater capacity - Standard / High		24/48				36/72	
Hot water coil capacity Air inlet 10°C/Water 90-70°C		84	93	103	109	178	186
Ventilation data							
Minimum airflow rate	m ³ /h	5000	5000	5940	6660	9500	9500
Nominal airflow rate		7100	8300	9900	11100	13500	14500
Maximum airflow rate		9700	11200	16000	16000	22000	22000
Acoustic data - Standard unit							
Outdoor sound power	dB(A)	74,4	75,5	77,2	78,8	81,6	82,9
Indoor blower outlet sound power		75,2	78	81,4	83,6	87	88,5
Electrical data							
Maximum power	kW	22,1	25,2	28,4	31,5	39,6	43,7
Maximum current	A	124	126,9	86	113	127,7	160,4
Starting current	A	37,3	40,2	43,1	50	64,8	73,7
Short circuit current	kA	10				10	
Refrigeration circuit							
Number of circuits		2	2	2	2	2	2
Number of compressors		2	3	4	4	4	4
Refrigerant load	kg	6.8 +6.8	6.8 +6.8	7.8 +7.8	7.8 +7.8	9.1 +9.1	9.1 +9.1

(1) **Cooling mode** : According to EN14511 nominal conditions

(2) **Heating mode** : According to EN14511 nominal conditions

(3) SEER in accordance with standard EN14825.

(4) Space cooling energy efficiency following Ecodesign regulation EU 2016/2281

(5) SCOP in accordance with standard EN 14825 (average climate conditions).

(6) Space heating energy efficiency following Ecodesign regulation EU 2016/2281



Air cooled version

BALTIC BAC/BAH		025	030	040	042	045	055	057	065	075	085	095	115	125
A	mm	2298				2811			3691		3691			
B		2250				2250			2250		2305			
C		1263				1263			1263		1619			
D		435												
Weight of standard units														
Basic unit	kg	600	620	660	660	860	860	920	920	1150	1150	1350	1350	1350



Water cooled version

BALTIC BAC/BAH		045	055	057	065	075	085	
A	mm	2798				3298		
B		2250				2250		
C		1263				1263		
D		435						
Weight of standard units								
Basic unit	kg	800	820	860	880	1000	1050	

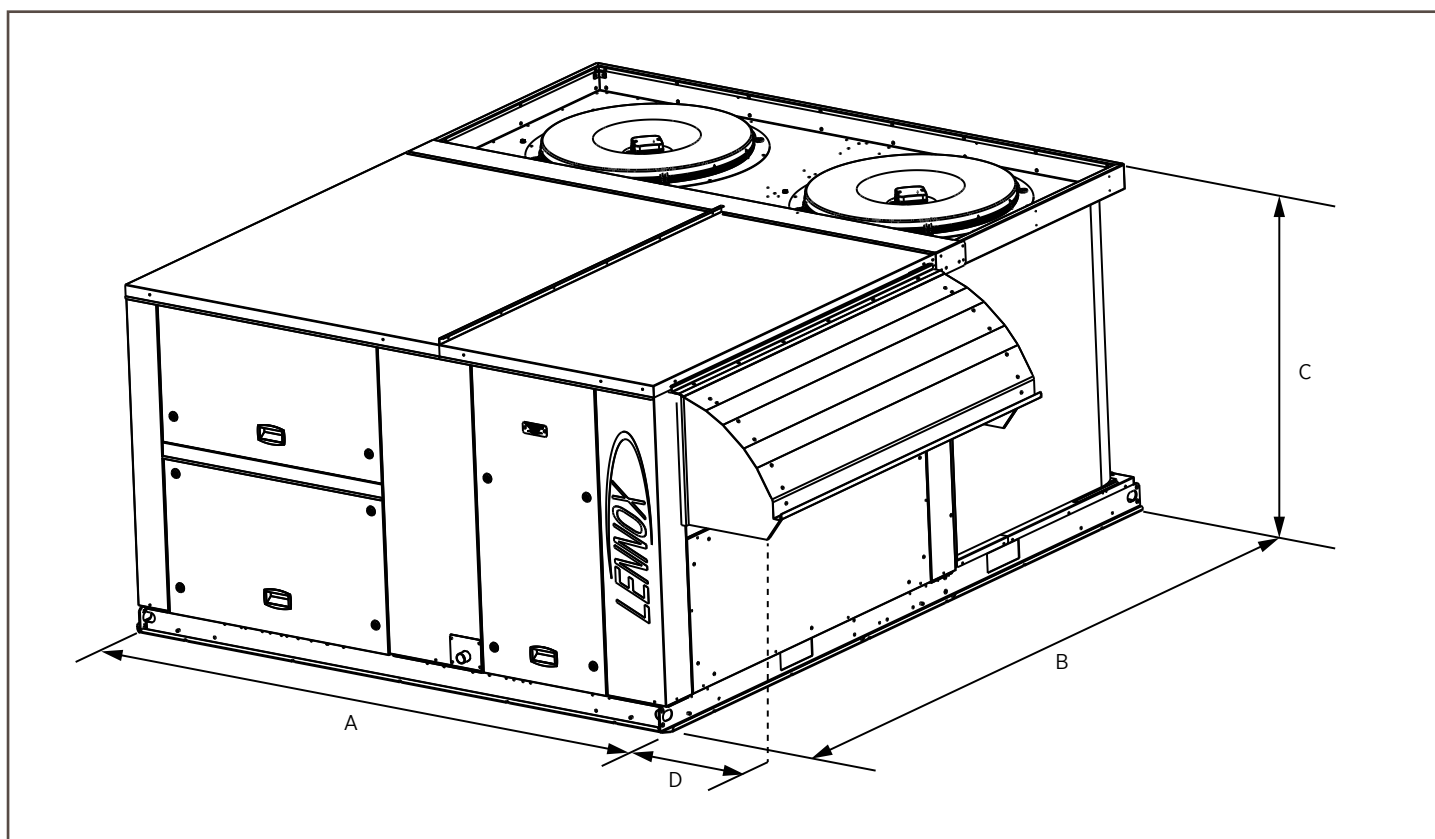

Flexair

Air cooled and water cooled rooftop units



R410A

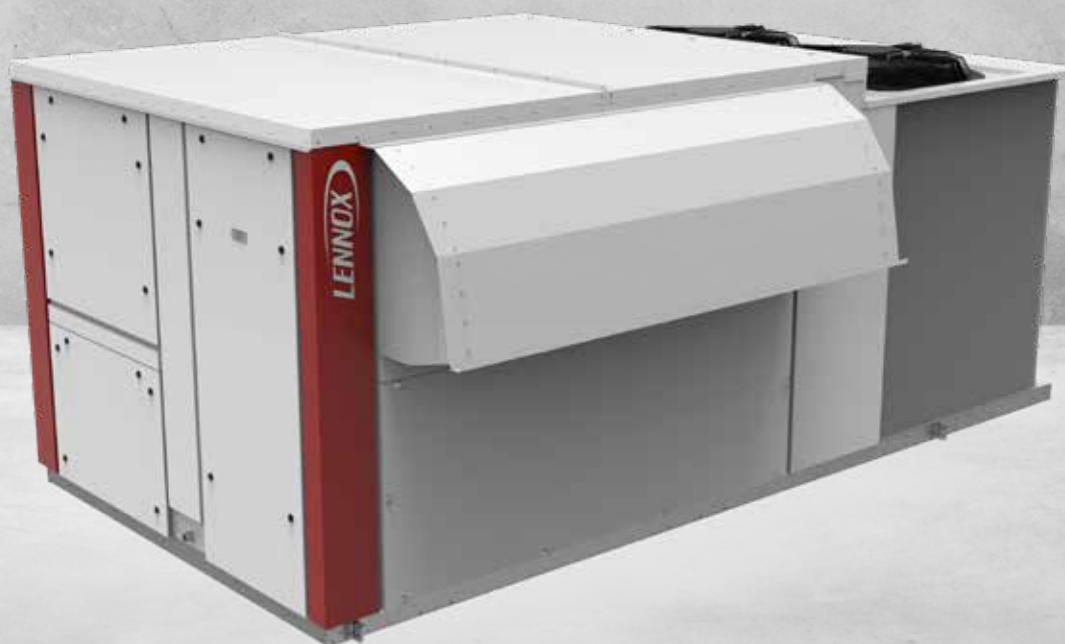

AIR COOLED

 **85 - 217 kW**

 **79 - 222 kW**

 **15000 - 39000 m³/h**

WATER COOLED

 **85 - 170 kW**

 **112 - 127 kW**

 **15000 - 30000 m³/h**

LENNOX participates in the ECP programme for RT.
Check ongoing validity of certificate :
www.eurovent-certification.com

- # Installation and replacement made easy thanks to the unit's **compact nature with the same footprint** and **weight** as previous models.
- # Optimised design and integration of highly efficient components enabling **energy savings**.
- # **Flexibility** in capacity and airflow rates, ventilation options, energy sources and design (configurations and roof curbs) in order to best fit your application's needs.
- # **Low noise level** thanks to availability of several sound attenuation options.

CASING & DESIGN

- # Pre-coated aluminum panels painted in RAL 9003 colour, specially designed for corrosion resistance and to ensure long operation lifetime.
- # Condensing section mounted in a rigid base frame to ensure good support for compressors and giving rigidity to the complete structure.
- # Same footprint as previous models for plug & play replacement.
- # Double skin panels are available as an option.
- # Inclined removable drain pan in aluminum for easy disinfecting.

AIRFLOW

- # Several available airflow configurations: top, bottom or horizontal, to fit each building's need.
- # Adaptable roof curb to fit the building's architecture:
 - Adjustable roof curb.
 - Multidirectional roof curb.
 - Vertical exhaust roof curb.
 - Non adjustable, non assembled (only available outside the EU).

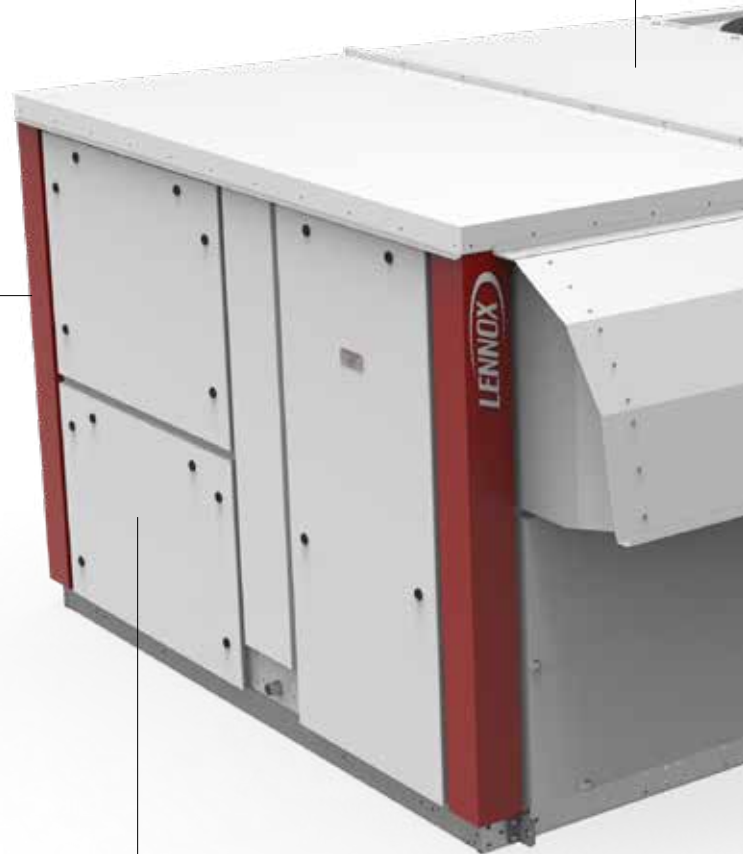
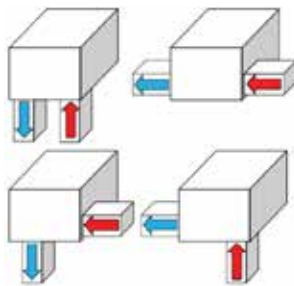

AUXILIARY HEATING DEVICES

- # Different options depending on the energy source available on site:
 - Hot water coil.
 - Condensing gas burner.
 - Electric heater.

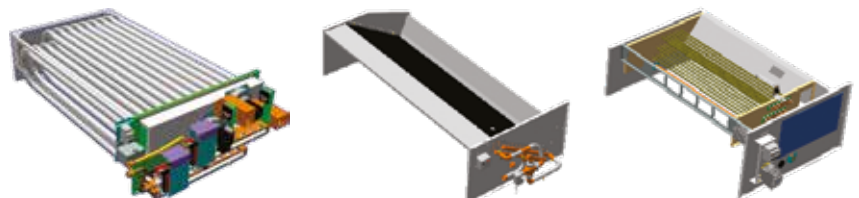

REMOTE MONITORING

- # Connectivity through **LennoxCloud** (LENNOX WEB PORTAL for Multi sites / Multi units).
- # BMS through: **e-savvy**

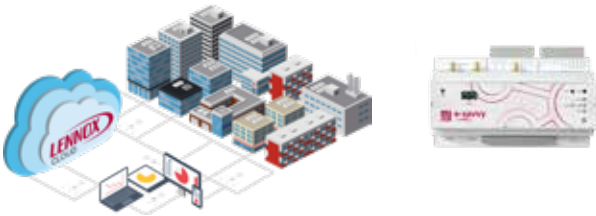

CONTROL

- # Climatic60 electronic controller and intelligent control parameters optimising part-load efficiency.
- # Integrated communication solutions offering flexibility (master/slave, Modbus, BACnet).
- # Several display solutions for different access levels.



THERMODYNAMIC SYSTEM

- # Tandem scroll compressors allowing capacity modulation.
- # Variable refrigerant control with electronic expansion valve.
- # Easy access to compressors enabling faster maintenance operations.
- # Variable speed EC axial fans with swept blades for improved efficiency.



AIR TREATMENT

- # EC motor fans ensuring a precise temperature for better comfort and energy savings.
- # Analogue filter detection to inform when the filters must be changed.
- # IAQ kits for improved indoor air quality within the building:
 - G4 (standard)
 - G4+F7 (ePM1 85%)
 - G4+F7+F9 (ePM1 95%)
 - UV-C lamps.
 - Ionization.



HEAT RECOVERY

- # Heat recovery wheel, with both fresh and return air sections protected by G4 filters.
- # eRecovery, to recover free heat produced by food refrigeration systems.

FA^(A) C^(B) 100^(C) D^(D) N^(E) M^(F) 2^(G) M^(H)

- (A) **FA** = Flexair
- (B) **C** = Cooling only unit - **H** = Heat pump unit
- (C) Cooling capacity in kW
- (D) **S** = 1 circuit - **D** = 2 circuits - **T** = 3 circuits - **F** = 4 circuits
- (E) **H** = High heat - **S** = Standard heat - **N** = No heat
- (F) **M** = R410A - **H** = HFO - **N** = No refrigerant
- (G) Revision number
- (H) **M** = 400V/3/50Hz - **T** = 230V/1/50Hz



Air cooled version



Cooling only units

Flexair		090	100	120	150	170	200	230
Nominal thermal performances - Cooling mode								
Cooling capacity ⁽¹⁾	kW	84.70	105.30	117.00	131.40	153.90	178.30	216.10
Total Power Input	kW	23.40	32.10	37.50	48.13	57.21	59.43	76.09
EER net ⁽¹⁾		3.62	3.28	3.12	2.73	2.69	3.00	2.84
Nominal thermal performances - Heating mode								
Heating capacity ⁽²⁾	kW	-	-	-	-	-	-	-
Total Power Input	kW	-	-	-	-	-	-	-
COP net ⁽²⁾		-	-	-	-	-	-	-
Seasonal efficiencies - Cooling mode								
Seasonal Energy Efficiency Ratio - SEER ⁽³⁾		4.11	3.95	3.64	4.17	4.02	4.02	4.01
Seasonal energy efficiency - η_{s,c} ⁽⁴⁾	%	161.40	155.00	142.60	163.80	157.80	157.80	157.40
Eurovent energy efficiency class - Part load operation		B	B	B	B	B	B	B
Seasonal efficiencies - Heating mode								
Seasonal Coefficient of Performance - SCOP ⁽⁵⁾		-	-	-	-	-	-	-
Seasonal energy efficiency - η_{s,h} ⁽⁶⁾	%	-	-	-	-	-	-	-
Eurovent energy efficiency class - Part load operation		-	-	-	-	-	-	-
Auxiliary heating								
Gas heating capacity - Standard / High	kW	60 / 120	60 / 120	60 / 120	120 / 180	120 / 180	180 / 240	180 / 240
Electric heater capacity - Standard / High		30 / 72	30 / 72	30 / 72	45 / 108	45 / 108	72 / 162	72 / 162
Electric pre-heater capacity - Standard / High		-	-	-	-	-	-	-
Hot water coil capacity Air inlet 20°C/Water		114 / 177	126 / 201	133 / 212	145 / 254	156 / 275	177 / 295	186 / 313
Ventilation data								
Minimum airflow rate	m ³ /h	12000	14800	15000	18000	21000	24000	24000
Nominal airflow rate		15000	18500	22000	26500	28000	33000	35000
Maximum airflow rate		23000	23000	23000	35000	35000	43000	43000
Acoustic data - Standard unit								
Outdoor sound power	dB(A)	83	88	92	86	88	89	93
Indoor blower outlet sound power		85,9	91,0	95,3	91,4	91,7	88,5	89,8
Electrical data								
Maximum power	kW	44,7	52,3	56,7	64,6	78,8	88,7	102,8
Maximum current	A	159,3	170,9	194,0	204,6	249,0	296,0	313,6
Starting current	A	75,5	86,9	98,9	106,2	133,0	152,0	169,6
Short circuit current	kA	10						
Refrigeration circuit								
Number of circuits		2						
Number of compressors		2			4			
Refrigerant load	kg	8,2 / 8,2	8,5 / 9,5	9,5 / 9,5	14,5 / 14,8	13,75/13,25	18,5 / 18,5	19,8 / 19,8

- (1) **Cooling mode** : According to EN14511 nominal conditions - Outdoor temperature 35°C DB - Indoor temperature 27°C DB / 19°C WB
- (2) **Heating mode** : According to EN14511 nominal conditions - Outdoor temperature 7°C DB / 6°C WB - Indoor temperature 20°C DB
- (3) SEER in accordance with standard EN14825.
- (4) Space cooling energy efficiency following Ecodesign regulation EU 2016/2281
- (5) SCOP in accordance with standard EN 14825 (average climate conditions).
- (6) Space heating energy efficiency following Ecodesign regulation EU 2016/2281.

FA^(A) H^(B) 100^(C) D^(D) N^(E) M^(F) 2^(G) M^(H)

(A) **FA** = Flexair

(B) **C** = Cooling only unit - **H** = Heat pump unit

(C) Cooling capacity in kW

(D) **S** = 1 circuit - **D** = 2 circuits - **T** = 3 circuits - **F** = 4 circuits

(E) **H** = High heat - **S** = Standard heat - **N** = No heat

(F) **M** = R410A - **H** = HFO - **N** = No refrigerant

(G) Revision number

(H) **M** = 400V/3/50Hz - **T** = 230V/1/50Hz



Air cooled version



Heat pump units

Flexair		090	100	120	150	170	200	230
Nominal thermal performances - Cooling mode								
Cooling capacity ⁽¹⁾	kW	80.51	97.98	108.73	129.60	152.80	175.20	203.60
Total Power Input	kW	24.55	31.81	36.98	47.65	57.44	59.39	72.20
EER net ⁽¹⁾		3.28	3.08	2.94	2.72	2.66	2.95	2.82
Nominal thermal performances - Heating mode								
Heating capacity ⁽²⁾	kW	81.10	100.50	112.90	129.70	150.40	180.00	211.80
Total Power Input	kW	25.03	38.07	44.62	37.38	46.56	51.87	65.98
COP net ⁽²⁾		3.24	2.64	2.53	3.47	3.23	3.47	3.21
Seasonal efficiencies - Cooling mode								
Seasonal Energy Efficiency Ratio - SEER ⁽³⁾		4.48	4.43	4.20	4.20	4.06	4.20	3.86
Seasonal energy efficiency - η_{s,c} ⁽⁴⁾	%	176.20	174.20	165.00	165.00	159.40	165.00	151.40
Eurovent energy efficiency class - Part load operation		B	B	B	B	B	B	B
Seasonal efficiencies - Heating mode								
Seasonal Coefficient of Performance - SCOP ⁽⁵⁾		3.35	3.29	3.20	3.42	3.20	3.26	3.21
Seasonal energy efficiency - η_{s,h} ⁽⁶⁾	%	131.00	128.60	125.00	133.80	125.00	127.40	125.40
Eurovent energy efficiency class - Part load operation		B	B	B	B	B	B	B
Auxiliary heating								
Gas heating capacity - Standard / High	kW	60 / 120	60 / 120	60 / 120	120 / 180	120 / 180	180 / 240	180 / 240
Electric heater capacity - Standard / High		30 / 72	30 / 72	30 / 72	45 / 108	45 / 108	72 / 162	72 / 162
Electric pre-heater capacity - Standard / High		-	-	-	-	-	-	-
Hot water coil capacity Air inlet 20°C/Water		114 / 177	126 / 201	133 / 212	145 / 254	156 / 275	177 / 295	186 / 313
Ventilation data								
Minimum airflow rate	m ³ /h	12000	14800	15000	18000	21000	24000	24000
Nominal airflow rate		15000	18500	22000	26500	28000	33000	35000
Maximum airflow rate		23000	23000	23000	35000	35000	43000	43000
Acoustic data - Standard unit								
Outdoor sound power	dB(A)	86	90	93	86	88	86	90
Indoor blower outlet sound power		85,9	91,0	95,3	91,4	91,7	88,5	89,8
Electrical data								
Maximum power	kW	44,7	52,3	56,7	64,6	78,8	88,7	102,8
Maximum current	A	162,2	174,0	197,2	204,6	249,0	296,0	313,6
Starting current	A	75,5	86,9	98,9	106,2	133,0	152,0	169,6
Short circuit current	kA	10						
Refrigeration circuit								
Number of circuits		2						
Number of compressors		4						
Refrigerant load	kg	8,2 / 8,2	8,5 / 9	9 / 9	14,5 / 14,5	13,75/13,25	18 / 18	19,3 / 19,3

(1) **Cooling mode** : According to EN14511 nominal conditions - Outdoor temperature 35°C DB - Indoor temperature 27°C DB / 19°C WB

(2) **Heating mode** : According to EN14511 nominal conditions - Outdoor temperature 7°C DB / 6°C WB - Indoor temperature 20°C DB

(3) SEER in accordance with standard EN14825.

(4) Space cooling energy efficiency following Ecodesign regulation EU 2016/2281

(5) SCOP in accordance with standard EN 14825 (average climate conditions).

(6) Space heating energy efficiency following Ecodesign regulation EU 2016/2281.

FA^(A) C^(B) 100^(C) D^(D) N^(E) M^(F) 2^(G) M^(H)

- (A) **FA** = Flexair
- (B) **C** = Cooling only unit - **H** = Heat pump unit
- (C) Cooling capacity in kW
- (D) **S** = 1 circuit - **D** = 2 circuits - **T** = 3 circuits - **F** = 4 circuits
- (E) **H** = High heat - **S** = Standard heat - **N** = No heat
- (F) **M** = R410A - **H** = HFO - **N** = No refrigerant
- (G) Revision number
- (H) **M** = 400V/3/50Hz - **T** = 230V/1/50Hz



Water cooled version

Heat pump units

Flexair		085	100	120	150	170
Nominal thermal performances - Cooling mode						
Cooling capacity ⁽¹⁾	kW	90,2	114,4	125,9	159,8	175,2
Total Power Input	kW	19,36	24,66	28,88	31,83	39,11
EER net ⁽¹⁾		4,66	4,64	4,36	5,02	4,48
Nominal thermal performances - Heating mode						
Heating capacity ⁽²⁾	kW	111,9	131,5	153,2	191,6	226,9
Total Power Input	kW	23,61	29,35	34,74	38,55	51,45
COP net ⁽²⁾		4,74	4,48	4,41	4,97	4,41
Seasonal efficiencies - Cooling mode						
Seasonal Energy Efficiency Ratio - SEER ⁽³⁾		5,16	5,11	4,65	5,73	5,44
Seasonal energy efficiency - η_{s,c} ⁽⁴⁾	%	201	199	181	224	212
Eurovent energy efficiency class - Part load operation		-	-	-	-	-
Seasonal efficiencies - Heating mode						
Seasonal Coefficient of Performance - SCOP ⁽⁵⁾		3,53	3,69	3,12	4,21	4,27
Seasonal energy efficiency - η_{s,h} ⁽⁶⁾	%	136	143	120	163	166
Eurovent energy efficiency class - Part load operation		-	-	-	-	-
Auxiliary heating						
Gas heating capacity - Standard / High	kW	60 / 120	60 / 120	60 / 120	120 / 180	120 / 180
Electric heater capacity - Standard / High		30 / 72	30 / 72	30 / 72	45 / 108	45 / 108
Electric pre-heater capacity - Standard / High		-	-	-	-	-
Hot water coil capacity Air inlet 20°C/Water		114 / 177	126 / 201	133 / 212	145 / 254	156 / 275
Ventilation data						
Minimum airflow rate	m ³ /h	12000	14800	15000	18000	21000
Nominal airflow rate		15000	18500	22000	26500	28000
Maximum airflow rate		23000	23000	23000	35000	35000
Acoustic data - Standard unit						
Outdoor sound power	dB(A)	82,2	84,7	87,4	86,2	87,5
Indoor blower outlet sound power		87,8	89,4	93,3	92,7	95,5
Electrical data						
Maximum power	kW	39,5	45,1	56,6	62,7	79,8
Maximum current	A	211,0	262,0	279,4	252,8	278,5
Starting current	A	67,0	73,5	90,9	108,8	134,5
Short circuit current	kA	10				
Refrigeration circuit						
Number of circuits		2				
Number of compressors		2		3		4
Refrigerant load	kg	10,6 / 10,6	12,3 / 12,3	12,4 / 12,4	15,9 / 15,9	16 / 16

(1) **Cooling mode** : According to EN14511 nominal conditions - Outdoor temperature 35°C DB - Indoor temperature 27°C DB / 19°C WB

(2) **Heating mode** : According to EN14511 nominal conditions - Outdoor temperature 7°C DB / 6°C WB - Indoor temperature 20°C DB

(3) SEER in accordance with standard EN14825.

(4) Space cooling energy efficiency following Ecodesign regulation EU 2016/2281

(5) SCOP in accordance with standard EN 14825 (average climate conditions).

(6) Space heating energy efficiency following Ecodesign regulation EU 2016/2281.



Air cooled version

Flexair		090	100	120	150	170	200	230
A	mm	2245	2245	2245	2245	2245	2260	2260
B		3315	3315	3315	4360	4360	5166	5166
C		1750	1750	1750	1885	1885	2235	2235
D		360	360	360	456	456	620	620
Weight of standard units								
Basic unit	kg	966	1055	1054	1454	1550	2027	2143



Water cooled version

Flexair		085	100	120	150	170
A	mm	2290	2290	2290	2290	2290
B		3348	3348	3348	4385	4385
C		1510	1510	1510	1830	1830
D		415	415	415	415	415
Weight of standard units						
Basic unit	kg	790	874	955	1237	1300

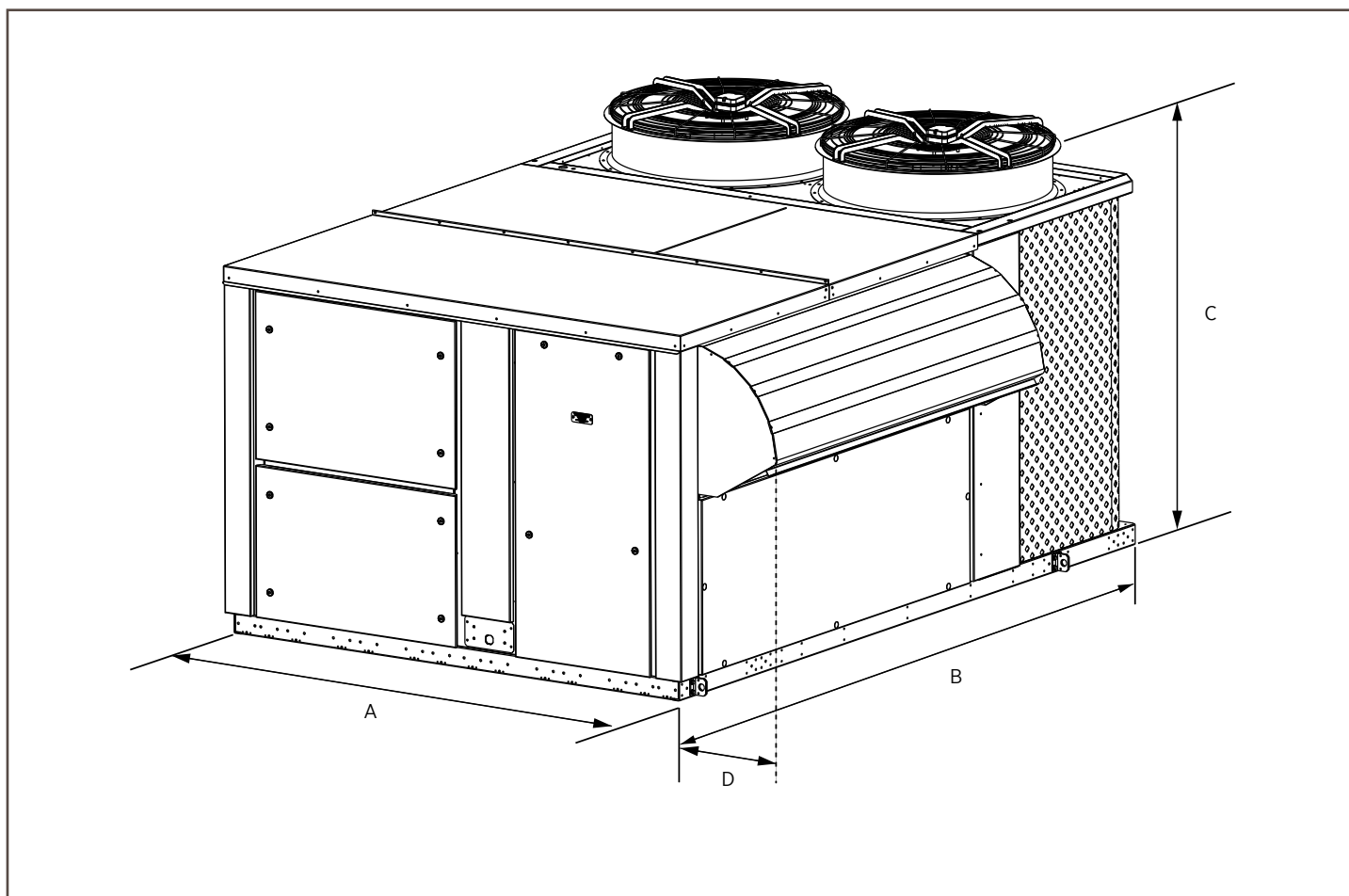

CHILLERS & HEAT PUMPS



eComfort MC *Inverter*

53



eComfort *Inverter*

63



eProcess *Inverter*

81



WHAT IS A CHILLER & HEAT PUMP?

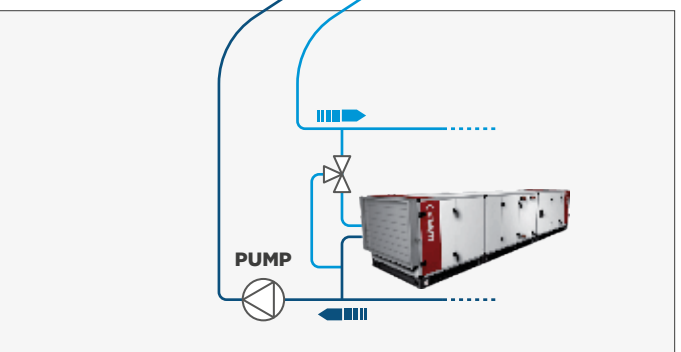
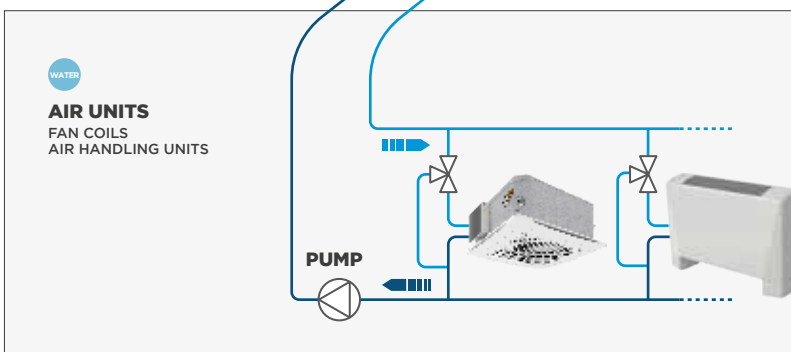
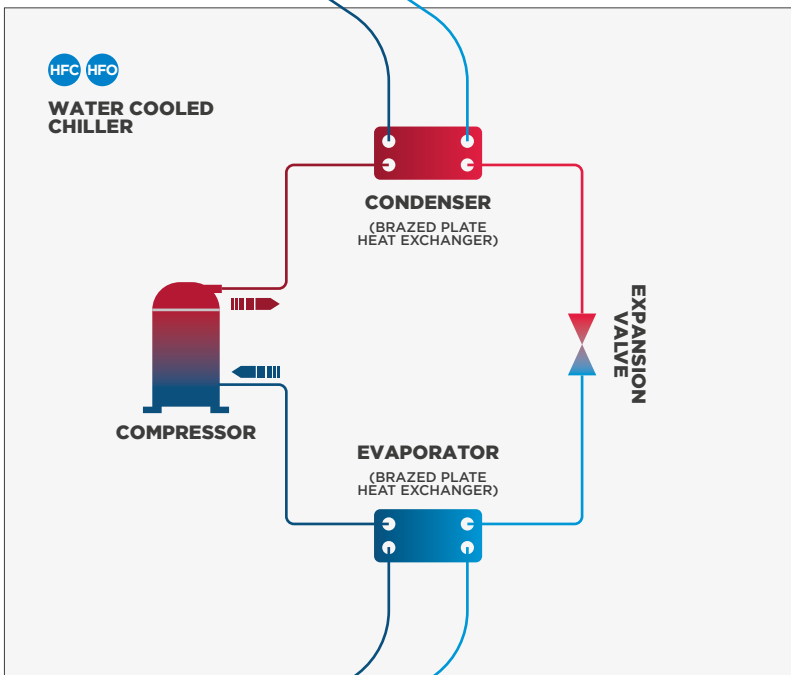
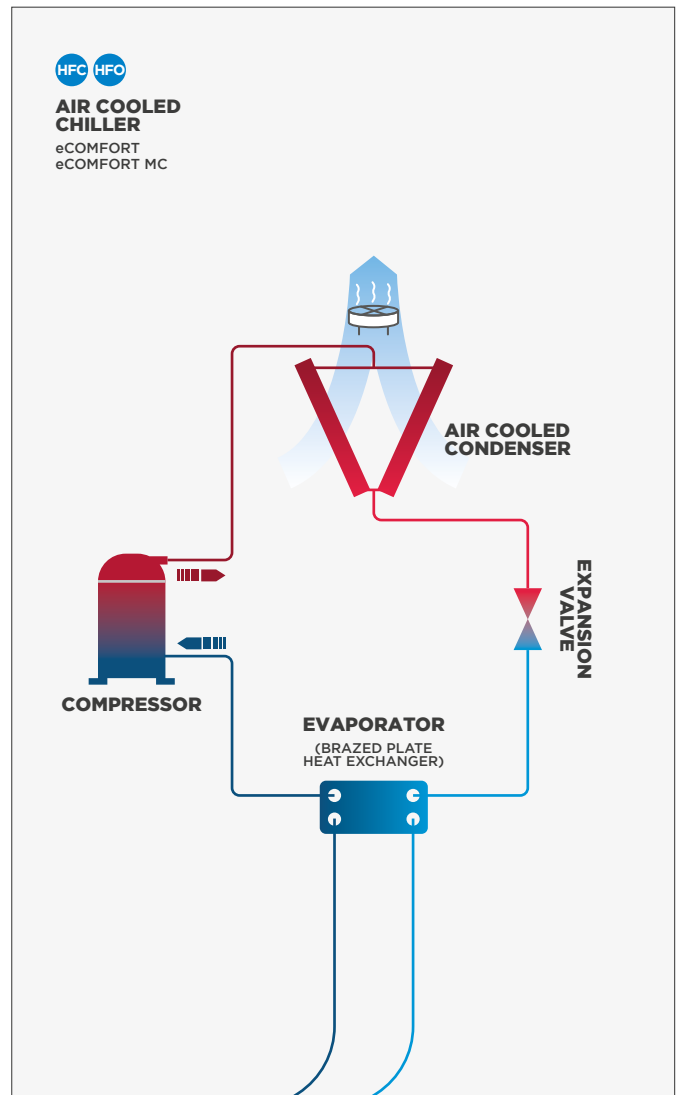
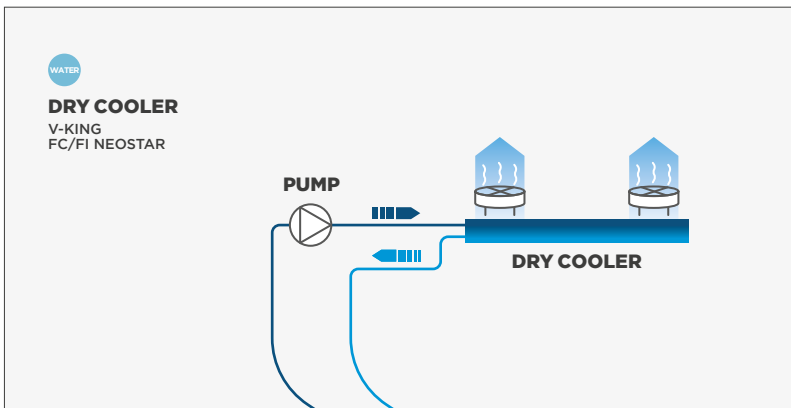

A chiller/heat pump is an HVAC unit designed to cool or heat water for comfort or process applications. It can be installed on many different types of buildings, such as shopping malls, commercial centres, office buildings, hotels, hospitals, data centres, industrial workshops and industrial process. They provide cooling or heating capacity to other air units, such as fan coils and air handling units, and, dependent on the model, the heat rejection may be performed by a condenser or a dry cooler, making it a flexible solution for different building designs. Our wide range of chillers and heat pumps offers multiple choices of refrigerant and product design to better support your project, whether you are looking for an indoor or outdoor installation, with built-in or remote condensers or dry coolers.





CHILLERS & HEAT PUMPS



 AIR / WATER COOLED

 	 eComfort MC 		 220 - 700 kW  220 - 450 kW	     	
					
 	 eProcess 		 310 - 1550 kW	     	
			 330 - 1950 kW	     	
				 280 - 1220 kW	     
				 200 - 1450 kW	     

-  Air/Air
-  Water/Air
-  Water/Water

-  Cooling capacity
-  Heating capacity
-  Airflow rate

-  Cafés Restaurants
-  Non food retail
-  Food retail

-  Shopping malls
-  Storage & Logistics
-  Industry

■ Standard equipment ● Option

Additional configurations/options are available on request, please contact your sales representative.

REFRIGERANT CIRCUIT	R32
	R1234ze
	R513A
	R134A
	Winter cooling operation
	Low leaving water temperature down to -10°C
COMPRESSOR	Multiscroll
	Screw
	Inverter
	Low noise
	Super low noise
EXPANSION VALVE	Thermostatic
	Electronic
FAN	Axial fan
	Variable air flow control of condensation : HP floating
	EC fan
	Fan static pressure
AIR COIL	Standard copper tube/aluminium fin ⁽¹⁾
	Micro channel heat exchanger ⁽²⁾
	Heavy anti-corrosion coil treatment
	Coils protection guards
HEAT EXCHANGER	Brazed plate heat exchanger
	Shell and Tube
ELECTRICAL	Main disconnect switch
	Phase reversal protection
	Antifreeze protection
	Softstarter
	Water tank modulating auxiliary electrical heater (heat pump)
	Power factor correction
	Energy meter
HYDRAULIC MODULE	Paddle flow switch
	Electronic flow switch
	Water filter
	Flange connection
	Water tank
	Low-pressure single pump
	Low-pressure twin pump
	High-pressure single pump
	High-pressure twin pump
	eDrive high-pressure single pump (variable primary flow)
	eDrive high-pressure twin pump (variable primary flow)
	By-pass valve for Delta P control (eDrive)

eComfort R32/35-210kW	eComfort MC R32/220-400kW	eComfort MC R32/400-700kW	eProcess
■	■	■	-
-	-	-	■
-	-	-	■
●	●	●	●
●	●	●	●
■	■	■	■
-	-	-	■
●	●	-	●
■	■	■	●
■	■	■	●
●	●	●	●
●	●	●	●
■	■	■	-
-	-	-	■
■	■	■	■
●	●	●	●
●	●	●	●
●	●	●	●
●	●	●	●
●	●	-	-
●	●	●	-
●	●	●	●
■	■	■	●
-	-	-	●
●	●	●	●
●	●	●	●
●	●	●	-
●	●	●	●
●	●	●	●
●	●	●	●
●	●	●	●
●	●	●	●
●	●	●	-

(1) Reversible heat pump units.

(2) Cooling only units.

eComfort MC

New!

Air cooled chillers / Heat pumps



R32



AIR COOLED

 220 - 700 kW

 220 - 450 kW

LENNOX participates in the ECP programme for LCP-HP. Check ongoing validity of certificate : www.eurovent-certification.com

- # **Fast and easy installation and commissioning** thanks to the integration of a complete hydraulic module with buffer tank and immersed heating rods.
- # **Total system modulation** granted by EC motor fans and inverter technology on compressors and pumps.
- # **Excellent seasonal energy efficiencies** (SEER) that exceed the European EcoDesign 2021 requirements. And SCOP that exceed the European EcoDesign 2017.
- # **Precise water temperature control** in cooling and heating mode thanks to highly efficient components.

CONTROL

- # eClimatic electronic controller and intelligent control parameters optimising part-load efficiency.
- # Integrated communication solutions offering flexibility (master/slave, Modbus, BACnet).
- # DC Advanced display, equipped with a graphic screen providing access to the main user parameters, with two optional displays:
 - Remote Display
 - Service Display

eCLIMATIC



DC Advanced



eDRIVE

Variable speed drive pump option, which modulates the water flow through the plate heat exchanger and reduces energy costs:

- # Saves energy consumption especially at part-load conditions and during off period, reaching up to 75% reduction of the pump consumption.
- # Savings on the initial system cost, due to fewer pumps and piping connections than primary-secondary systems.
- # Flexibility and accuracy of the pump operation control: smooth start and stop, gradual change of speed, accuracy and stability of control.
- # Reduction of the repeated stress on the pump and piping resulting in longer equipment lifetime.
- # Elimination of the start-up current thanks to variable frequency drive that controls a gradual pump motor supply.



REMOTE MONITORING

- # Connectivity through **LennoxHydrocontrol**, a user-friendly interface for local supervision of the entire hydraulic system.
- # Connectivity through **LennoxCloud** (LENNOX WEB PORTAL for Multi sites / units).
- # BMS through: **e-savvy**

ACOUSTIC COMFORT

Three different noise level configurations available:

- # **Quiet operation** (standard), achieved with compact design, silent compressors and pumps, and with high-performance propeller fans, all installed in a closed box.
- # **Low noise level option:** High performance acoustic compressor jacket can halve the noise produced by the unit.
- # **Active Acoustic Attenuation System** with variable fan speed allows progressive adaptation of the unit to the building load while respecting the noise level constraints and the operating limits (as an option).

CASING & DESIGN

- # Casing made of white painted galvanised steel.
- # Compact design, granted by the V-shaped coils.
- # All thermodynamic and hydraulic components installed below the coils.



THERMODYNAMIC SYSTEM

- # Multi-scroll compressors, mounted in tandem or trio, to provide the best seasonal efficiencies.
- # Aluminium microchannel condenser coil on cooling only units.
- # Large surface exchangers built with copper tubing and aluminium fins on heat-pump units.
- # High performance propeller fans with profiled blades to improve efficiency and reduce noise level (EC version available as an option).
- # Thermally insulated and frost-protected water heat exchangers made from stainless steel plates with copper brazing.
- # One or two independent circuits, each equipped with electronic expansion valves.
- # Desuperheater (as an option): additional plate heat exchanger on each circuit to recover the rejected heat and provide free hot water for sanitary or industrial purposes.



G^(A) A^(B) C^(C) 220^(D) D^(E) P^(F) 2^(G) M^(H)

- (A) **G** = eComfort
- (B) **A** = Standard Air Cooled unit - **B** = Advanced air cooled unit
- (C) **C** = Cooling only unit - **H** = Heat pump unit
- (D) **220** = Approximate power in kW
- (E) **D** = Dual circuit
- (F) **P** = Refrigerant R32
- (G) **2** = Revision number
- (H) **M** = 400V/3/50Hz



Air cooled version - Standard version

Cooling only units

eCOMFORT - GAC		F BOX			G BOX				
		220D	250D	300D	330D	370D	400D		
Nominal thermal performances - Cooling mode									
Cooling capacity ⁽¹⁾		kW	213.8	250	292.5	326.8	362.2	405.6	
Total absorbed power ⁽¹⁾		kW	67.8	79	97.9	105.6	118.7	135.2	
EER ⁽¹⁾			3.15	3.16	2.99	3.09	3.05	3	
Comfort Application	Standard Fans	Seasonal Energy Efficiency Ratio ⁽²⁾ SEER		5.25	5.05	4.85	4.93	4.95	5.1
		Seasonal energy efficiency ⁽³⁾ η_{s,c}	%	207	199	191	194	195	201
Process Application	Standard Fans	Seasonal Energy Performance Ratio ⁽⁴⁾ SEPR - High temperature (7°C)		6.75	6.73	6.44	6.7	6.66	6.37
Nominal thermal performances - Heating mode									
Heating capacity ⁽¹⁾		kW	-	-	-	-	-	-	
Total absorbed power ⁽¹⁾		kW	-	-	-	-	-	-	
COP ⁽¹⁾			-	-	-	-	-	-	
Eurovent energy class ⁽¹⁾ - Full load operation			-	-	-	-	-	-	
Comfort Application	Standard Fans	Seasonal Coefficient of Performance ⁽⁶⁾ SCOP		-	-	-	-	-	
		Seasonal energy efficiency ⁽⁷⁾ η_{s,h}	%	-	-	-	-	-	
		Seasonal efficiency class ⁽⁸⁾		-	-	-	-	-	
Acoustic data									
Global sound power level - Standard unit		dB(A)	90.6	92.3	92.3	92.1	92.1	94.6	
Electrical data									
Maximum power		kW	97.8	110.2	131	150.2	165.9	183.5	
Maximum current		A	329.1	331.2	397.4	428.3	454.6	612.6	
Starting current		A	164.4	180.6	215.6	246.4	272.6	302.7	
Short circuit current		kA	50	50	50	50	50	50	
Refrigeration circuit									
Number of circuits			2	2	2	2	2	2	
Number of compressors			2 / 2	2 / 2	2 / 2	2 / 3	2 / 3	2 / 3	
Total refrigerant load - R32		kg	20	22	24	31	31,5	34	
Evaporator		Brazen plate heat exchanger							
Nominal water flow rate		m ³ /h	36.88	43.12	50.45	56.36	62.48	69.96	
Nominal pressure drop		kPa	29.97	30.44	39.31	48.63	54.77	65.93	
Hydraulic connection									
Type		Victaulic							
Diameter			4"	4"	4"	4"	4"	5"	

(1) EUROVENT certified data, in accordance with standard EN 14511.

Cooling mode: Evaporator water temperature = 12/7°C | Outdoor air temperature = 35°C / **Heating mode:** Condenser water temperature = 40/45°C | Outdoor air temperature = 7°C
 (2) SEER in accordance with standard EN 14825. | (3) Following ecodesign regulation EU 2016/2281 on space cooling, normalized leaving water temperature at 7°C, in accordance with standard EN 14825. | (4) Following ecodesign regulation EU 2016/2281 on process cooling units, normalized leaving water temperature at 7°C, in accordance with standard EN 14825. | (5) Following ecodesign regulation EU 2015/1095 on process cooling chillers, normalized leaving water temperature at -8°C, in accordance with standard EN 14825. | (6) SCOP in accordance with standard EN 14825. Heating mode performance is defined for average climate conditions. | (7) Following ecodesign regulation EU 813/2013 on space heaters, normalized leaving water temperature at 7°C, in accordance with standard EN 14825, average climate conditions. | (8) Following energy labelling regulation EU 811/2013 on space heaters.

G^(A) A^(B) C^(C) 220^(D) D^(E) P^(F) 2^(G) M^(H)

- (A) **G** = eComfort
 (B) **A** = Standard Air Cooled unit - **B** = Advanced air cooled unit
 (C) **C** = Cooling only unit - **H** = Heat pump unit
 (D) **220** = Approximate power in kW
 (E) **D** = Dual circuit
 (F) **P** = Refrigerant R32
 (G) **2** = Revision number
 (H) **M** = 400V/3/50Hz



Air cooled version - Standard version

Cooling only units

eCOMFORT - GAC		H BOX			I BOX					
		450D	480D	500D	550D	600D	660D	700D		
Nominal thermal performances - Cooling mode										
Cooling capacity ⁽¹⁾		kW	438	479	531	574	616	659	695	
Total absorbed power ⁽¹⁾		kW	138,9	155,2	171,7	181,5	197,8	214,8	231,4	
EER ⁽¹⁾			3,15	3,08	3,09	3,16	3,11	3,07	3,00	
Comfort Application	Standard Fans	Seasonal Energy Efficiency Ratio ⁽²⁾ SEER		5,36	5,24	5,20	5,19	5,10	5,13	5,16
		Seasonal energy efficiency ⁽³⁾ η_{s,c}		%	211	207	205	204	201	202
Process Application	Standard Fans	Seasonal Energy Performance Ratio ⁽⁴⁾ SEPR - High temperature (7°C)		6,90	6,66	6,61	6,70	6,67	6,64	6,47
Nominal thermal performances - Heating mode										
Heating capacity ⁽¹⁾		kW	-	-	-	-	-	-	-	
Total absorbed power ⁽¹⁾		kW	-	-	-	-	-	-	-	
COP ⁽¹⁾			-	-	-	-	-	-	-	
Eurovent energy class ⁽¹⁾ - Full load operation			-	-	-	-	-	-	-	
Comfort Application	Standard Fans	Seasonal Coefficient of Performance ⁽⁶⁾ SCOP		-	-	-	-	-	-	
		Seasonal energy efficiency ⁽⁷⁾ η_{s,h}		%	-	-	-	-	-	-
		Seasonal efficiency class ⁽⁸⁾			-	-	-	-	-	-
Acoustic data										
Global sound power level - Standard unit		dB(A)	91,9	94,5	96,2	96,1	97,6	98,0	98,4	
Electrical data										
Maximum power		kW	189,0	210,7	232,3	247,6	271,3	288,9	306,5	
Maximum current		A	309,4	345,6	381,9	408,7	448,1	478,2	508,3	
Starting current		A	491,3	655,5	691,7	718,5	757,9	788,0	818,1	
Short circuit current		kA	-							
Refrigeration circuit										
Number of circuits			2	2	2	2	2	2	2	
Number of compressors			3 / 3	3 / 3	3 / 3	3 / 3	3 / 3	3 / 3	3 / 3	
Total refrigerant load - R32		kg	43	44	47	56	60	61	61,5	
Evaporator		Braze plate heat exchanger								
Nominal water flow rate		m ³ /h	75,51	82,56	91,62	98,96	106,20	113,75	120,09	
Nominal pressure drop		kPa	38,11	45,20	46,20	53,43	61,04	60,34	65,64	
Hydraulic connection										
Type		Victaulic								
Diameter		5"								

(1) EUROVENT certified data, in accordance with standard EN 14511.

Cooling mode: Evaporator water temperature = 12/7°C | Outdoor air temperature = 35°C / **Heating mode:** Condenser water temperature = 40/45°C | Outdoor air temperature = 7°C

(2) SEER in accordance with standard EN 14825. | (3) Following ecodesign regulation EU 2016/2281 on space cooling, normalized leaving water temperature at 7°C, in accordance with standard EN 14825. | (4) Following ecodesign regulation EU 2016/2281 on process cooling units, normalized leaving water temperature at 7°C, in accordance with standard EN 14825. |

(5) Following ecodesign regulation EU 2015/1095 on process cooling chillers, normalized leaving water temperature at -8°C, in accordance with standard EN 14825. |

(6) SCOP in accordance with standard EN 14825. Heating mode performance is defined for average climate conditions. | (7) Following ecodesign regulation EU 813/2013 on space heaters, normalized leaving water temperature at 7°C, in accordance with standard EN 14825, average climate conditions. | (8) Following energy labelling regulation EU 811/2013 on space heaters.

G_(A) B_(B) C_(C) 220_(D) D_(E) P_(F) 2_(G) M_(H)

- (A) **G** = eComfort
- (B) **A** = Standard Air Cooled unit - **B** = Advanced air cooled unit
- (C) **C** = Cooling only unit - **H** = Heat pump unit
- (D) **220** = Approximate power in kW
- (E) **D** = Dual circuit
- (F) **P** = Refrigerant R32
- (G) **2** = Revision number
- (H) **M** = 400V/3/50Hz



Air cooled version - Advanced version Inverter

Cooling only units

eCOMFORT - GBC		F BOX		G BOX			
		220D	250D	300D	330D		
Nominal thermal performances - Cooling mode							
Cooling capacity ⁽¹⁾		kW	240,1	262,4	297,2	332,5	
Total absorbed power ⁽¹⁾		kW	76,1	85,7	93,2	106,3	
EER ⁽¹⁾			3,2	3,1	3,2	3,1	
Eurovent energy class ⁽¹⁾ - Full load operation			5.25	5.13	5.15	5.1	
Comfort Application	AC Fans	Seasonal Energy Efficiency Ratio ⁽²⁾ SEER		207	202	203	201
		Seasonal energy efficiency ⁽³⁾ η_{s,c}	%	3.84	3.9	3.69	3.75
Process Application		Seasonal Energy Performance Ratio ⁽⁴⁾ SEPR - High temperature (7°C)		6.33	6.28	6.45	6.45
Nominal thermal performances - Heating mode							
Heating capacity ⁽¹⁾		kW	338,7	340,4	385,3	430	
Total absorbed power ⁽¹⁾		kW	112,5	112,7	127,5	142,8	
COP ⁽¹⁾			3,01	3,02	3,02	3,01	
Eurovent energy class ⁽¹⁾ - Full load operation			B	B	B	B	
Comfort Application	AC Fans	Seasonal Coefficient of Performance ⁽⁶⁾ SCOP		3,68	3,85	3,83	3,65
		Seasonal energy efficiency ⁽⁷⁾ η_{s,h}	%	144	151	150	143
Seasonal efficiency class ⁽⁸⁾			A+	A+	A+	A+	
Acoustic data							
Global sound power level - Standard unit		dB(A)	92,9	92,9	92,7	92,7	
Electrical data							
Maximum power		kW	108.8	119.3	133.5	149.2	
Maximum current		A	420	437.5	460.2	486.4	
Starting current		A	178.2	195.6	218.3	244.6	
Short circuit current		kA	50,0	50,0	50,0	50,0	
Refrigeration circuit							
Number of circuits			2	2	2	2	
Number of compressors			2+2	2+2	2+2	2+3	
Total refrigerant load - R32		kg	20,0	22,0	28,0	30,0	
Evaporator							
Nominal water flow rate		m ³ /h	41,4	45,3	51,3	57,4	
Nominal pressure drop		kPa	28,2	31,9	40,5	46,4	
Hydraulic connection							
Type		Victaulic or Welded					
Diameter			4"	4"	4"	4"	

⁽¹⁾ EUROVENT certified data, in accordance with standard EN 14511.

Cooling mode: Evaporator water temperature = 12/7°C | Outdoor air temperature = 35°C / **Heating mode:** Condenser water temperature = 40/45°C | Outdoor air temperature = 7°C

⁽²⁾ SEER in accordance with standard EN 14825. | ⁽³⁾ Following ecodesign regulation EU 2016/2281 on space cooling, normalized leaving water temperature at 7°C, in accordance with standard EN 14825. | ⁽⁴⁾ Following ecodesign regulation EU 2016/2281 on process cooling units, normalized leaving water temperature at 7°C, in accordance with standard EN 14825. |

⁽⁵⁾ Following ecodesign regulation EU 2015/1095 on process cooling chillers, normalized leaving water temperature at -8°C, in accordance with standard EN 14825. |

⁽⁶⁾ SCOP in accordance with standard EN 14825. Heating mode performance is defined for average climate conditions. | ⁽⁷⁾ Following ecodesign regulation EU 813/2013 on space

G^(A) A^(B) H^(C) 220^(D) D^(E) P^(F) 2^(G) M^(H)

- (A) **G** = eComfort
 (B) **A** = Standard Air Cooled unit - **B** = Advanced air cooled unit
 (C) **C** = Cooling only unit - **H** = Heat pump unit
 (D) **220** = Approximate power in kW
 (E) **D** = Dual circuit
 (F) **P** = Refrigerant R32
 (G) **2** = Revision number
 (H) **M** = 400V/3/50Hz



Air cooled version - Standard version

Heat pumps units

eCOMFORT - GAH		F BOX		G BOX			H BOX				
		220D	250D	280D	300D	350D	370D	400D	450D		
Nominal thermal performances - Cooling mode											
Cooling capacity ⁽¹⁾		kW	211,9	248,9	274,2	303,7	342,2	366	404,7	441	
Total absorbed power ⁽¹⁾		kW	69,7	81,7	86,3	99,3	112,6	117	130,1	143	
EER ⁽¹⁾			3,04	3,05	3,18	3,06	3,04	3,13	3,11	3,08	
Comfort Application	EC Fans	Seasonal Energy Efficiency Ratio ⁽²⁾ SEER		199	193	195	196	195	211	210	204
		Seasonal energy efficiency ⁽³⁾ η_{s,c}	%	3,99	4,09	4,11	4,02	4,05	4,07	4,08	4,08
Process Application	EC Fans	Seasonal Energy Performance Ratio ⁽⁴⁾ SEPR - High temperature (7°C)		6,56	6,68	6,59	6,77	6,62	7	6,85	6,68
Nominal thermal performances - Heating mode											
Heating capacity ⁽¹⁾		kW	210,8	242,6	270,3	299,3	341,8	350,1	392,5	434,3	
Total absorbed power ⁽¹⁾		kW	68,6	79,2	85,6	97,2	112,3	112,7	127,2	142	
COP ⁽¹⁾			3,07	3,06	3,16	3,08	3,04	3,11	3,08	3,06	
Eurovent energy class ⁽¹⁾ - Full load operation			B	B	B	B	B	A	B	B	
Comfort Application	EC Fans	Seasonal Coefficient of Performance ⁽⁶⁾ SCOP		3,55	3,58	3,65	3,6	3,68	3,85	3,83	3,65
		Seasonal energy efficiency ⁽⁷⁾ η_{s,h}	%	139	140	143	141	144	151	150	143
		Seasonal efficiency class ⁽⁸⁾			A+	A+	A+	A+	A+	A+	A+
Acoustic data											
Global sound power level - Standard unit		dB(A)	91,8	92,3	91,5	92,0	93,7	91,8	93,5	94,7	
Electrical data											
Maximum power		kW	96,00	108,4	118,5	133	152,7	157,7	177,4	197,1	
Maximum current		A	325,1	327,2	375,8	367,4	431,1	407,6	471,2	503,7	
Starting current		A	160,4	176,6	193,9	216,8	249,2	256,9	289,3	321,8	
Short circuit current		kA	50								
Refrigeration circuit											
Number of circuits			2	2	2	2	2	2	2	2	
Number of compressors			2+2	2+2	2+2	2+3	2+3	3+3	3+3	3+3	
Total refrigerant load - R32		kg	45	48	60	60	63	74	79,5	85	
Evaporator											
Nominal water flow rate		m ³ /h	36,56	42,93	47,3	52,38	59,03	63,12	69,81	76,07	
Nominal pressure drop		kPa	29,47	28,83	34,72	42,25	49,07	29,69	32,80	38,65	
Hydraulic connection											
Type			Victaulic								
Diameter			4"	4"	4"	4"	4"	5"	5"	5"	

(1) EUROVENT certified data, in accordance with standard EN 14511.

Cooling mode: Evaporator water temperature = 12/7°C | Outdoor air temperature = 35°C / **Heating mode:** Condenser water temperature = 40/45°C | Outdoor air temperature = 7°C
 (2) SEER in accordance with standard EN 14825. | (3) Following ecodesign regulation EU 2016/2281 on space cooling, normalized leaving water temperature at 7°C, in accordance with standard EN 14825. | (4) Following ecodesign regulation EU 2016/2281 on process cooling units, normalized leaving water temperature at 7°C, in accordance with standard EN 14825. | (5) Following ecodesign regulation EU 2015/1095 on process cooling chillers, normalized leaving water temperature at -8°C, in accordance with standard EN 14825. | (6) SCOP in accordance with standard EN 14825. Heating mode performance is defined for average climate conditions. | (7) Following ecodesign regulation EU 813/2013 on space heaters, normalized leaving water temperature at 7°C, in accordance with standard EN 14825, average climate conditions. | (8) Following energy labelling regulation EU 811/2013 on space heaters.

G_(A) A_(B) H_(C) 220_(D) D_(E) P_(F) 2_(G) M_(H)

- (A) **G** = eComfort
- (B) **A** = Standard Air Cooled unit - **B** = Advanced air cooled unit
- (C) **C** = Cooling only unit - **H** = Heat pump unit
- (D) **220** = Approximate power in kW
- (E) **D** = Dual circuit
- (F) **P** = Refrigerant R32
- (G) **2** = Revision number
- (H) **M** = 400V/3/50Hz



Air cooled version - Fixed speed AC Fan (SFAC)

Heat pumps units

eCOMFORT - GAH		F BOX		G BOX			H BOX				
		220D	250D	280D	300D	350D	370D	400D	450D		
Nominal thermal performances - Cooling mode											
Cooling capacity ⁽¹⁾		kW	213,5	247,8	275,7	302,4	341,8	364,2	403,7	440,9	
Total absorbed power ⁽¹⁾		kW	70,2	82,3	86,6	100,4	113,4	118,7	131,4	144	
EER ⁽¹⁾			3,04	3,01	3,18	3,01	3,02	3,07	3,07	3,06	
Eurovent energy class ⁽¹⁾ - Full load operation			5,05	4,9	4,95	4,98	4,95	5,35	5,33	5,18	
Comfort Application	AC Fans	Seasonal Energy Efficiency Ratio ⁽²⁾ SEER		199	193	195	196	195	211	210	204
		Seasonal energy efficiency ⁽³⁾ η_{s,c}		%	6,56	6,68	6,59	6,77	6,62	7	6,85
Process Application	AC Fans	Seasonal Energy Performance Ratio ⁽⁴⁾ SEPR - High temperature (7°C)		3,99	4,09	4,11	4,02	4,05	4,07	4,08	4,08
Nominal thermal performances - Heating mode											
Heating capacity ⁽¹⁾		kW	212,7	240,9	268,6	296,1	338,7	340,4	385,3	430	
Total absorbed power ⁽¹⁾		kW	70,8	79,1	86,4	97,6	112,5	112,7	127,5	142,8	
COP ⁽¹⁾			3	3,04	3,11	3,03	3,01	3,02	3,02	3,01	
Eurovent energy class ⁽¹⁾ - Full load operation			B	B	B	B	B	B	B	B	
Comfort Application	AC Fans	Seasonal Coefficient of Performance ⁽⁶⁾ SCOP		3,55	3,58	3,65	3,6	3,68	3,85	3,83	3,65
		Seasonal energy efficiency ⁽⁷⁾ η_{s,h}		%	139	140	143	141	144	151	150
		Seasonal efficiency class ⁽⁸⁾		A+	A+	A+	A+	A+	A+	A+	A+
Acoustic data											
Global sound power level - Standard unit		dB(A)	90,7	91,3	90,7	91,3	92,7	91,4	92,6	93,6	
Electrical data											
Maximum power		kW	96	108,4	118,5	133	152,7	157,7	177,4	197,1	
Maximum current		A	328,3	330,4	380	371,6	435,9	412,8	477	510,1	
Starting current		A	163,6	179,8	198,1	221	254	262,1	295,1	328,2	
Short circuit current		kA	50								
Refrigeration circuit											
Number of circuits			2	2	2	2	2	2	2	2	
Number of compressors			2+2	2+2	2+2	2+3	2+3	3+3	3+3	3+3	
Total refrigerant load - R32		kg	45	46	60	60	63	74	79,5	85	
Evaporator											
Nominal water flow rate		m ³ /h	36,82	42,74	47,56	52,16	58,95	62,82	69,63	76,06	
Nominal pressure drop		kPa	29,87	28,59	35,09	41,90	48,94	29,42	32,64	38,64	
Hydraulic connection											
Type		Victaulic									
Diameter			4"	4"	4"	4"	4"	5"	5"	5"	

(1) EUROVENT certified data, in accordance with standard EN 14511.

Cooling mode: Evaporator water temperature = 12/7°C | Outdoor air temperature = 35°C / **Heating mode:** Condenser water temperature = 40/45°C | Outdoor air temperature = 7°C

(2) SEER in accordance with standard EN 14825. | (3) Following ecodesign regulation EU 2016/2281 on space cooling, normalized leaving water temperature at 7°C, in accordance with standard EN 14825. | (4) Following ecodesign regulation EU 2016/2281 on process cooling units, normalized leaving water temperature at 7°C, in accordance with standard EN 14825. |

(5) Following ecodesign regulation EU 2015/1095 on process cooling chillers, normalized leaving water temperature at -8°C, in accordance with standard EN 14825. |

(6) SCOP in accordance with standard EN 14825. Heating mode performance is defined for average climate conditions. | (7) Following ecodesign regulation EU 813/2013 on space



Air cooled version

Cooling only units

eCOMFORT - GAC		220D	250D	300D	330D	370D	400D
A	mm		2772			4044	
B			2264			2264	
C			2421			2421	
Weight of standard units							
Basic unit	kg	1588	1690	1728	2243	2263	2334



Air cooled version

Cooling only units

eCOMFORT - GAC		450D	480D	500D	550D	600D	660D	700D
A	mm		2264			2264		
B			5326			6588		
C			2421			2421		
Weight of standard units								
Basic unit	kg	2884	2934	3034	3584	3654	3774	3884



Air cooled version - Advanced version

Cooling only units

eCOMFORT - GBC		220D	250D	300D	330D
A	mm		2770		4044
B			2264		2264
C			2421		2421
Weight of standard units					
Basic unit	kg	1588	1690	1728	2243



Air cooled version

Heat pumps units

eCOMFORT - GAH		220D	250D	280D	300D	350D	370D	400D	450D
A	mm	2250			2250			2250	
B		2704			3976			5248	
C		2401			2401			2401	
Weight of standard units									
Basic unit	kg	1883	2004	2474	2614	2695	3203	3291	3338

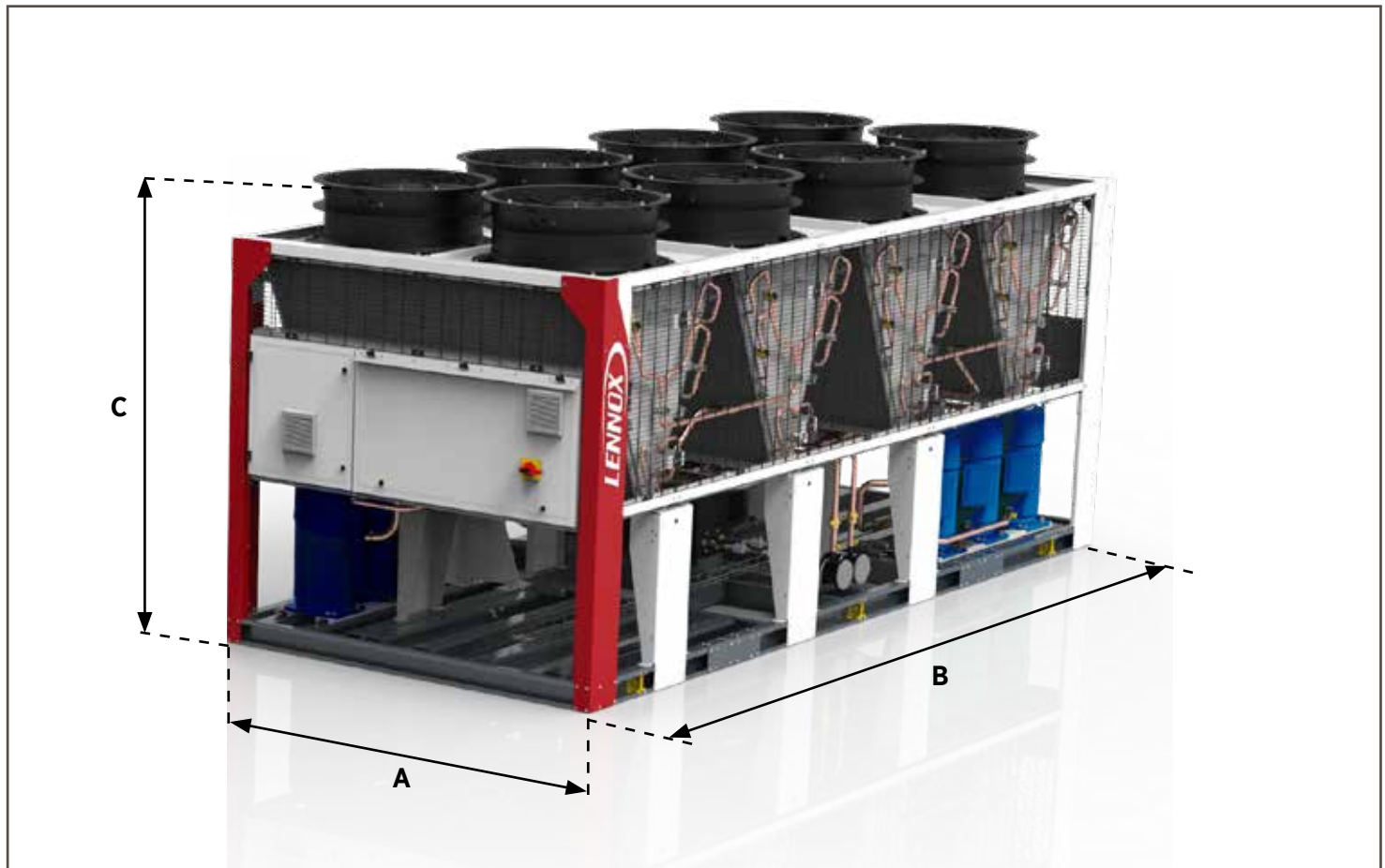

eComfort & eComfort Advanced

Air cooled chillers / Heat pumps



R32



R32



R32

AIR COOLED



35 - 210 kW
35 - 210 kW



R32

ADVANCED AIR COOLED



40 - 210 kW
40 - 210 kW



- # **Fast and easy installation and commissioning** thanks to the integration of a complete hydraulic module with buffer tank and immersed heating rods.
- # Compact and discreet design **for perfect architectural integration**.
- # **Excellent SEPR seasonal energy efficiencies**, which exceed the European EcoDesign 2021 requirements regarding high-temperature process cooling.
- # **Precise water temperature control** in cooling and heating modes thanks to highly efficient components.



THERMODYNAMIC SYSTEM

- # Extended operating map to match most market requirements
- # New heat exchanger and latest generation components to provide high efficiency and the best Total Cost of Ownership (TCO) of the market
- # R32 refrigerant (GWP = 675) enabling a decrease of the refrigerant load (-30%) and of the unit's carbon footprint (-75% TeqCO₂)
- # Desuperheater (as an option): additional plate heat exchanger on each circuit to recover the rejected heat and provide free hot water for sanitary or industrial purposes

INVERTER COMPRESSOR

The cooling demand is precisely adapted to the needs :

- # Optimized design for compact footprint, including water tank (as an option)
- # The control of the outlet water temperature is perfect.
- # Buffer tank requirements in case of low water volume or fast variable heat load are reduced.



R32 is an obvious choice to replace R410A. It already makes up 50% of its composition, and it has a number of other key advantages:

- # low GWP: 675
- # low cost
- # pure substance
- # many providers due to no patent



EC STANDARD FANS

Intelligent noise attenuation management thanks to:

- # Acoustic compressor jacket
- # High efficiency EC fans
- # A further increase in energy savings through improved seasonal efficiencies (floating HP).
- # Year-round operation down to -20 °C outdoor temperature in cooling mode.
- # Year-round operation up to 30 °C outdoor temperature in heating mode (heat pump).
- # Intelligent noise attenuation management, programmable night and day, combined with acoustic covers.

TOTAL MODULATION

The eCOMFORT range benefits from the **latest technologies** to achieve **very high seasonal efficiencies**

- # Refrigerant : thanks to a very high efficiency variable speed compressor with permanent magnet motor,
- # Air : with high-efficiency EC fans with "Owlet" type blades and high performance integrated diffusers to improve airflow efficiency,
- # Water : thanks to the variable speed inverter of the water pump.
- # The integrated control management (ModBus / BACnet / Ethernet TCP / IP communication interface / Lennox Cloud as an option) offers a turnkey control solution.



eDRIVE

Variable speed drive pump option, which modulates the water flow through the plate heat exchanger and reduces energy costs:

- # Saves energy consumption especially at part-load conditions and during off period, reaching up to 75% reduction of the pump consumption.
- # Savings on the initial system cost, due to fewer pumps and piping connections than primary-secondary systems.
- # Flexibility and accuracy of the pump operation control: smooth start and stop, gradual change of speed, accuracy and stability of control.
- # Reduction of the repeated stress on the pump and piping resulting in longer equipment lifetime.
- # Elimination of the start-up current thanks to variable frequency drive that controls a gradual pump motor supply.



- # **Fast and easy installation and commissioning** thanks to the integration of a complete hydraulic module with buffer tank and immersed heating rods.
- # Compact and discreet design **for perfect architectural integration**.
- # **Excellent SEPR seasonal energy efficiencies**, which exceed the European EcoDesign 2021 requirements regarding high-temperature process cooling.
- # **Precise water temperature control** in cooling and heating modes thanks to highly efficient components.

CONTROL

- # eClimatic electronic controller and intelligent control parameters optimising part-load efficiency.
- # Integrated communication solutions offering flexibility (master/slave, Modbus).
- # DC Advanced display, equipped with a graphic screen providing access to the main user parameters, with two optional displays:
 - Remote Display
 - Service Display



CASING & DESIGN

- # Casing made of white painted galvanised steel.
- # Compact design, perfect for architectural integration.
- # All thermodynamic and hydraulic components installed inside the box.
- # Unit designed with reduced height for discreet installation on a roof or on the ground (up to 1.7m), without the need for a peripheral screen.
- # Optimized design for compact footprint, including water tank (as an option)

ACOUSTIC COMFORT

Three different noise level configurations available:

- # **Quiet operation** (standard), achieved with compact design, silent compressors and pumps, and with high-performance propeller fans, all installed in a closed box.
- # **Low noise level option:** High performance acoustic compressor jacket can have the noise produced by the unit.
- # **Active Acoustic Attenuation System** with variable fan speed allows progressive adaptation of the unit to the building load while respecting the noise level constraints and the operating limits (as an option).

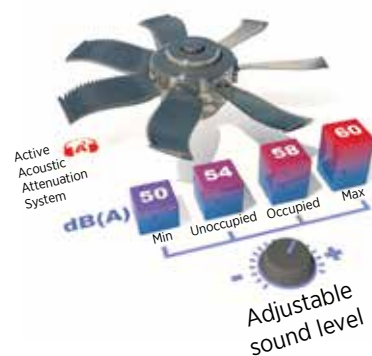

REMOTE MONITORING

- # Connectivity through **LennoxHydrocontrol**, a user-friendly interface for local supervision of the entire hydraulic system.
- # Connectivity through **LennoxCloud**
- # BMS through: **e-savvy**



THERMODYNAMIC SYSTEM

- # Multi-scroll compressors, mounted in tandem or trio, to provide the best seasonal efficiencies.
- # Aluminium microchannel condenser coil on cooling only units.
- # Large surface exchangers built with copper tubing and aluminium fins on heat-pump units.
- # High performance propeller fans with profiled blades to improve efficiency and reduce noise level (EC version in standard).
- # Thermally insulated and frost-protected water heat exchangers made from stainless steel plates with copper brazing.
- # One or two independent circuits, each equipped with electronic expansion valves.
- # R32 refrigerant (GWP = 675) enabling a decrease of the refrigerant load (-30%) and of the unit's carbon footprint (-75% TeqCO2)
- # Desuperheater (as an option): additional plate heat exchanger on each circuit to recover the rejected heat and provide free hot water for sanitary or industrial purposes.



INTEGRATED HYDRAULIC MODULE

- # Enables Plug & Play installation and reduced footprint
- # Available with eDrive technology (inverter) to reduce operation costs

G_(A) A_(B) C_(C) 035_(D) S_(E) P_(F) 1_(G) M_(H)

- (A) **G** = eComfort
- (B) **A** = Standard Air Cooled unit - **B** = Advanced air cooled unit
- (C) **C** = Cooling only unit - **H** = Heat pump unit
- (D) **035** = Approximate power in kW
- (E) **S** = Single circuit - **D** = Double circuit
- (F) **P** = Refrigerant R32
- (G) **1** = Revision number
- (H) **M** = 400V/3/50Hz



Air cooled version

Cooling only units

eCOMFORT - GAC		035S	040S	045S	050S	055S	060S		
Nominal thermal performances - Cooling mode									
Cooling capacity ⁽¹⁾		kW	38,4	41,6	47,5	51,8	63,6		
Total absorbed power ⁽¹⁾		kW	12,7	13,8	15,8	17,0	21,1		
EER ⁽¹⁾			3,02	3,00	3,02	3,05	3,02		
Comfort Application	Standard Fans	Seasonal Energy Efficiency Ratio ⁽²⁾ SEER		4,36	4,60	4,30	4,46	4,35	4,38
		Seasonal energy efficiency ⁽³⁾ η_{s,c}	%	171	181	169	175	171	172
Process Application	Standard Fans	Seasonal Energy Performance Ratio ⁽⁴⁾ SEPR - High temperature (7°C)		6,15	6,63	5,61	5,68	5,59	5,53
		Seasonal Energy Performance Ratio ⁽⁵⁾ SEPR - Medium temperature (-8°C)		3,68	3,88	3,83	3,80	3,81	3,81
Comfort Application	AC Fans	Seasonal Energy Efficiency Ratio ⁽²⁾ SEER		4,26	4,51	4,23	4,37	4,20	4,21
		Seasonal energy efficiency ⁽³⁾ η_{s,c}	%	167	177	166	172	165	165
Process Application	AC Fans	Seasonal Energy Performance Ratio ⁽⁴⁾ SEPR - High temperature (7°C)		5,78	6,30	5,41	5,49	5,23	5,18
		Seasonal Energy Performance Ratio ⁽⁵⁾ SEPR - Medium temperature (-8°C)		3,53	3,84	3,74	3,81	3,55	3,56
Nominal thermal performances - Heating mode									
Heating capacity ⁽¹⁾		kW	-	-	-	-	-		
Total absorbed power ⁽¹⁾		kW	-	-	-	-	-		
COP ⁽¹⁾			-	-	-	-	-		
Comfort Application	Standard Fans	Seasonal Coefficient of Performance ⁽⁶⁾ SCOP		-	-	-	-	-	
		Seasonal energy efficiency ⁽⁷⁾ η_{s,h}	%	-	-	-	-	-	
	AC Fans	Seasonal Coefficient of Performance ⁽⁶⁾ SCOP		-	-	-	-	-	
		Seasonal energy efficiency ⁽⁷⁾ η_{s,h}	%	-	-	-	-	-	
Acoustic data									
Global sound power level - Standard unit		dB(A)	75,3	75,3	74,4	74,9	75,3	78,6	
Electrical data									
Maximum power		kW	17,4	18,8	20,6	22,3	24,0	28,8	
Maximum current		A	28,1	31,0	35,4	38,1	40,9	47,5	
Starting current		A	116,0	108,4	146,6	157,6	160,4	164,4	
Short circuit current		kA	10,0	10,0	10,0	10,0	10,0	10,0	
Refrigeration circuit									
Number of circuits			1	1	1	1	1	1	
Number of compressors			2	2	2	2	2	2	
Total refrigerant load - R32		kg	3,0	3,5	3,7	4,5	4,6	4,7	
Evaporator									
Nominal water flow rate		m ³ /h	6,61	7,15	8,17	8,90	9,47	10,94	
Nominal pressure drop		kPa	17	25	27	36	30	39	
Hydraulic connection									
Type			Threaded male						
Diameter			1"1/2	1"1/2	1"1/2	1"1/2	1"1/2	1"1/2	

G^(A) A^(B) C^(C) 035^(D) S^(E) P^(F) 1^(G) M^(H)

- (A) **G** = eComfort
 (B) **A** = Standard Air Cooled unit - **B** = Advanced air cooled unit
 (C) **C** = Cooling only unit - **H** = Heat pump unit
 (D) **035** = Approximate power in kW
 (E) **S** = Single circuit - **D** = Double circuit
 (F) **P** = Refrigerant R32
 (G) **1** = Revision number
 (H) **M** = 400V/3/50Hz



Air cooled version

Cooling only units

eCOMFORT - GAC			065S	070S	080S	095S	110S	115S	125S	
Nominal thermal performances - Cooling mode										
Cooling capacity ⁽¹⁾		kW	64,3	70,0	86,3	95,8	108,3	119,3	128,8	
Total absorbed power ⁽¹⁾		kW	20,4	22,6	26,9	29,9	34,8	37,9	41,1	
EER ⁽¹⁾			3,14	3,09	3,21	3,20	3,11	3,15	3,13	
Comfort Application	Standard Fans	Seasonal Energy Efficiency Ratio ⁽²⁾ SEER		4,60	4,58	4,61	4,67	4,73	4,60	4,73
		Seasonal energy efficiency ⁽³⁾	%	181	180	181	184	186	181	186
Process Application	Standard Fans	Seasonal Energy Performance Ratio ⁽⁴⁾ SEPR - High temperature (7°C)		5,79	5,72	5,90	5,86	5,80	5,77	5,77
		Seasonal Energy Performance Ratio ⁽⁵⁾ SEPR - Medium temperature (-8°C)		3,81	3,83	3,96	3,87	3,90	3,93	3,91
Comfort Application	AC Fans	Seasonal Energy Efficiency Ratio ⁽²⁾ SEER		4,35	4,39	4,50	4,56	4,43	4,39	4,45
		Seasonal energy efficiency ⁽³⁾	%	171	173	177	179	174	173	175
Process Application	AC Fans	Seasonal Energy Performance Ratio ⁽⁴⁾ SEPR - High temperature (7°C)		5,37	5,35	5,66	5,68	5,35	5,35	5,47
		Seasonal Energy Performance Ratio ⁽⁵⁾ SEPR - Medium temperature (-8°C)		3,68	3,63	3,87	3,90	3,60	3,65	3,74
Nominal thermal performances - Heating mode										
Heating capacity ⁽¹⁾		kW	-	-	-	-	-	-	-	
Total absorbed power ⁽¹⁾		kW	-	-	-	-	-	-	-	
COP ⁽¹⁾			-	-	-	-	-	-	-	
Comfort Application	Standard Fans	Seasonal Coefficient of Performance ⁽⁶⁾ SCOP		-	-	-	-	-	-	
		Seasonal energy efficiency ⁽⁷⁾	%	-	-	-	-	-	-	
Comfort Application	AC Fans	Seasonal Coefficient of Performance ⁽⁶⁾ SCOP		-	-	-	-	-	-	
		Seasonal energy efficiency ⁽⁷⁾	%	-	-	-	-	-	-	
Acoustic data										
Global sound power level - Standard unit		dB(A)	77,9	78,5	80,2	84,1	84,1	86,3	82,6	
Electrical data										
Maximum power		kW	28,3	30,9	37,0	41,5	47,1	54,3	57,4	
Maximum current		A	47,0	52,6	62,9	70,0	79,2	90,0	96,9	
Starting current		A	163,8	208,8	219,1	273,3	320,3	331,2	253,1	
Short circuit current		kA	10,0	10,0	10,0	10,0	10,0	10,0	10,0	
Refrigeration circuit										
Number of circuits			1	1	1	1	1	1	1	
Number of compressors			2	2	2	2	2	2	3	
Total refrigerant load - R32		kg	6,0	6,2	7,4	9,0	9,2	9,4	9,2	
Evaporator										
Nominal water flow rate		m ³ /h	6,61	7,15	8,17	8,90	9,47	10,94	11,05	
Nominal pressure drop		kPa	17	25	27	36	30	39	33	
Hydraulic connection										
Type			Victaulic or Welded							
Diameter			2"	2"	2"	2"1/2	2"1/2	2"1/2	2"1/2	

- (1) EUROVENT certified data, in accordance with standard EN 14511.
Cooling mode: Evaporator water temperature = 12/7°C | Outdoor air temperature = 35°C / **Heating mode:** Condenser water temperature = 40/45°C | Outdoor air temperature = 7°C
 (2) SEER in accordance with standard EN 14825. | (3) Following ecodesign regulation EU 2016/2281 on process cooling, normalized leaving water temperature at 7°C, in accordance with standard EN 14825. | (4) Following ecodesign regulation EU 2016/2281 on process cooling units, normalized leaving water temperature at 7°C, in accordance with standard EN 14825. | (5) Following ecodesign regulation EU 2015/1095 on process cooling chillers, normalized leaving water temperature at -8°C, in accordance with standard EN 14825 | (6) SCOP in accordance with standard EN 14825. Heating mode performance is defined for average climate conditions. | (7) Following ecodesign regulation EU 813/2013 on space heaters, normalized leaving water temperature at 7°C, in accordance with standard EN 14825, average climate conditions. | (8) Following energy labelling regulation EU 811/2013 on space heaters.

G_(A) A_(B) C_(C) 035_(D) S_(E) P_(F) 1_(G) M_(H)

- (A) **G** = eComfort
- (B) **A** = Standard Air Cooled unit - **B** = Advanced air cooled unit
- (C) **C** = Cooling only unit - **H** = Heat pump unit
- (D) **035** = Approximate power in kW
- (E) **S** = Single circuit - **D** = Double circuit
- (F) **P** = Refrigerant R32
- (G) **1** = Revision number
- (H) **M** = 400V/3/50Hz



Air cooled version

Cooling only units

eCOMFORT - GAC		140S	110D	125D	140D	160D	185D	210D		
Nominal thermal performances - Cooling mode										
Cooling capacity ⁽¹⁾		kW	156,3	111,4	127,5	142,3	167,8	187,2	210,5	
Total absorbed power ⁽¹⁾		kW	51,1	36,9	41,9	46,6	53,6	60,7	69,9	
EER ⁽¹⁾			3,03	3,02	3,04	3,05	3,13	3,08	3,01	
Comfort Application	Standard Fans	Seasonal Energy Efficiency Ratio ⁽²⁾ SEER		4,53	4,66	4,60	4,65	4,72	4,71	4,64
		Seasonal energy efficiency ⁽³⁾ η_{s,c}	%	178	183	181	183	186	185	183
Process Application	Standard Fans	Seasonal Energy Performance Ratio ⁽⁴⁾ SEPR - High temperature (7°C)		5,52	5,70	5,54	5,51	5,80	5,64	5,45
		Seasonal Energy Performance Ratio ⁽⁵⁾ SEPR - Medium temperature (-8°C)		3,89	3,94	3,89	3,92	3,98	3,93	3,87
Comfort Application	AC Fans	Seasonal Energy Efficiency Ratio ⁽²⁾ SEER		4,35	4,60	4,46	4,48	4,64	4,60	4,36
		Seasonal energy efficiency ⁽³⁾ η_{s,c}	%	171	181	175	176	183	181	171
Process Application	AC Fans	Seasonal Energy Performance Ratio ⁽⁴⁾ SEPR - High temperature (7°C)		5,36	5,54	5,22	5,22	5,55	5,44	5,09
		Seasonal Energy Performance Ratio ⁽⁵⁾ SEPR - Medium temperature (-8°C)		3,71	3,93	3,67	3,71	3,87	3,85	3,56
Nominal thermal performances - Heating mode										
Heating capacity ⁽¹⁾		kW	-	-	-	-	-	-	-	
Total absorbed power ⁽¹⁾		kW	-	-	-	-	-	-	-	
COP ⁽¹⁾			-	-	-	-	-	-	-	
Comfort Application	Standard Fans	Seasonal Coefficient of Performance ⁽⁶⁾ SCOP		-	-	-	-	-	-	
		Seasonal energy efficiency ⁽⁷⁾ η_{s,h}	%	-	-	-	-	-	-	
AC Fans	AC Fans	Seasonal Coefficient of Performance ⁽⁶⁾ SCOP		-	-	-	-	-	-	
		Seasonal energy efficiency ⁽⁷⁾ η_{s,h}	%	-	-	-	-	-	-	
Seasonal efficiency class ⁽⁸⁾			-	-	-	-	-	-	-	
Acoustic data										
Global sound power level - Standard unit		dB(A)	88,3	78,3	81,6	84,1	83,2	87,5	87,5	
Electrical data										
Maximum power		kW	72,4	48,0	57,6	64,5	73,9	88,3	99,5	
Maximum current		A	120,0	81,6	95,0	108,6	125,6	147,5	165,8	
Starting current		A	323,3	201,1	211,8	264,8	281,8	350,8	407,0	
Short circuit current		kA	10,0	10,0	10,0	10,0	10,0	10,0	10,0	
Refrigeration circuit										
Number of circuits			1	2	2	2	2	2	2	
Number of compressors			3	4	4	4	4	4	4	
Total refrigerant load - R32		kg	9,4	9,0	9,2	9,4	14,5	15,0	15,2	
Evaporator										
Nominal water flow rate		m ³ /h	26,89	19,16	21,93	24,48	28,86	32,19	36,20	
Nominal pressure drop		kPa	42	56	46	61	58	61	58	
Hydraulic connection										
Type			Victaulic or Welded							
Diameter			2"1/2	2"1/2	2"1/2	2"1/2	3"	3"	3"	

G^(A) B^(B) C^(C) 040^(D) S^(E) P^(F) 1^(G) M^(H)

- (A) **G** = eComfort
 (B) **A** = Air cooled unit fix compressor - **B** = Advanced air cooled unit
 (C) **C** = Cooling only unit - **H** = Heat pump unit
 (D) **040** = Approximate power in kW
 (E) **S** = Single circuit - **D** = Double circuit
 (F) **P** = Refrigerant R32
 (G) **1** = Revision number
 (H) **M** = 400V/3/50Hz



Advanced Air cooled version Inverter

Cooling only units

eCOMFORT - GBC		040S	060S	070S	080S	110S	120S	125D	140D		
Nominal thermal performances - Cooling mode											
Cooling capacity ⁽¹⁾		kW	34,5	51,3	61,5	77,4	94,6	117,0	124,8	146,7	
Total absorbed power ⁽¹⁾		kW	10,2	15,8	19,5	23,9	28,9	36,8	40,9	48,6	
EER ⁽¹⁾			3,38	3,24	3,15	3,24	3,28	3,18	3,05	3,02	
Comfort Application	EC Fans	Seasonal Energy Efficiency Ratio ⁽²⁾ SEER		5,0	4,9	4,8	4,8	4,9	5,0	5,0	
		Seasonal energy efficiency ⁽³⁾ η_{s,c}	%	195,2	193,1	190,1	190,5	194,3	192,5	195,4	197,5
Process Application	EC Fans	Seasonal Energy Performance Ratio ⁽⁴⁾ SEPR - High temperature (7°C)		5,7	5,5	5,5	5,5	5,6	5,5	5,7	
		Seasonal Energy Performance Ratio ⁽⁵⁾ SEPR - Medium temperature (-8°C)		3,57	3,67	3,41	3,44	3,58	3,48	3,68	3,74
Nominal thermal performances - Heating mode											
Heating capacity ⁽¹⁾		kW	-	-	-	-	-	-	-	-	
Total absorbed power ⁽¹⁾		kW	-	-	-	-	-	-	-	-	
COP ⁽¹⁾			-	-	-	-	-	-	-	-	
Comfort Application	EC Fans	Seasonal Coefficient of Performance ⁽⁶⁾ SCOP		-	-	-	-	-	-	-	
		Seasonal energy efficiency ⁽⁷⁾ η_{s,h}	%	-	-	-	-	-	-	-	-
Acoustic data											
Global sound power level - Standard unit		dB(A)	82,5	83,3	82,8	84,1	84	86,3	84,4	86,1	
Electrical data											
Maximum power		kW	16,4	25,3	28,7	37,5	42,4	55,2	58	68,3	
Maximum current		A	26,1	41	47,1	61,4	70,5	90,5	95,1	113,4	
Starting current		A	26,1	41	166,6	217,6	226,7	331,7	211,9	269,6	
Short circuit current		kA	10								
Refrigeration circuit											
Number of circuits			1	1	1	1	1	2	2	2	
Number of compressors			1	1	2	2	2	2	2+2	2+2	
Total refrigerant load - R32		kg	3,6	4,6	6	7,4	8,8	9	9,2	9,4	
Evaporator											
Nominal water flow rate		m ³ /h	5,96	8,85	10,61	13,35	16,31	20,17	21,53	25,31	
Nominal pressure drop		kPa	23	29	31	33	30	29	25	22	
Hydraulic connection											
Type			Threaded male			Victaulic or Welded					
Diameter			1"1/2			2		2"1/2			

(1) EUROVENT certified data, in accordance with standard EN 14511.

Cooling mode: Evaporator water temperature = 12/7°C | Outdoor air temperature = 35°C / **Heating mode:** Condenser water temperature = 40/45°C | Outdoor air temperature = 7°C
 (2) SEER in accordance with standard EN 14825. | (3) Following ecodesign regulation EU 2016/2281 on space cooling, normalized leaving water temperature at 7°C, in accordance with standard EN 14825. | (4) Following ecodesign regulation EU 2016/2281 on process cooling units, normalized leaving water temperature at 7°C, in accordance with standard EN 14825. | (5) Following ecodesign regulation EU 2015/1095 on process cooling chillers, normalized leaving water temperature at -8°C, in accordance with standard EN 14825. | (6) SCOP in accordance with standard EN 14825. Heating mode performance is defined for average climate conditions. | (7) Following ecodesign regulation EU 813/2013 on space heaters, normalized leaving water temperature at 7°C, in accordance with standard EN 14825, average climate conditions. | (8) Following energy labelling regulation EU 811/2013 on space heaters.

G_(A) B_(B) C_(C) 040_(D) S_(E) P_(F) 1_(G) M_(H)

- (A) **G** = eComfort
- (B) **A** = Air cooled unit fix compressor - **B** = Advanced air cooled unit
- (C) **C** = Cooling only unit - **H** = Heat pump unit
- (D) **040** = Approximate power in kW
- (E) **S** = Single circuit - **D** = Double circuit
- (F) **P** = Refrigerant R32
- (G) **1** = Revision number
- (H) **M** = 400V/3/50Hz



Advanced air cooled version *Inverter*

Cooling only units

eCOMFORT - GBC		160D	185D	210D		
Nominal thermal performances - Cooling mode						
Cooling capacity ⁽¹⁾		kW	159,5	170,0	196,6	
Total absorbed power ⁽¹⁾		kW	50,6	54,1	64,2	
EER ⁽¹⁾			3,15	3,14	3,06	
Comfort Application	EC Fans	Seasonal Energy Efficiency Ratio ⁽²⁾ SEER		5.05	5.03	5.08
		Seasonal energy efficiency ⁽³⁾ η_{s,c}	%	199	198	200
Process Application	EC Fans	Seasonal Energy Performance Ratio ⁽⁴⁾ SEPR - High temperature (7°C)		6.01	5.95	5.64
		Seasonal Energy Performance Ratio ⁽⁵⁾ SEPR - Medium temperature (-8°C)		3.77	3.75	3.7
Nominal thermal performances - Heating mode						
Heating capacity ⁽¹⁾		kW	-	-	-	
Total absorbed power ⁽¹⁾		kW	-	-	-	
COP ⁽¹⁾			-	-	-	
Comfort Application	EC Fans	Seasonal Coefficient of Performance ⁽⁶⁾ SCOP		-	-	-
		Seasonal energy efficiency ⁽⁷⁾ η_{s,h}	%	-	-	-
Acoustic data						
Global sound power level - Standard unit		dB(A)	85,2	87,3	87,5	
Electrical data						
Maximum power		kW	71.7	81.6	94.8	
Maximum current		A	120	135.1	157.1	
Starting current		A	276.3	338.5	398.3	
Short circuit current		kA		10		
Refrigeration circuit						
Number of circuits			2	2	2	
Number of compressors			2+2	2+2	2+2	
Total refrigerant load - R32		kg	14,6	15	15,2	
Evaporator						
Nominal water flow rate		m ³ /h	27,52	29,32	33,91	
Nominal pressure drop		kPa	26	26	34	
Hydraulic connection						
Type			Victaulic or Welded			
Diameter			3"			

(1) EUROVENT certified data, in accordance with standard EN 14511.

Cooling mode: Evaporator water temperature = 12/7°C | Outdoor air temperature = 35°C / **Heating mode:** Condenser water temperature = 40/45°C | Outdoor air temperature = 7°C
 (2) SEER in accordance with standard EN 14825. | (3) Following ecodesign regulation EU 2016/2281 on space cooling, normalized leaving water temperature at 7°C, in accordance with standard EN 14825. |
 (4) Following ecodesign regulation EU 2016/2281 on process cooling units, normalized leaving water temperature at 7°C, in accordance with standard EN 14825. |
 (5) Following ecodesign regulation EU 2015/1095 on process cooling chillers, normalized leaving water temperature at -8°C, in accordance with standard EN 14825. |
 (6) SCOP in accordance with standard EN 14825. Heating mode performance is defined for average climate conditions. | (7) Following ecodesign regulation EU 813/2013 on space heaters, normalized leaving water temperature at 7°C, in accordance with standard EN 14825, average climate conditions. | (8) Following energy labelling regulation EU 811/2013 on space heaters.

G^(A) A^(B) H^(C) 035^(D) S^(E) P^(F) 1^(G) M^(H)

- (A) **G** = eComfort
 (B) **A** = Standard Air Cooled unit - **B** = Advanced air cooled unit
 (C) **C** = Cooling only unit - **H** = Heat pump unit
 (D) **035** = Approximate power in kW
 (E) **S** = Single circuit - **D** = Double circuit
 (F) **P** = Refrigerant R32
 (G) **1 or 2** = Revision number
 (H) **M** = 400V/3/50Hz



Air cooled version

Heat pumps units

eCOMFORT - GAH		035S	040S	045S	050S	055S	060S		
Nominal thermal performances - Cooling mode									
Cooling capacity ⁽¹⁾		kW	37,7	41,2	46,9	50,5	56,1	63,2	
Total absorbed power ⁽¹⁾		kW	13,2	14,2	16,5	17,7	19,0	22,0	
EER ⁽¹⁾			2,87	2,90	2,85	2,86	2,96	2,87	
Comfort Application	Standard Fans	Seasonal Energy Efficiency Ratio ⁽²⁾ SEER		4,21	4,48	4,26	4,33	4,18	4,18
		Seasonal energy efficiency ⁽³⁾ η_{s,c}	%	165	176	167	170	164	164
Process Application	Standard Fans	Seasonal Energy Performance Ratio ⁽⁴⁾ SEPR - High temperature (7°C)		6,03	6,58	5,58	5,59	5,50	5,43
		Seasonal Energy Performance Ratio ⁽⁵⁾ SEPR - Medium temperature (-8°C)		3,71	3,94	3,89	3,85	3,87	3,86
Comfort Application	AC Fans	Seasonal Energy Efficiency Ratio ⁽²⁾ SEER		4,15	4,40	4,19	4,25	4,13	4,15
		Seasonal energy efficiency ⁽³⁾ η_{s,c}	%	163	173	165	167	162	163
Process Application	AC Fans	Seasonal Energy Performance Ratio ⁽⁴⁾ SEPR - High temperature (7°C)		5,71	6,21	5,38	5,40	5,17	5,14
		Seasonal Energy Performance Ratio ⁽⁵⁾ SEPR - Medium temperature (-8°C)		3,52	3,83	3,75	3,77	3,53	3,55
Nominal thermal performances - Heating mode									
Heating capacity ⁽¹⁾		kW	39,0	42,1	48,4	52,2	56,6	64,2	
Total absorbed power ⁽¹⁾		kW	13,2	14,1	15,8	17,4	18,9	21,8	
COP ⁽¹⁾			2,95	2,99	3,06	2,99	2,99	2,95	
Comfort Application	Standard Fans	Seasonal Coefficient of Performance ⁽⁶⁾ SCOP		3,46	3,54	3,57	3,56	3,54	3,54
		Seasonal energy efficiency ⁽⁷⁾ η_{s,h}	%	136	139	140	140	139	139
Comfort Application	AC Fans	Seasonal Coefficient of Performance ⁽⁶⁾ SCOP		3,31	3,44	3,45	3,49	3,28	3,30
		Seasonal energy efficiency ⁽⁷⁾ η_{s,h}	%	129	134	135	137	128	129
Seasonal efficiency class ⁽⁸⁾			A+	A+	A+	A+	A+	A+	
Acoustic data									
Global sound power level - Standard unit		dB(A)	75,3	75,3	74,4	74,9	75,3	78,6	
Electrical data									
Maximum power		kW	17,4	18,8	20,6	22,3	25,4	28,8	
Maximum current		A	28,1	31,0	35,4	38,1	42,9	47,5	
Starting current		A	116,0	108,4	146,6	157,6	162,4	164,4	
Short circuit current		kA	10	10	10	10	10	10	
Refrigeration circuit									
Number of circuits			1	1	1	1	1	1	
Number of compressors			2	2	2	2	2	2	
Total refrigerant load - R32		kg	5,2	5,8	6,5	8,0	8,3	9,0	
Evaporator									
Nominal water flow rate		m ³ /h	6,49	7,09	8,07	8,69	9,65	10,87	
Nominal pressure drop		kPa	37	32	30	34	34	33	
Hydraulic connection									
Type			Threaded male						
Diameter			1"1/2	1"1/2	1"1/2	1"1/2	1"1/2	1"1/2	

- (1) EUROVENT certified data, in accordance with standard EN 14511.
Cooling mode: Evaporator water temperature = 12/7°C | Outdoor air temperature = 35°C / **Heating mode:** Condenser water temperature = 40/45°C | Outdoor air temperature = 7°C
 (2) SEER in accordance with standard EN 14825. | (3) Following ecodesign regulation EU 2016/2281 on process cooling, normalized leaving water temperature at 7°C, in accordance with standard EN 14825. | (4) Following ecodesign regulation EU 2016/2281 on process cooling units, normalized leaving water temperature at 7°C, in accordance with standard EN 14825. | (5) Following ecodesign regulation EU 2015/1095 on process cooling chillers, normalized leaving water temperature at -8°C, in accordance with standard EN 14825 | (6) SCOP in accordance with standard EN 14825. Heating mode performance is defined for average climate conditions. | (7) Following ecodesign regulation EU 813/2013 on space heaters, normalized leaving water temperature at 7°C, in accordance with standard EN 14825, average climate conditions. | (8) Following energy labelling regulation EU 811/2013 on space heaters.

G_(A) A_(B) H_(C) 035_(D) S_(E) P_(F) 1_(G) M_(H)

- (A) **G** = eComfort
- (B) **A** = Standard Air Cooled unit - **B** = Advanced air cooled unit
- (C) **C** = Cooling only unit - **H** = Heat pump unit
- (D) **035** = Approximate power in kW
- (E) **S** = Single circuit - **D** = Double circuit
- (F) **P** = Refrigerant R32
- (G) **1 or 2** = Revision number
- (H) **M** = 400V/3/50Hz



Air cooled version

Heat pumps units

eCOMFORT - GAH		065S	070S	080S	095S	110S	115S	125S		
Nominal thermal performances - Cooling mode										
Cooling capacity ⁽¹⁾		kW	64,3	69,6	84,7	94,1	105,3	118,0	126,4	
Total absorbed power ⁽¹⁾		kW	20,8	23,1	27,7	30,9	36,4	39,4	42,7	
EER ⁽¹⁾			3,09	3,02	3,06	3,05	2,90	2,99	2,96	
Comfort Application	Standard Fans	Seasonal Energy Efficiency Ratio ⁽²⁾ SEER		4,56	4,53	4,46	4,56	4,60	4,39	4,62
		Seasonal energy efficiency ⁽³⁾ η_{s,c}	%	179	178	175	180	181	173	182
Process Application	Standard Fans	Seasonal Energy Performance Ratio ⁽⁴⁾ SEPR - High temperature (7°C)		5,78	5,69	5,82	5,81	5,73	5,59	5,65
		Seasonal Energy Performance Ratio ⁽⁵⁾ SEPR - Medium temperature (-8°C)		3,92	3,88	3,99	3,93	3,94	3,94	3,90
Comfort Application	AC Fans	Seasonal Energy Efficiency Ratio ⁽²⁾ SEER		4,28	4,35	4,40	4,46	4,34	4,27	4,37
		Seasonal energy efficiency ⁽³⁾ η_{s,c}	%	168	171	173	175	171	168	172
Process Application	AC Fans	Seasonal Energy Performance Ratio ⁽⁴⁾ SEPR - High temperature (7°C)		5,29	5,32	5,57	5,58	5,25	5,24	5,39
		Seasonal Energy Performance Ratio ⁽⁵⁾ SEPR - Medium temperature (-8°C)		3,64	3,64	3,84	3,87	3,57	3,60	3,69
Nominal thermal performances - Heating mode										
Heating capacity ⁽¹⁾		kW	64,9	70,4	84,9	94,8	106,7	117,5	126,1	
Total absorbed power ⁽¹⁾		kW	20,4	23,0	26,8	30,1	33,9	38,9	40,7	
COP ⁽¹⁾			3,18	3,06	3,17	3,15	3,15	3,02	3,10	
Comfort Application	Standard Fans	Seasonal Coefficient of Performance ⁽⁶⁾ SCOP		3,65	3,63	3,63	3,59	3,61	3,58	3,73
		Seasonal energy efficiency ⁽⁷⁾ η_{s,h}	%	143	142	142	141	141	140	146
Comfort Application	AC Fans	Seasonal Coefficient of Performance ⁽⁶⁾ SCOP		3,58	3,64	3,50	3,61	3,51	3,31	3,71
		Seasonal energy efficiency ⁽⁷⁾ η_{s,h}	%	140	143	137	141	137	129	146
Seasonal efficiency class ⁽⁸⁾			A+	A+	A+	A+	A+	A+	A+	
Acoustic data										
Global sound power level - Standard unit		dB(A)	77,9	78,5	80,2	84,1	84,1	86,3	82,6	
Electrical data										
Maximum power		kW	28,3	30,9	37,0	41,5	47,1	54,3	57,4	
Maximum current		A	47,0	52,6	62,9	70,0	79,2	90,0	96,9	
Starting current		A	163,8	208,8	219,1	273,3	320,3	331,2	253,1	
Short circuit current		kA	10	10	10	10	10	10	10	
Refrigeration circuit										
Number of circuits			1	1	1	1	1	1	1	
Number of compressors			2	2	2	2	2	2	3	
Total refrigerant load - R32		kg	10,0	10,5	12,5	17,0	17,5	17,5	18,0	
Evaporator										
Nominal water flow rate		m ³ /h	11,06	11,98	14,57	16,19	18,12	20,29	21,74	
Nominal pressure drop		kPa	34	39	39	48	36	45	34	
Hydraulic connection										
Type			Victaulic or Welded							
Diameter			2"	2"	2"	2"1/2	2"1/3	2"1/4	2"1/5	

G^(A) A^(B) H^(C) 035^(D) S^(E) P^(F) 1^(G) M^(H)

- (A) **G** = eComfort
 (B) **A** = Standard Air Cooled unit - **B** = Advanced air cooled unit
 (C) **C** = Cooling only unit - **H** = Heat pump unit
 (D) **035** = Approximate power in kW
 (E) **S** = Single circuit - **D** = Double circuit
 (F) **P** = Refrigerant R32
 (G) **1 or 2** = Revision number
 (H) **M** = 400V/3/50Hz



Air cooled version

Heat pumps units

eCOMFORT - GAH			140S	110D	125D	140D	160D	185D	210D	
Nominal thermal performances - Cooling mode										
Cooling capacity ⁽¹⁾		kW	152,0	108,6	125,3	140,3	166,1	187,3	209,1	
Total absorbed power ⁽¹⁾		kW	54,8	38,4	43,3	48,4	55,1	62,5	73,0	
EER ⁽¹⁾			2,78	2,83	2,89	2,90	3,01	3,00	2,86	
Comfort Application	Standard Fans	Seasonal Energy Efficiency Ratio ⁽²⁾ SEER		4,36	4,56	4,42	4,49	4,62	4,56	4,49
		Seasonal energy efficiency ⁽³⁾ η_{s,c}	%	171	179	174	177	182	179	176
Process Application	Standard Fans	Seasonal Energy Performance Ratio ⁽⁴⁾ SEPR - High temperature (7°C)		5,31	5,64	5,40	5,36	5,73	5,49	5,27
		Seasonal Energy Performance Ratio ⁽⁵⁾ SEPR - Medium temperature (-8°C)		3,85	3,92	3,84	3,85	3,99	3,92	3,82
Comfort Application	AC Fans	Seasonal Energy Efficiency Ratio ⁽²⁾ SEER		4,25	4,48	4,35	4,38	4,55	4,50	4,26
		Seasonal energy efficiency ⁽³⁾ η_{s,c}	%	167	176	171	172	179	177	167
Process Application	AC Fans	Seasonal Energy Performance Ratio ⁽⁴⁾ SEPR - High temperature (7°C)		5,25	5,47	5,11	5,10	5,48	5,34	4,95
		Seasonal Energy Performance Ratio ⁽⁵⁾ SEPR - Medium temperature (-8°C)		3,65	3,88	3,61	3,64	3,85	3,81	3,50
Nominal thermal performances - Heating mode										
Heating capacity ⁽¹⁾		kW	154,5	114,0	129,3	142,5	170,7	190,3	216,0	
Total absorbed power ⁽¹⁾		kW	52,9	35,4	41,4	45,9	53,3	61,0	72,9	
COP ⁽¹⁾			2,92	3,22	3,12	3,11	3,20	3,12	2,96	
Comfort Application	Standard Fans	Seasonal Coefficient of Performance ⁽⁶⁾ SCOP		3,70	3,78	3,76	3,79	3,78	3,74	3,71
		Seasonal energy efficiency ⁽⁷⁾ η_{s,h}	%	145	148	147	148	148	147	145
Comfort Application	AC Fans	Seasonal Coefficient of Performance ⁽⁶⁾ SCOP		3,54	3,71	3,48	3,51	3,64	3,64	3,38
		Seasonal energy efficiency ⁽⁷⁾ η_{s,h}	%	139	145	136	138	143	143	132
Seasonal efficiency class ⁽⁸⁾			A+	A+	A+	A+	A+	A+	A+	
Acoustic data										
Global sound power level - Standard unit		dB(A)	88,3	78,3	81,6	84,1	83,2	87,5	87,5	
Electrical data										
Maximum power		kW	72,4	48,0	57,6	64,5	73,9	88,3	99,5	
Maximum current		A	120,0	81,6	95,0	108,6	125,6	147,5	165,8	
Starting current		A	323,3	201,1	211,8	264,8	281,8	350,8	407,0	
Short circuit current		kA	10	10	10	10	10	10	10	
Refrigeration circuit										
Number of circuits			1	2	2	2	2	2	2	
Number of compressors			3	4	4	4	4	4	2+2	
Total refrigerant load - R32		kg	18,3	17,8	19,0	20,0	27,0	27,5	28,0	
Evaporator										
Nominal water flow rate		m ³ /h	26,14	18,68	21,55	24,13	28,56	32,21	35,97	
Nominal pressure drop		kPa	48	20	25	21	28	31	38	
Hydraulic connection										
Type			Victaulic or Welded							
Diameter			2"1/6	2"1/7	2"1/8	2"1/9	3"	3"	3"	

- (1) EUROVENT certified data, in accordance with standard EN 14511.
Cooling mode: Evaporator water temperature = 12/7°C | Outdoor air temperature = 35°C / **Heating mode:** Condenser water temperature = 40/45°C | Outdoor air temperature = 7°C
 (2) SEER in accordance with standard EN 14825. | (3) Following ecodesign regulation EU 2016/2281 on process cooling, normalized leaving water temperature at 7°C, in accordance with standard EN 14825. | (4) Following ecodesign regulation EU 2016/2281 on process cooling units, normalized leaving water temperature at 7°C, in accordance with standard EN 14825. | (5) Following ecodesign regulation EU 2015/1095 on process cooling chillers, normalized leaving water temperature at -8°C, in accordance with standard EN 14825 | (6) SCOP in accordance with standard EN 14825. Heating mode performance is defined for average climate conditions. | (7) Following ecodesign regulation EU 813/2013 on space heaters, normalized leaving water temperature at 7°C, in accordance with standard EN 14825, average climate conditions. | (8) Following energy labelling regulation EU 811/2013 on space heaters.

G_(A) B_(B) H_(C) 040_(D) S_(E) P_(F) 1_(G) M_(H)

- (A) **G** = eComfort
- (B) **A** = Standard Air Cooled unit - **B** = Advanced air cooled unit
- (C) **C** = Cooling only unit - **H** = Heat pump unit
- (D) **040** = Approximate power in kW
- (E) **S** = Single circuit - **D** = Double circuit
- (F) **P** = Refrigerant R32
- (G) **1** = Revision number
- (H) **M** = 400V/3/50Hz



Advanced air cooled version Inverter

Heat pumps units

eCOMFORT - GBH		040S	060S	070S	080S	110S	120S		
Nominal thermal performances - Cooling mode									
Cooling capacity ⁽¹⁾		kW	33,6	50,0	60,6	71,9	87,6	109,2	
Total absorbed power ⁽¹⁾		kW	10,4	16,0	19,7	24,0	29,1	37,6	
EER ⁽¹⁾			3,22	3,12	3,07	3,00	3,01	2,90	
Comfort Application	EC Fans	Seasonal Energy Efficiency Ratio ⁽²⁾ SEER		4.73	4.73	4.6	4.6	4.68	4.68
		Seasonal energy efficiency ⁽³⁾ η_{s,c}	%	186	186	181	181	184	184
Process Application	EC Fans	Seasonal Energy Performance Ratio ⁽⁴⁾ SEPR - High temperature (7°C)		6.52	6.29	5.7	5.57	5.75	5.51
		Seasonal Energy Performance Ratio ⁽⁵⁾ SEPR - Medium temperature (-8°C)		3.66	3.7	3.32	3.08	3.24	3.14
Nominal thermal performances - Heating mode									
Heating capacity ⁽¹⁾		kW	34,4	51,1	64,0	78,4	94,0	116,5	
Total absorbed power ⁽¹⁾		kW	10,3	15,3	19,8	24,3	28,6	37,8	
COP ⁽¹⁾			3,36	3,33	3,23	3,23	3,29	3,08	
Comfort Application	EC Fans	Seasonal Coefficient of Performance ⁽⁶⁾ SCOP		3.93	3.93	4	3.95	4.05	4.05
		Seasonal energy efficiency ⁽⁷⁾ η_{s,h}	%	154	154	157	155	159	159
Acoustic data									
Global sound power level - Standard unit		dB(A)	82,5	83,3	82,8	84,1	84	86,3	
Electrical data									
Maximum power		kW	16.4	25.3	28.7	37.5	42.4	55.2	
Maximum current		A	26.1	41	47.1	61.4	70.5	90.5	
Starting current		A	26.1	41	166.6	217.6	226.7	331.7	
Short circuit current		kA	10	10	10	10	10	10	
Refrigeration circuit									
Number of circuits			1	1	1	1	1	1	
Number of compressors			2	2	2	2	2	2	
Total refrigerant load - R32		kg	6,5	8,2	10,5	14	18,5	21	
Evaporator									
Nominal water flow rate		m ³ /h	11,06	11,98	14,57	16,19	18,12	20,29	
Nominal pressure drop		kPa	34	39	39	48	36	45	
Hydraulic connection									
Type		Victaulic or Welded							
Diameter			2"	2"	2"	2"1/2	2"1/3	2"1/4	

(1) EUROVENT certified data, in accordance with standard EN 14511.

Cooling mode: Evaporator water temperature = 12/7°C | Outdoor air temperature = 35°C / **Heating mode:** Condenser water temperature = 40/45°C | Outdoor air temperature = 7°C

(2) SEER in accordance with standard EN 14825. | (3) Following ecodesign regulation EU 2016/2281 on space cooling, normalized leaving water temperature at 7°C, in accordance with standard EN 14825. | (4) Following ecodesign regulation EU 2016/2281 on process cooling units, normalized leaving water temperature at 7°C, in accordance with standard EN 14825. |

(5) Following ecodesign regulation EU 2015/1095 on process cooling chillers, normalized leaving water temperature at -8°C, in accordance with standard EN 14825. |

(6) SCOP in accordance with standard EN 14825. Heating mode performance is defined for average climate conditions. | (7) Following ecodesign regulation EU 813/2013 on space heaters, normalized leaving water temperature at 7°C, in accordance with standard EN 14825, average climate conditions. | (8) Following energy labelling regulation EU 811/2013 on space heaters.

G^(A) B^(B) H^(C) 040^(D) S^(E) P^(F) 1^(G) M^(H)

- (A) **G** = eComfort
 (B) **A** = Standard Air Cooled unit - **B** = Advanced air cooled unit
 (C) **C** = Cooling only unit - **H** = Heat pump unit
 (D) **040** = Approximate power in kW
 (E) **S** = Single circuit - **D** = Double circuit
 (F) **P** = Refrigerant R32
 (G) **1** = Revision number
 (H) **M** = 400V/3/50Hz



Advanced air cooled version Inverter

Heat pumps units

eCOMFORT - GBH		125D	140D	160D	185D	210D		
Nominal thermal performances - Cooling mode								
Cooling capacity ⁽¹⁾		kW	126,8	146,9	161,1	171,3	199,9	
Total absorbed power ⁽¹⁾		kW	40,4	48,2	49,9	53,6	65,3	
EER ⁽¹⁾			3,14	3,05	3,23	3,20	3,06	
Comfort Application	EC Fans	Seasonal Energy Efficiency Ratio ⁽²⁾ SEER		4.85	4.8	4.98	4.9	4.95
		Seasonal energy efficiency ⁽³⁾ $\eta_{s,c}$	%	191	189	196	193	195
Process Application	EC Fans	Seasonal Energy Performance Ratio ⁽⁴⁾ SEPR - High temperature (7°C)		5.59	5.34	5.93	5.69	5.46
		Seasonal Energy Performance Ratio ⁽⁵⁾ SEPR - Medium temperature (-8°C)		3.66	3.67	3.78	3.76	3.69
Nominal thermal performances - Heating mode								
Heating capacity ⁽¹⁾		kW	126,8	146,9	161,1	171,3	199,9	
Total absorbed power ⁽¹⁾		kW	40,4	48,2	49,9	53,6	65,3	
COP ⁽¹⁾			3,14	3,05	3,23	3,20	3,06	
Comfort Application	EC Fans	Seasonal Coefficient of Performance ⁽⁶⁾ SCOP		3.88	3.88	3.9	3.88	3.93
		Seasonal energy efficiency ⁽⁷⁾ $\eta_{s,h}$	%	152	152	153	152	154
Acoustic data								
Global sound power level - Standard unit		dB(A)	84,4	86,1	85,2	87,3	87,5	
Electrical data								
Maximum power		kW	58	68.3	71.7	81.6	94.8	
Maximum current		A	95.1	113.4	120	135.1	157.1	
Starting current		A	211.9	269.6	276.3	338.5	398.3	
Short circuit current		kA	10	10	10	10	10	
Refrigeration circuit								
Number of circuits			2	2	2	2	2	
Number of compressors			2+2	2+2	2+2	2+2	2+2	
Total refrigerant load - R32		kg	20	22	27	27,2	27,6	
Evaporator								
Nominal water flow rate		m ³ /h	21,31	24,85	27,28	29,31	33,8	
Nominal pressure drop		kPa	25	22	26	26	34	
Hydraulic connection								
Type		Victaulic or Welded						
Diameter		2"1/2			3"			

(1) EUROVENT certified data, in accordance with standard EN 14511.

Cooling mode: Evaporator water temperature = 12/7°C | Outdoor air temperature = 35°C / **Heating mode:** Condenser water temperature = 40/45°C | Outdoor air temperature = 7°C
 (2) SEER in accordance with standard EN 14825. | (3) Following ecodesign regulation EU 2016/2281 on space cooling, normalized leaving water temperature at 7°C, in accordance with standard EN 14825. | (4) Following ecodesign regulation EU 2016/2281 on process cooling units, normalized leaving water temperature at 7°C, in accordance with standard EN 14825. | (5) Following ecodesign regulation EU 2015/1095 on process cooling chillers, normalized leaving water temperature at -8°C, in accordance with standard EN 14825. | (6) SCOP in accordance with standard EN 14825. Heating mode performance is defined for average climate conditions. | (7) Following ecodesign regulation EU 813/2013 on space heaters, normalized leaving water temperature at 7°C, in accordance with standard EN 14825, average climate conditions. | (8) Following energy labelling regulation EU 811/2013 on space heaters.



Air cooled version

Cooling only units

eCOMFORT - GAC		035S	040S	045S	050S	055S	060S	065S	070S	080S
A	mm	1125			1125			2250		
B		1320			1320			1320		
C		1740			2109			1779		
Weight of standard units										
Basic unit	kg	325	339	350	379	385	405	565	559	605



Air cooled version

Cooling only units

eCOMFORT - GAC		095S	110S	115S	125S	140S	110D	125D	140D	160D	185D	210D
A	mm	2250			2250			2250			2250	
B		1320			1740			2650			2650	
C		2071			2071			2071			2071	
Weight of standard units												
Basic unit	kg	679	701	730	846	932	893	932	911	1216	1340	1340



Advanced air cooled version

Cooling only units

eCOMFORT - GBC		040S	060S	070S	080S	110S	120S
A	mm	1125		2250		2250	
B		1320		1320		1320	
C		1740	2109	1779	1779	2071	2071
Weight of standard units							
Basic unit	kg	332	367	547	640	682	721



Advanced air cooled version

Cooling only units

eCOMFORT - GBC		125D	140D	160D	185D	210D	
A	mm	2250		2250		2250	
B		1740		2650		2650	
C		2071		2071		2071	
Weight of standard units							
Basic unit	kg	894	949	1201	1283	1283	



Air cooled version

Heat pumps units

eCOMFORT - GAH		035S	040S	045S	050S	055S	060S	065S	070S	080S
A	mm	1125			1125			2250		
B		1320			1320			1320		
C		1740			2109			1779		
Weight of standard units										
Basic unit	kg	350	369	385	416	424	448	614	608	649



Air cooled version

Heat pumps units

eCOMFORT - GAH		095S	110S	115S	125S	140S	110D	125D	140D	160D	185D	210D
A	mm	2250			2250			2250			2250	
B		1320			1740			1320			2650	
C		2071			2071			2071			2071	
Weight of standard units												
Basic unit	kg	742	771	793	918	1006	975	1017	998	1388	1463	1463



Advanced air cooled version

Heat pumps units

eCOMFORT - GBH		040S	060S	070S	080S	110S	120S
A	mm	1125	1125	2250	2250	2250	2250
B		1320	1320	1320	1320	1320	1320
C		1740	2109	1770	1779	2071	2071
Weight of standard units							
Basic unit	kg	351	401	609	705	746	789



Advanced air cooled version

Heat pumps units

eCOMFORT - GBH		125S	140S	160S	185S	210S
A	mm	2250	2250	2250	2250	2250
B		1740	1740	2650	2650	2650
C		2071	2071	2071	2071	2071
Weight of standard units						
Basic unit	kg	1001	1065	1360	1427	1427

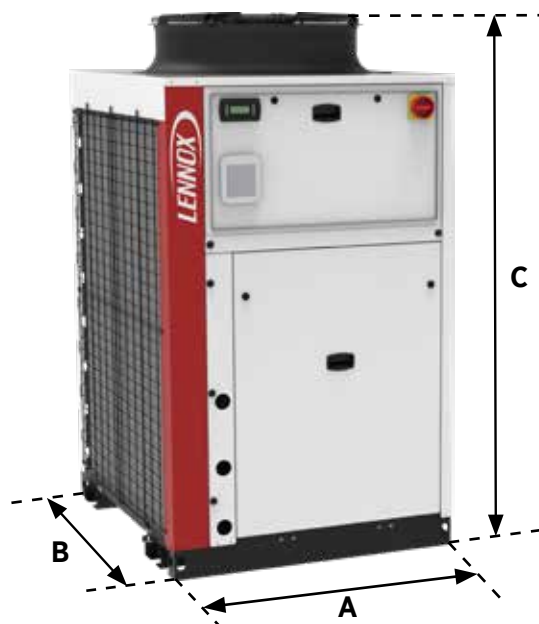

eProcess

Water and air condensing screw chillers



R1234
ze

R515B

R134a

R513A



R1234
ze

R515B

AIR COOLED

310 - 1550 kW



WATER COOLED

280 - 1220 kW



R513A

AIR COOLED

330 - 1950 kW



WATER COOLED

200 - 1450 kW



R134a

AIR COOLED

330 - 1950 kW



LENNOX participates in the ECP programme for LCP-HP. Check ongoing validity of certificate : www.eurovent-certification.com

- # **Air or water condensing units, with various refrigerant options**, which meet all environmental and building requirements.
- # Precise control of the compressor speed stabilizes the water temperature and ensures comfort.
- # **Multiple versions available to ensure the perfect match with every application**, standard version, high efficiency version and super "low noise" version.
- # **Inverter compressors available in two versions:**
 - eProcess Plus : one inverter compressor per unit, with a focus on energy saving and high efficiency..
 - eProcess Premiere : All inverter compressors for precision operation and premium efficiency.

THERMODYNAMIC SYSTEM

- # Compressors with linear capacity control. The compressors have star-delta starting and cut-off valves on the discharge and suction.
- # Counter-flow "shell & tube" evaporator in air and water condensing versions.
- # Condensation exchanger with aluminum microchannels
- # High-performance fans to improve efficiency and reduce noise levels (EC version available as an option).
- # Up to three independent circuits, each equipped with electronic expansion valves.

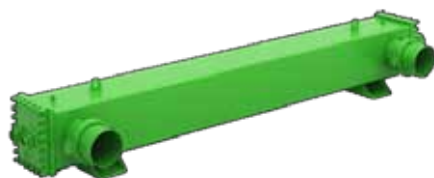
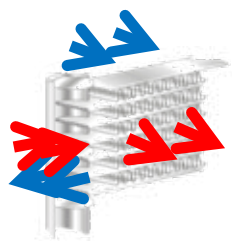

SILENCE MODES

- # "Low noise" version
 - Compressor compartment with sound insulation, made of polyurethane foam boards with two noise reduction options (air condensation version only).
- # High acoustic efficiency version :
 - Compressor compartment with sound insulation, consisting of polyurethane foam plates and polyethylene layers (all versions).
 - Lower fan rotation speeds and higher condensate exchanger power (air condensing version only).

CONTROL

- # Display-Programmer for communication via device with LCD display.
- # Touch display programmer installed on the machine with a 7" screen available as an accessory for all units
- # Remote control panel with 7" multi-color touch screen display-programmer available as an accessory for all units.



WATER CIRCUIT

- # Single or double pump, high or low pressure (inverter as an option).
- # Shut-off valve on the discharge and suction lines in each circuit.
- # Differential water pressure switch to prevent ice from forming in the pipes and to stop the system in the event of a pump failure or leak (alerts the user with a dedicated warning).
- # Antifreeze heating as an optional feature in the evaporator, tank, pumps and/or pipes
- # Low water temperature kit (as an option), to adjust system operation with water temperature from +5°C to -8°C.

Z_(A) A_(B) C_(C) 1100_(D) D_(E) X_(F) 1_(G) A_(H)

- (A) **Z** = eProcess
- (B) **A** = Air cooled unit - **B**= Air cooled unit with an inverter compressor - **C**= Air cooled unit all inverter compressors - **W** = Water cooled unit - **X** = Water cooled unit with an inverter compressor
- (C) **C** = Cooling-only units
- (D) **1100** = Approximate power in kW
- (E) **S** = Single circuit - **D** = Double circuit- **T** = Triple circuit
- (F) **A** = Refrigerant R134A - **J**= Refrigerant R513A - **X**= Refrigerant R1234ze - **H** = Refrigerant 515B
- (G) **1** = Revision number
- (H) **A** = Standard version - **HE** = High-efficiency version- **SSL** = Super "Low noise" version



Air cooled version

Cooling only units

eProcess - ZAC		0310D	0350D	0420D	0500D	0560D	0650D	0730D	0800D	0860D	0960D	1110D	1110D	1180T	1290T	1410T	1550T	
Nominal thermal performances - Cooling mode																		
Cooling capacity ⁽¹⁾		314.7	354.6	423.5	504.0	564.5	652.4	729.5	801.4	861.3	961.4	1032.3	1113.4	1179.3	1293.3	1409.0	1550.1	
Total absorbed power ⁽¹⁾		100.9	114.0	144.5	161.5	188.2	209.8	240.8	256.9	285.2	309.1	331.9	365.0	389.2	415.9	457.5	515.0	
EER ⁽¹⁾		3.1	3.1	2.9	3.1	3.0	3.1	3.0	3.1	3.02	3.11	3.11	3.05	3.03	3.11	3.08	3.01	
Comfort Application	Seasonal Energy Efficiency Ratio ⁽²⁾ SEER	4.68	4.61	4.58	4.68	4.57	4.67	4.60	4.64	4.60	4.64	4.63	4.59	4.64	4.66	4.68	4.67	
	Seasonal energy efficiency ⁽³⁾ η_{s,c}	%	184	181	180	184	180	184	181	183	181	183	182	181	183	184	184	
Acoustic data																		
Global sound power level - Standard unit ⁽⁴⁾		dB(A)	97	97	99	99	100	100	100	101	102	102	103	104	103	104	104	105
Electrical data																		
Maximum current		A	252	267	328	377	417	465	506	555	597	668	734	796	804	895	966	1095
Starting current		A	317	317	369	459	480	610	645	773	803	894	1075	1218	1022	1101	1204	1436
Refrigeration circuit																		
Number of circuits			2	2	2	2	2	2	2	2	2	2	2	2	3	3	3	3
Number of compressors			2	2	2	2	2	2	2	2	2	2	2	2	3	3	3	3
Total refrigerant load - R1234ze		kg	44	52	57	68	72	86	95	101	103	120	149	148	152	168	181	218
Evaporator																		
Nominal water flow rate ⁽¹⁾		m ³ /h	54.2	61.1	72.9	86.7	97.2	112.3	125.6	137.9	148.3	165.5	177.7	191.6	203.0	222.6	242.5	266.8
Nominal pressure drop ⁽¹⁾		kPa	25	35	52	35	42	55	38	36	46	35	39	31	36	37	45	54
Water connections		DN	125	125	125	125	125	125	125	150	150	150	200	200	200	200	200	200

(1) EUROVENT certified data, in accordance with standard EN 14511.
Cooling mode: Evaporator water temperature = 12/7°C | Outdoor air temperature = 35°C
 (2) Seasonal energy efficiency of low-temperature room air heating. In accordance with EU Regulation 2016/2281.
 (3) Temperature at which cooling capacity is reached equal to that indicated in point (1).
 (4) Sound power: in accordance with ISO 3744 and Eurovent 8/1.

Z^(A) A^(B) C^(C) 1100^(D) D^(E) X^(F) 1^(G) HE^(H)

- (A) **Z** = eProcess
 (B) **A** = Air cooled unit - **B**= Air cooled unit with an inverter compressor - **C**= Air cooled unit all inverter compressors -
W = Water cooled unit - **X** = Water cooled unit with an inverter compressor
 (C) **C** = Cooling-only units
 (D) **1100** = Approximate power in kW
 (E) **S** = Single circuit - **D** = Double circuit- **T** = Triple circuit
 (F) **A** = Refrigerant R134A - **J**= Refrigerant R513A - **X**= Refrigerant R1234ze - **H** = Refrigerant 515B
 (G) **1** = Revision number
 (H) **A** = Standard version - **HE** = High-efficiency version- **SSL** = Super "Low noise" version



Air cooled version

Cooling only units

eProcess - ZAC - HE		0330D	0370D	0440D	0520D	0580D	0670D	0760D	0830D	0890D	0980D	1060D	1150D	1210T	1330T	1430T	
Nominal thermal performances - Cooling mode																	
Cooling capacity ⁽¹⁾		335.6	372.6	441.6	520.5	584.6	675.5	759.5	829.4	893.5	980.4	1064.4	1149.3	1211.4	1332.2	1429.2	
Total absorbed power ⁽¹⁾		99.9	112.2	134.2	154.5	177.2	200.4	232.3	247.6	269.9	292.7	319.6	350.4	370.5	407.4	443.9	
EER ⁽¹⁾		3.4	3.3	3.3	3.4	3.3	3.4	3.3	3.4	3.31	3.35	3.33	3.28	3.27	3.27	3.22	
Comfort Application	Seasonal Energy Efficiency Ratio ⁽²⁾ SEER	4.83	4.81	4.73	4.83	4.79	4.83	4.79	4.82	4.76	4.78	4.80	4.78	4.84	4.84	4.85	
	Seasonal energy efficiency ⁽³⁾ η_{s,c}	%	190	189	186	190	189	190	189	190	187	188	189	188	191	191	
Acoustic data																	
Global sound power level - Standard unit ⁽⁴⁾		dB(A)	98.0	98.0	99.0	99.0	100.0	100.0	100.0	101.0	102.0	102.0	103.0	104.0	103.0	104.0	104.0
Electrical data																	
Maximum current		A	259.0	274.0	334.0	383.0	424.0	472.0	513.0	562.0	604.0	674.0	741.0	803.0	811.0	902.0	973.0
Starting current		A	324.0	324.0	376.0	465.0	486.0	617.0	652.0	780.0	810.0	901.0	1082.0	1225.0	1029.0	1108.0	1211.0
Refrigeration circuit																	
Number of circuits			2	2	2	2	2	2	2	2	2	2	2	2	3	3	3
Number of compressors			2	2	2	2	2	2	2	2	2	2	2	2	3	3	3
Total refrigerant load - R1234ze		kg	53	61	68	79	84	95	101	114	120	129	159	163	181	193	
Evaporator																	
Nominal water flow rate ⁽¹⁾		m ³ /h	57.8	64.2	76.0	89.6	100.6	116.3	130.7	142.8	153.8	168.7	183.2	197.8	208.5	229.3	246.0
Nominal pressure drop ⁽¹⁾		kPa	35	40	30	40	25	30	36	43	31	36	31	41	31	42	47
Water connections		DN	125	125	125	125	125	150	150	150	150	200	200	200	200	200	

(1) EUROVENT certified data, in accordance with standard EN 14511.

Cooling mode: Evaporator water temperature = 12/7°C | Outdoor air temperature = 35°C

(2) Seasonal energy efficiency of low-temperature room air heating. In accordance with EU Regulation 2016/2281.

(3) Temperature at which cooling capacity is reached equal to that indicated in point (1).

(4) Sound power: in accordance with ISO 3744 and Eurovent 8/1.

Z_(A) A_(B) C_(C) 1100_(D) D_(E) X_(F) 1_(G) SSL_(H)

- (A) **Z** = eProcess
- (B) **A** = Air cooled unit - **B**= Air cooled unit with an inverter compressor - **C**= Air cooled unit all inverter compressors - **W** = Water cooled unit - **X** = Water cooled unit with an inverter compressor
- (C) **C** = Cooling-only units
- (D) **1100** = Approximate power in kW
- (E) **S** = Single circuit - **D** = Double circuit- **T** = Triple circuit
- (F) **A** = Refrigerant R134A - **J**= Refrigerant R513A - **X**= Refrigerant R1234ze - **H** = Refrigerant 515B
- (G) **1** = Revision number
- (H) **A** = Standard version - **HE** = High-efficiency version- **SSL** = Super "Low noise" version



Air cooled version

Cooling only units

eProcess - ZAC - SSL		0330D	0370D	0440D	0520D	0580D	0670D	0760D	0830D	0890D	0980D	1060D	1150D	1210T	1330T	1430T	
Nominal thermal performances - Cooling mode																	
Cooling capacity ⁽¹⁾		327.7	361.6	428.6	499.5	567.0	655.5	737.0	796.4	857.5	941.4	1021.4	1103.3	1163.4	1279.3	1372.2	
Total absorbed power ⁽¹⁾		100.8	113.4	138.3	159.6	184.1	208.8	244.0	257.7	281.1	304.7	334.9	364.1	387.8	426.4	460.5	
EER ⁽¹⁾		3.3	3.2	3.1	3.1	3.1	3.1	3.0	3.1	3.05	3.09	3.05	3.03	3.00	3.00	2.98	
Comfort Application	Seasonal Energy Efficiency Ratio ⁽²⁾ SEER	4.79	4.78	4.68	4.77	4.73	4.77	4.72	4.74	4.69	4.71	4.72	4.71	4.77	4.77	4.79	
	Seasonal energy efficiency ⁽³⁾ η_{s,c}	%	189	188	184	188	186	188	186	187	185	185	186	185	188	188	189
Acoustic data																	
Global sound power level - Standard unit ⁽⁴⁾		dB(A)	89.0	89.0	90.0	90.0	91.0	91.0	91.0	93.0	94.0	94.0	95.0	95.0	95.0	96.0	96.0
Electrical data																	
Maximum current		A	259.0	274.0	334.0	383.0	424.0	472.0	513.0	562.0	604.0	674.0	741.0	803.0	811.0	902.0	973.0
Starting current		A	324.0	324.0	376.0	465.0	486.0	617.0	652.0	780.0	810.0	901.0	1082.0	1225.0	1029.0	1108.0	1211.0
Refrigeration circuit																	
Number of circuits			2	2	2	2	2	2	2	2	2	2	2	2	3	3	3
Number of compressors			2	2	2	2	2	2	2	2	2	2	2	2	3	3	3
Total refrigerant load - R1234ze		kg	53	61	68	79	84	95	101	114	120	129	159	163	181	193	
Evaporator																	
Nominal water flow rate ⁽¹⁾		m ³ /h	56.4	62.0	73.8	86.0	97.5	112.8	127.0	137.1	147.6	162.0	175.8	189.9	200.2	220.0	236.2
Nominal pressure drop ⁽¹⁾		kPa	33	38	28	37	23	28	34	40	29	33	29	38	29	39	43
Water connections		DN	125	125	125	125	125	150	150	150	150	200	200	200	200	200	200

(1) EUROVENT certified data, in accordance with standard EN 14511.
Cooling mode: Evaporator water temperature = 12/7°C | Outdoor air temperature = 35°C
 (2) Seasonal energy efficiency of low-temperature room air heating. In accordance with EU Regulation 2016/2281.
 (3) Temperature at which cooling capacity is reached equal to that indicated in point (1).
 (4) Sound power: in accordance with ISO 3744 and Eurovent 8/1.

Z_(A) B_(B) C_(C) 1100_(D) D_(E) X_(F) 1_(G) HE_(H)

- (A) Z = eProcess
- (B) A = Air cooled unit - B= Air cooled unit with an inverter compressor - C= Air cooled unit all inverter compressors - W = Water cooled unit - X = Water cooled unit with an inverter compressor
- (C) C = Cooling-only units
- (D) 1100 = Approximate power in kW
- (E) S = Single circuit - D = Double circuit- T = Triple circuit
- (F) A = Refrigerant R134A - J= Refrigerant R513A - X= Refrigerant R1234ze - H = Refrigerant 515B
- (G) 1 = Revision number
- (H) A = Standard version - HE = High-efficiency version- SSL = Super "Low noise" version



Air cooled version

Cooling only units

eProcess Plus - ZBC - HE		0390D	0430D	0510D	0600D	0700D	0810D	0900D	0990D	1100D	1170D	1260T	1380T	
Nominal thermal performances - Cooling mode														
Cooling capacity ⁽¹⁾		389.7	434.6	508.5	604.4	699.5	807.4	896.4	989.5	1101.4	1169.3	1259.3	1380.2	
Total absorbed power ⁽¹⁾		119.9	138.4	156.0	184.3	214.6	256.3	280.1	309.2	349.7	360.9	397.3	430.0	
EER ⁽¹⁾		3.3	3.1	3.3	3.3	3.3	3.2	3.2	3.2	3.15	3.24	3.17	3.21	
Comfort Application	Seasonal Energy Efficiency Ratio ⁽²⁾ SEER	5.00	4.95	5.02	5.03	4.99	5.01	5.02	5.00	5.01	5.02	5.04	5.10	
	Seasonal energy efficiency ⁽³⁾ η_{s,c}	%	197	195	198	198	197	197	198	197	197	198	201	
Acoustic data														
Global sound power level - Standard unit ⁽⁴⁾		dB(A)	101.0	102.0	102.0	103.0	103.0	104.0	105.0	105.0	105.0	106.0	106.0	
Electrical data														
Maximum current		A	304.0	350.0	377.0	445.0	486.0	605.0	702.0	723.0	826.0	864.0	903.0	992.0
Starting current		A	337.0	422.0	432.0	486.0	610.0	773.0	881.0	885.0	1079.0	1198.0	1119.0	
Refrigeration circuit														
Number of circuits			2	2	2	2	2	2	2	2	2	3	3	
Number of compressors			2	2	2	2	2	2	2	2	2	3	3	
Total refrigerant load - R1234ze		kg	57	61	79	92	101	113	119	128	158	181	191	
Evaporator														
Nominal water flow rate ⁽¹⁾		m ³ /h	67.1	74.8	87.5	104.1	120.4	139.0	154.3	170.3	189.5	201.2	216.7	237.5
Nominal pressure drop ⁽¹⁾		kPa	25	35	45	51	30	43	31	26	31	43	47	
Water connections		DN	125	125	125	150	150	150	150	150	200	200	200	

(1) EUROVENT certified data, in accordance with standard EN 14511.

Cooling mode: Evaporator water temperature = 12/7°C | Outdoor air temperature = 35°C

(2) Seasonal energy efficiency of low-temperature room air heating. In accordance with EU Regulation 2016/2281.

(3) Temperature at which cooling capacity is reached equal to that indicated in point (1).

(4) Sound power: in accordance with ISO 3744 and Eurovent 8/1.

Z_(A) B_(B) C_(C) 1100_(D) D_(E) X_(F) 1_(G) HE_(H)

- (A) **Z** = eProcess
- (B) **A** = Air cooled unit - **B**= Air cooled unit with an inverter compressor - **C**= Air cooled unit all inverter compressors - **W** = Water cooled unit - **X** = Water cooled unit with an inverter compressor
- (C) **C** = Cooling-only units
- (D) **1100** = Approximate power in kW
- (E) **S** = Single circuit - **D** = Double circuit- **T** = Triple circuit
- (F) **A** = Refrigerant R134A - **J**= Refrigerant R513A - **X**= Refrigerant R1234ze - **H** = Refrigerant 515B
- (G) **1** = Revision number
- (H) **A** = Standard version - **HE** = High-efficiency version- **SSL** = Super "Low noise" version



Air cooled version

Cooling only units

eProcess Plus - ZBC - SSL		0390D	0430D	0510D	0600D	0700D	0810D	0900D	0990D	1100D	1170D	1260T	1380T	
Nominal thermal performances - Cooling mode														
Cooling capacity ⁽¹⁾		377.7	421.6	493.5	580.0	678.5	783.4	869.5	959.5	1068.4	1122.3	1221.3	1325.2	
Total absorbed power ⁽¹⁾		124.7	143.4	161.8	190.8	225.4	266.5	293.8	324.2	363.4	374.1	414.0	450.7	
EER ⁽¹⁾		3.0	2.9	3.1	3.0	3.0	2.9	3.0	3.0	2.94	3.00	2.95	2.94	
Comfort Application	Seasonal Energy Efficiency Ratio ⁽²⁾ SEER	4.93	4.89	4.96	4.96	4.92	4.95	4.94	4.93	4.95	4.95	4.97	5.02	
	Seasonal energy efficiency ⁽³⁾ η_{s,c}	%	194	193	195	195	194	195	195	194	195	195	196	
Acoustic data														
Global sound power level - Standard unit ⁽⁴⁾		dB(A)	92.0	93.0	93.0	94.0	95.0	96.0	96.0	96.0	97.0	97.0	98.0	98.0
Electrical data														
Maximum current		A	304.0	350.0	377.0	445.0	486.0	605.0	702.0	723.0	826.0	864.0	903.0	992.0
Starting current		A	337.0	422.0	432.0	486.0	610.0	773.0	881.0	885.0	1079.0	1198.0	1072.0	1119.0
Refrigeration circuit														
Number of circuits			2	2	2	2	2	2	2	2	2	3	3	
Number of compressors			2	2	2	2	2	2	2	2	2	3	3	
Total refrigerant load - R1234ze		kg	57	61	79	92	101	113	119	128	158	181	191	
Evaporator														
Nominal water flow rate ⁽¹⁾		m ³ /h	65.0	72.6	85.0	99.9	116.8	135.0	149.6	165.1	183.9	193.2	210.2	228.1
Nominal pressure drop ⁽¹⁾		kPa	23	33	42	47	28	41	29	25	29	40	39	43
Water connections		DN	125	125	125	150	150	150	150	150	200	200	200	200

(1) EUROVENT certified data, in accordance with standard EN 14511.

Cooling mode: Evaporator water temperature = 12/7°C | Outdoor air temperature = 35°C

(2) Seasonal energy efficiency of low-temperature room air heating. In accordance with EU Regulation 2016/2281.

(3) Temperature at which cooling capacity is reached equal to that indicated in point (1).

(4) Sound power: in accordance with ISO 3744 and Eurovent 8/1.

Z^(A) C^(B) C^(C) 1100^(D) D^(E) X^(F) 1^(G) HE^(H)

- (A) Z = eProcess
- (B) A = Air cooled unit - B= Air cooled unit with an inverter compressor - C= Air cooled unit all inverter compressors - W = Water cooled unit - X = Water cooled unit with an inverter compressor
- (C) C = Cooling-only units
- (D) 1100 = Approximate power in kW
- (E) S = Single circuit - D = Double circuit- T = Triple circuit
- (F) A = Refrigerant R134A - J= Refrigerant R513A - X= Refrigerant R1234ze - H = Refrigerant 515B
- (G) 1 = Revision number
- (H) A = Standard version - HE = High-efficiency version- SSL = Super "Low noise" version



Air cooled version

Cooling only units

eProcess Premiere - ZCC - HE		0325S	0395S	0445D	0505D	0565D	0645D	0705D	0835D	0905D	1015D	1105D	1205D	1295T	1405T	
Nominal thermal performances - Cooling mode																
Cooling capacity ⁽¹⁾		322.6	391.6	443.6	507.5	567.6	642.0	707.5	832.5	900.0	1013.5	1105.3	1202.0	1294.3	1401.2	
Total absorbed power ⁽¹⁾		99.3	123.1	142.2	157.6	180.2	197.5	223.9	258.5	283.9	321.7	352.0	380.4	416.2	453.5	
EER ⁽¹⁾		3.3	3.2	3.1	3.2	3.2	3.3	3.2	3.2	3.17	3.15	3.14	3.16	3.11	3.09	
Comfort Application	Seasonal Energy Efficiency Ratio ⁽²⁾ SEER	5.09	5.12	5.25	5.31	5.21	5.32	5.30	5.33	5.26	5.21	5.32	5.31	5.33	5.27	
	Seasonal energy efficiency ⁽³⁾ η_{s,c}	%	201	202	207	209	205	210	209	210	207	205	210	209	210	
Acoustic data																
Global sound power level - Standard unit ⁽⁴⁾		dB(A)	101.0	102.0	103.0	103.0	103.0	104.0	104.0	105.0	106.0	106.0	106.0	106.0	107.0	107.0
Electrical data																
Maximum current		A	229.0	306.0	348.0	370.0	452.0	459.0	536.0	677.0	694.0	776.0	848.0	920.0	994.0	1076.0
Starting current		A	40.0	47.0	128.0	138.0	159.0	165.0	207.0	251.0	255.0	255.0	294.0	301.0	517.0	571.0
Refrigeration circuit																
Number of circuits			1	1	2	2	2	2	2	2	2	2	2	3	3	
Number of compressors			1	1	2	2	2	2	2	2	2	2	2	3	3	
Total refrigerant load - R1234ze		kg	46	58	61	79	85	99	111	120	131	130	158	189	192	
Evaporator																
Nominal water flow rate ⁽¹⁾		m ³ /h	55.6	67.4	76.4	87.4	97.7	110.4	121.8	143.3	155.0	174.4	190.2	206.9	222.7	241.1
Nominal pressure drop ⁽¹⁾		kPa	40	35	35	42	25	32	36	26	31	26	41	46	42	47
Water connections		DN	125	125	125	125	125	150	150	150	150	150	200	200	200	200

(1) EUROVENT certified data, in accordance with standard EN 14511.

Cooling mode: Evaporator water temperature = 12/7°C | Outdoor air temperature = 35°C

(2) Seasonal energy efficiency of low-temperature room air heating. In accordance with EU Regulation 2016/2281.

(3) Temperature at which cooling capacity is reached equal to that indicated in point (1).

(4) Sound power: in accordance with ISO 3744 and Eurovent 8/1.

Z^(A) C^(B) C^(C) 1100^(D) D^(E) X^(F) 1^(G) SSL^(H)

- (A) **Z** = eProcess
- (B) **A** = Air cooled unit - **B**= Air cooled unit with an inverter compressor - **C**= Air cooled unit all inverter compressors - **W** = Water cooled unit - **X** = Water cooled unit with an inverter compressor
- (C) **C** = Cooling-only units
- (D) **1100** = Approximate power in kW
- (E) **S** = Single circuit - **D** = Double circuit- **T** = Triple circuit
- (F) **A** = Refrigerant R134A - **J**= Refrigerant R513A - **X**= Refrigerant R1234ze - **H** = Refrigerant 515B
- (G) **1** = Revision number
- (H) **A** = Standard version - **HE** = High-efficiency version- **SSL** = Super "Low noise" version



Air cooled version

Cooling only units

eProcess Premiere - ZCC - SSL		0325S	0395S	0445D	0505D	0565D	0645D	0705D	0835D	0905D	1015D	1105D	1205D	1295T	1405T
Nominal thermal performances - Cooling mode															
Cooling capacity ⁽¹⁾		312.6	379.6	430.6	492.5	550.6	622.5	686.5	807.5	873.5	983.5	1072.3	1166.3	1255.3	1359.2
Total absorbed power ⁽¹⁾		103.2	128.2	148.0	163.6	187.3	206.8	232.7	268.3	295.1	334.5	366.0	395.4	432.9	470.3
EER ⁽¹⁾		3.0	3.0	2.9	3.0	2.9	3.0	3.0	3.0	2.96	2.94	2.93	2.95	2.90	2.89
Comfort Application	Seasonal Energy Efficiency Ratio ⁽²⁾ SEER	5.09	5.12	5.25	5.31	5.21	5.32	5.30	5.26	5.18	5.14	5.25	5.24	5.27	5.20
	Seasonal energy efficiency ⁽³⁾ η_{s,c}	%	201	202	207	209	205	210	209	207	204	203	207	207	208
Acoustic data															
Global sound power level - Standard unit ⁽⁴⁾	dB(A)	92.0	93.0	94.0	94.0	95.0	95.0	96.0	97.0	97.0	97.0	98.0	98.0	99.0	99.0
Electrical data															
Maximum current	A	229.0	306.0	348.0	370.0	452.0	459.0	536.0	677.0	694.0	776.0	848.0	920.0	994.0	1076.0
Starting current	A	40.0	47.0	128.0	138.0	159.0	165.0	207.0	251.0	255.0	255.0	294.0	301.0	517.0	571.0
Refrigeration circuit															
Number of circuits		1	1	2	2	2	2	2	2	2	2	2	2	3	3
Number of compressors		1	1	2	2	2	2	2	2	2	2	2	2	3	3
Total refrigerant load - R1234ze	kg	46	58	61	79	85	99	111	120	131	130	158	176	189	192
Evaporator															
Nominal water flow rate ⁽¹⁾	m ³ /h	53.8	65.4	74.1	84.8	94.8	107.2	118.2	139.0	150.3	169.2	184.6	200.7	216.0	233.9
Nominal pressure drop ⁽¹⁾	kPa	38	33	33	40	24	30	33	25	29	25	39	43	39	44
Water connections	DN	125	125	125	125	125	150	150	150	150	150	200	200	200	200

(1) EUROVENT certified data, in accordance with standard EN 14511.

Cooling mode: Evaporator water temperature = 12/7°C | Outdoor air temperature = 35°C

(2) Seasonal energy efficiency of low-temperature room air heating. In accordance with EU Regulation 2016/2281.

(3) Temperature at which cooling capacity is reached equal to that indicated in point (1).

(4) Sound power: in accordance with ISO 3744 and Eurovent 8/1.

Z^(A) X^(B) C^(C) 1100^(D) D^(E) X^(F) 1^(G) HE^(H)

- (A) Z = eProcess
- (B) A = Air cooled unit - B= Air cooled unit with an inverter compressor - C= Air cooled unit all inverter compressors - W = Water cooled unit - X = Water cooled unit with an inverter compressor
- (C) C = Cooling-only units
- (D) 1100 = Approximate power in kW
- (E) S = Single circuit - D = Double circuit- T = Triple circuit
- (F) A = Refrigerant R134A - J= Refrigerant R513A - X= Refrigerant R1234ze - H = Refrigerant 515B
- (G) 1 = Revision number
- (H) A = Standard version - HE = High-efficiency version- SSL = Super "Low noise" version



Water cooled version

Cooling only units

eProcess - ZXC		0280S	0340S	0430S	0520D	0580D	0650D	0710D	0800D	0890D	0970D	1090D	1220D
Nominal thermal performances - Cooling mode													
Cooling capacity ⁽¹⁾		285.6	346.6	434.5	524.4	584.4	648.4	719.4	800.4	897.3	974.3	1091.2	1217.2
Total absorbed power ⁽¹⁾		54.9	66.8	86.0	95.9	107.4	119.4	130.8	150.2	168.7	180.8	197.0	219.7
EER ⁽¹⁾		5.2	5.2	5.1	5.5	5.4	5.4	5.5	5.3	5.3	5.4	5.5	5.5
Comfort Application	Seasonal Energy Efficiency Ratio ⁽²⁾ SEER	7.64	7.62	7.58	7.42	7.56	7.63	7.37	7.41	7.24	7.25	7.33	7.31
	Seasonal energy efficiency ⁽³⁾ η_{s,c}	%	303	302	300	294	299	302	292	293	287	287	290
Acoustic data													
Global sound power level - Standard unit ⁽⁴⁾	dB(A)	97	99	101	98	98	100	100	102	103	103	102	103
Electrical data													
Maximum current	A	148	165	208	247	278	295	313	356	393	425	494	543
Starting current	A	20	20	20	373	462	479	483	526	673	794	863	1082
Refrigeration circuit													
Number of circuits		1	1	1	2	2	2	2	2	2	2	2	2
Number of compressors		1	1	1	2	2	2	2	2	2	2	2	2
Total refrigerant load - R1234ze		kg	84	94	103	112	112	171	171	179	179	233	233
Condensator													
Nominal water flow rate ⁽¹⁾		58.0	71.0	89.0	106.0	118.0	131.0	145.0	162.0	182.0	197.0	220.0	245.0
Nominal pressure drop ⁽¹⁾		17	17	17	37	45	40	38	39	40	42	38	46
Water connections		kg	100	125	125	1250	125	150	150	150	150	150	150
Evaporator													
Nominal water flow rate ⁽¹⁾		m ³ /h	49.2	59.7	74.8	90.3	100.6	111.6	124.0	137.8	154.5	167.7	209.5
Nominal pressure drop ⁽¹⁾		kPa	48	50	50	53	52	50	47	47	48	55	50
Water connections		DN	125	125	125	125	125	150	150	150	150	150	150

(1) EUROVENT certified data, in accordance with standard EN 14511.

Cooling mode: Evaporator water temperature = 12/7°C | Outdoor air temperature = 35°C

(2) Seasonal energy efficiency of low-temperature room air heating. In accordance with EU Regulation 2016/2281.

(3) Temperature at which cooling capacity is reached equal to that indicated in point (1).

(4) Sound power: in accordance with ISO 3744 and Eurovent 8/1.



Air cooled version

Cooling only units

eProcess - ZAC		0310D	0350D	0420D	0500D	0560D	0650D	0730D	0800D	0860D	0960D	1030D	1110D	1180T	1290T	1410T	1550T
A	mm	3800	3800	3800	4900	4900	6000	6000	7160	7160	8260	9360	9360	9360	10530	11630	12730
B		2260	2260	2260	2260	2260	2260	2260	2260	2260	2260	2260	2260	2260	2260	2260	2260
C		2480	2480	2480	2480	2480	2480	2480	2480	2480	2480	2480	2480	2480	2480	2480	2480
Weight of standard units																	
Transport weight	kg	3000	3090	3810	4210	4340	5110	5620	6230	6350	6820	7450	7690	9360	9900	10410	11090



Air cooled version

Cooling only units

eProcess - ZAC - HE/SSL		0330D	0370D	0440D	0520D	0580D	0670D	0760D	0830D	0890D	0980D	1060D	1150D	1210T	1330T	1430T	
A	mm	4900	4900	4900	6000	6000	7160	7160	8260	8260	9360	10460	10460	10530	11630	12730	
B		2260	2260	2260	2260	2260	2260	2260	2260	2260	2260	2260	2260	2260	2260	2260	
C		2480	2480	2480	2480	2480	2480	2480	2480	2480	2480	2480	2480	2480	2480	2480	
Weight of standard units																	
Transport weight HE version	kg	3370	3450	4200	4550	4680	5680	6130	6590	6850	7220	7840	7950	9780	10180	10560	
Transport weight SSL version	kg	3645	3725	4525	4875	5005	6110	6560	7020	7280	7650	8270	8380	10325	10725	11105	



Air cooled version

Cooling only units

eProcess - ZBC - HE/SSL		0390D	0430D	0510D	0600D	0700D	0810D	0900D	0990D	1100D	1170D	1260T	1380T	
A	mm	4990	4990	6090	7250	7250	8350	9450	9450	10550	11650	11630	12730	
B		2260	2260	2260	2260	2260	2260	2260	2260	2260	2260	2260	2260	
C		2480	2480	2480	2480	2480	2480	2480	2480	2480	2480	2480	2480	
Weight of standard units														
Transport weight HE version	kg	3900	4240	4640	5210	5830	6260	7070	7350	7700	8070	9760	10450	
Transport weight SSL version	kg	4225	4565	4965	5640	6260	6690	7500	7780	8130	8500	10305	10995	



Air cooled version

Cooling only units

eProcess - ZCC - HE/SSL		0325S	0395S	0445D	0505D	0565D	0645D	0705D	0835D	0905D	1015D	1105D	1205D	1295T	1405T	
A	mm	4900	4900	4900	6000	6000	7160	7160	9450	9450	9450	10550	11650	12730	12730	
B		2260	2260	2260	2260	2260	2260	2260	2260	2260	2260	2260	2260	2260	2260	
C		2480	2480	2480	2480	2480	2480	2480	2480	2480	2480	2480	2480	2480	2480	
Weight of standard units																
Transport weight HE version	kg	2850	3690	4170	4610	4660	5210	5660	6360	6500	7170	7450	7720	9420	9830	
Transport weight SSL version	kg	3030	3870	4495	4935	4985	5640	6090	6790	6930	7600	7880	8150	9965	10375	

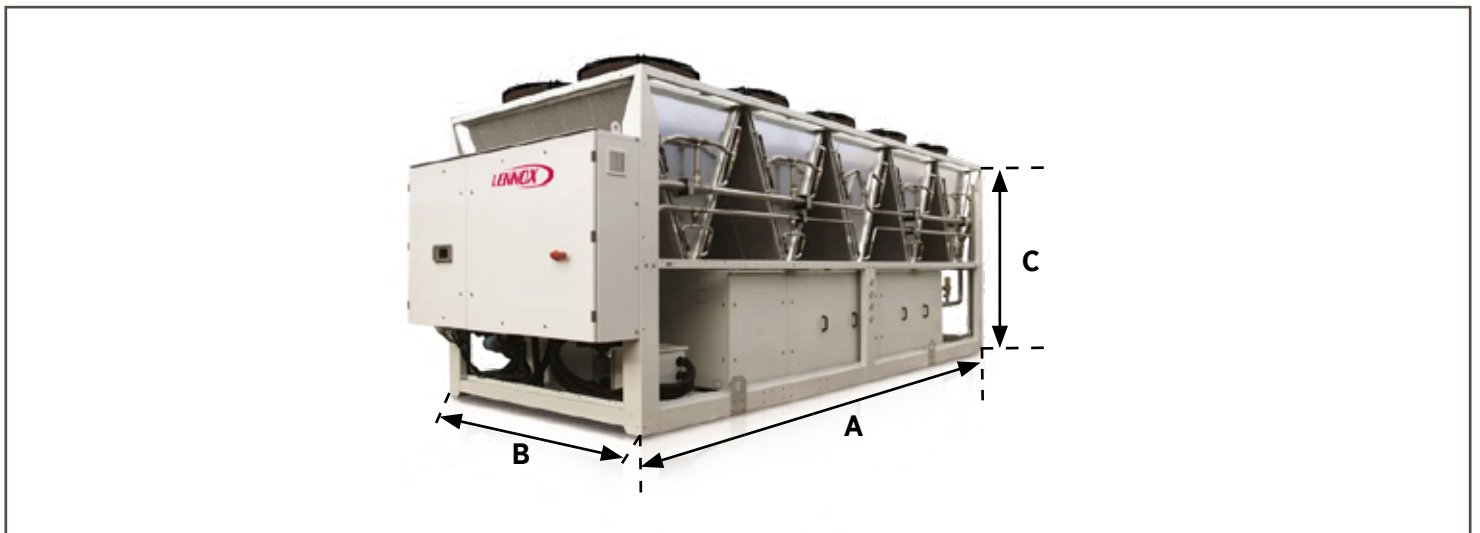



Water cooled version

Cooling only units

eProcess - ZXC		1280	1340	1430	2520	2580	2650	2710	2800	2890	2970	21090	21220
A	mm	3859	3859	3859	4008	4008	3990	4329	4407	4407	4407	4501	4586
B		1531	1531	1591	1676	1676	1676	1676	1814	1844	1844	1964	2009
C		1830	1830	1830	1910	1910	2040	2040	2040	2040	2040	2080	2080
Weight of standard units													
Transport weight	kg	2335	2440	2535	4095	4190	4735	5205	5355	5620	5765	6790	7135

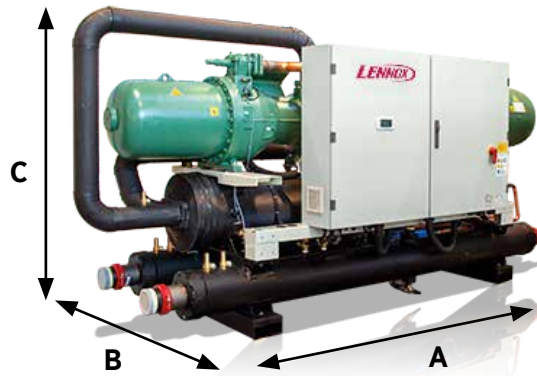

Z_(A) A_(B) C_(C) 1100_(D) D_(E) A_(F) 1_(G) A_(H)

- (A) **Z** = eProcess
- (B) **A** = Air cooled unit - **B**= Air cooled unit with an inverter compressor - **C**= Air cooled unit all inverter compressors -
W = Water cooled unit - **X** = Water cooled unit with an inverter compressor
- (C) **C** = Cooling-only units
- (D) **1100** = Approximate power in kW
- (E) **S** = Single circuit - **D** = Double circuit- **T** = Triple circuit
- (F) **A** = Refrigerant R134A - **J**= Refrigerant R513A - **X**= Refrigerant R1234ze - **H** = Refrigerant 515B
- (G) **1** = Revision number
- (H) **A** = Standard version - **HE** = High-efficiency version- **SSL** = Super "Low noise" version



Air cooled version

Cooling only units

eProcess - ZAC		0335D	0365D	0405D	0465D	0515D	0565D	0645D	0705D	0755D	0805D	1550T
Nominal thermal performances - Cooling mode												
Cooling capacity ⁽¹⁾		334.6	371.6	408.5	467.0	522.3	567.4	653.4	711.4	761.4	803.4	869.3
Total absorbed power ⁽¹⁾		108.3	124.7	139.4	152.1	175.9	195.7	215.6	239.5	258.1	264.3	293.7
EER ⁽¹⁾		3.1	3.0	2.9	3.1	3.0	2.9	3.0	3.0	2.95	3.04	2.96
Comfort Application	Seasonal Energy Efficiency Ratio ⁽²⁾ SEER	4.68	4.63	4.60	4.67	4.62	4.58	4.66	4.62	4.61	4.63	4.60
	Seasonal energy efficiency ⁽³⁾ η_{s,c}	%	184	182	181	184	182	180	183	182	181	181
Acoustic data												
Global sound power level - Standard unit ⁽⁴⁾		dB(A)	97	97	98	98	98	98	99	99	100	100
Electrical data												
Maximum current		A	224	252	280	286	353	396	452	452	452	507
Starting current		A	246	287	331	338	399	479	507	507	507	637
Refrigeration circuit												
Number of circuits			2	2	2	2	2	2	2	2	2	2
Number of compressors			2	2	2	2	2	2	2	2	2	2
Total refrigerant load - R1234A		kg	41	41	45	64	61	62	79	82	85	99
Evaporator												
Nominal water flow rate ⁽¹⁾		m ³ /h	57.6	64.0	70.3	80.3	90.0	97.7	112.5	122.5	131.1	138.3
Nominal pressure drop ⁽¹⁾		kPa	41	50	48	54	75	55	56	44	50	39
Water connections		DN	125	125	125	125	125	150	150	150	150	200

(1) EUROVENT certified data, in accordance with standard EN 14511.

Cooling mode: Evaporator water temperature = 12/7°C | Outdoor air temperature = 35°C

(2) Seasonal energy efficiency of low-temperature room air heating. In accordance with EU Regulation 2016/2281.

(3) Temperature at which cooling capacity is reached equal to that indicated in point (1).

(4) Sound power: in accordance with ISO 3744 and Eurovent 8/1.

Z^(A) A^(B) C^(C) 1100^(D) D^(E) A^(F) 1^(G) A^(H)

- (A) **Z** = eProcess
 (B) **A** = Air cooled unit - **B**= Air cooled unit with an inverter compressor - **C**= Air cooled unit all inverter compressors -
W = Water cooled unit - **X** = Water cooled unit with an inverter compressor
 (C) **C** = Cooling-only units
 (D) **1100** = Approximate power in kW
 (E) **S** = Single circuit - **D** = Double circuit- **T** = Triple circuit
 (F) **A** = Refrigerant R134A - **J**= Refrigerant R513A - **X**= Refrigerant R1234ze - **H** = Refrigerant 515B
 (G) **1** = Revision number
 (H) **A** = Standard version - **HE** = High-efficiency version- **SSL** = Super "Low noise" version



Air cooled version

Cooling only units

eProcess - ZAC		0935D	0995D	1075D	1115D	1275D	1405D	1505D	1605T	1705T	1805T	1955T	
Nominal thermal performances - Cooling mode													
Cooling capacity ⁽¹⁾		948.3	999.2	1086.3	1126.2	1293.0	1406.1	1507.2	1605.1	1700.2	1806.1	1953.1	
Total absorbed power ⁽¹⁾		310.9	334.2	349.3	375.4	414.4	465.6	504.1	507.9	541.5	573.4	666.6	
EER ⁽¹⁾		3.05	2.99	3.11	3.00	3.12	3.02	2.99	3.16	3.14	3.15	2.93	
Comfort Application	Seasonal Energy Efficiency Ratio ⁽²⁾ SEER	4.64	4.61	4.63	4.63	4.66	4.60	4.60	4.67	4.63	4.65	4.60	
	Seasonal energy efficiency ⁽³⁾ η_{s,c}	%	183	181	182	182	183	181	181	184	182	181	
Acoustic data													
Global sound power level - Standard unit ⁽⁴⁾		dB(A)	101	101	102	102	103	104	104	104	105	106	
Electrical data													
Maximum current		A	610	658	703	742	749	842	910	903	951	1046	1167
Starting current		A	805	832	903	925	932	1141	1250	1098	1146	1246	1462
Refrigeration circuit													
Number of circuits			2	2	2	2	2	2	2	3	3	3	3
Number of compressors			2	2	2	2	2	2	2	3	3	3	3
Total refrigerant load - R1234A		kg	110	110	123	123	135	192	196	212	217	229	252
Evaporator													
Nominal water flow rate ⁽¹⁾		m ³ /h	163.2	172.0	187.0	193.8	222.6	242.0	259.4	276.2	292.6	310.8	336.1
Nominal pressure drop ⁽¹⁾		kPa	56	61	50	54	72	68	44	60	42	49	61
Water connections		DN	200	200	200	200	200	200	200	200	200	200	200

(1) EUROVENT certified data, in accordance with standard EN 14511.

Cooling mode: Evaporator water temperature = 12/7°C | Outdoor air temperature = 35°C

(2) Seasonal energy efficiency of low-temperature room air heating. In accordance with EU Regulation 2016/2281.

(3) Temperature at which cooling capacity is reached equal to that indicated in point (1).

(4) Sound power: in accordance with ISO 3744 and Eurovent 8/1.

Z_(A) A_(B) C_(C) 1100_(D) D_(E) A_(F) 1_(G) HE_(H)

- (A) **Z** = eProcess
- (B) **A** = Air cooled unit - **B**= Air cooled unit with an inverter compressor - **C**= Air cooled unit all inverter compressors -
W = Water cooled unit - **X** = Unidade de condensação a ar com um compressor inverter
- (C) **C** = Cooling-only units
- (D) **1100** = Approximate power in kW
- (E) **S** = Single circuit - **D** = Double circuit- **T** = Triple circuit
- (F) **A** = Refrigerant R134A - **J**= Refrigerant R513A - **X**= Refrigerant R1234ze - **H** = Refrigerant 515B
- (G) **1** = Revision number
- (H) **A** = Standard version - **HE** = High-efficiency version- **SSL** = Super "Low noise" version



Air cooled version

Cooling only units

eProcess - ZAC - HE		0345D	0385D	0425D	0475D	0525D	0585D	0655D	0715D	0765D	0815D
Nominal thermal performances - Cooling mode											
Cooling capacity ⁽¹⁾		344.6	384.6	429.6	480.5	534.4	585.4	667.4	722.4	775.3	824.4
Total absorbed power ⁽¹⁾		103.2	116.5	131.4	144.7	161.9	178.5	199.2	217.6	234.9	246.8
EER ⁽¹⁾		3.3	3.3	3.3	3.3	3.3	3.3	3.4	3.3	3.30	3.34
Comfort Application	Seasonal Energy Efficiency Ratio ⁽²⁾ SEER	4.83	4.77	4.76	4.82	4.76	4.76	4.82	4.81	4.80	4.78
	Seasonal energy efficiency ⁽³⁾ η_{s,c}	%	190	188	187	190	187	187	190	189	188
Acoustic data											
Global sound power level - Standard unit ⁽⁴⁾	dB(A)	98.0	98.0	98.0	98.0	98.0	99.0	99.0	99.0	100.0	100.0
Electrical data											
Maximum current	A	231.0	259.0	286.0	293.0	360.0	403.0	459.0	459.0	459.0	514.0
Starting current	A	253.0	294.0	338.0	344.0	405.0	485.0	513.0	513.0	513.0	644.0
Refrigeration circuit											
Number of circuits		2	2	2	2	2	2	2	2	2	2
Number of compressors		2	2	2	2	2	2	2	2	2	2
Total refrigerant load - R1234A	kg	53	53	58	74	73	73	93	97	101	108
Evaporator											
Nominal water flow rate ⁽¹⁾	m ³ /h	59.3	66.2	74.0	82.7	92.0	100.8	114.9	124.4	133.5	141.9
Nominal pressure drop ⁽¹⁾	kPa	36	44	33	44	53	61	42	51	58	42
Water connections	DN	125	125	125	125	150	150	150	150	150	200

(1) EUROVENT certified data, in accordance with standard EN 14511.

Cooling mode: Evaporator water temperature = 12/7°C | Outdoor air temperature = 35°C

(2) Seasonal energy efficiency of low-temperature room air heating. In accordance with EU Regulation 2016/2281.

(3) Temperature at which cooling capacity is reached equal to that indicated in point (1).

(4) Sound power: in accordance with ISO 3744 and Eurovent 8/1.

Z^(A) A^(B) C^(C) 1100^(D) D^(E) A^(F) 1^(G) HE^(H)

- (A) **Z** = eProcess
- (B) **A** = Air cooled unit - **B**= Air cooled unit with an inverter compressor - **C**= Air cooled unit all inverter compressors -
W = Water cooled unit - **X** = Water cooled unit with an inverter compressor
- (C) **C** = Cooling-only units
- (D) **1100** = Approximate power in kW
- (E) **S** = Single circuit - **D** = Double circuit- **T** = Triple circuit
- (F) **A** = Refrigerant R134A - **J**= Refrigerant R513A - **X**= Refrigerant R1234ze - **H** = Refrigerant 515B
- (G) **1** = Revision number
- (H) **A** = Standard version - **HE** = High-efficiency version- **SSL** = Super "Low noise" version



Air cooled version

Cooling only units

eProcess - ZAC - HE		0885D	0955D	1025D	1105D	1175D	1335D	1455D	1565D	1655T	1715T
Nominal thermal performances - Cooling mode											
Cooling capacity ⁽¹⁾		891.3	968.3	1034.3	1121.2	1181.2	1333.1	1450.2	1564.1	1655.1	1714.2
Total absorbed power ⁽¹⁾		270.1	287.3	312.5	335.7	362.3	407.7	454.6	495.0	497.0	522.6
EER ⁽¹⁾		3.30	3.37	3.31	3.34	3.26	3.27	3.19	3.16	3.33	3.28
Comfort Application	Seasonal Energy Efficiency Ratio ⁽²⁾ SEER	4.74	4.77	4.77	4.82	4.75	4.78	4.79	4.76	4.83	4.75
	Seasonal energy efficiency ⁽³⁾ η_{s,c}	% 187	188	188	190	187	188	189	187	190	187
Acoustic data											
Global sound power level - Standard unit ⁽⁴⁾	dB(A)	101.0	101.0	101.0	102.0	102.0	102.0	103.0	104.0	104.0	104.0
Electrical data											
Maximum current	A	562.0	616.0	664.0	710.0	749.0	756.0	849.0	917.0	911.0	959.0
Starting current	A	684.0	812.0	839.0	910.0	932.0	939.0	1148.0	1257.0	1107.0	1155.0
Refrigeration circuit											
Number of circuits		2	2	2	2	2	2	2	2	3	3
Number of compressors		2	2	2	2	2	2	2	2	3	3
Total refrigerant load - R1234A		kg 110	123	123	140	140	152	209	213	224	231
Evaporator											
Nominal water flow rate ⁽¹⁾		m ³ /h 153.4	166.7	178.0	193.0	203.3	229.5	249.6	269.2	284.8	295.0
Nominal pressure drop ⁽¹⁾		kPa 51	42	46	53	57	71	40	53	61	44
Water connections		DN 200	200	200	200	200	200	200	200	200	200

(1) EUROVENT certified data, in accordance with standard EN 14511.

Cooling mode: Evaporator water temperature = 12/7°C | Outdoor air temperature = 35°C

(2) Seasonal energy efficiency of low-temperature room air heating. In accordance with EU Regulation 2016/2281.

(3) Temperature at which cooling capacity is reached equal to that indicated in point (1).

(4) Sound power: in accordance with ISO 3744 and Eurovent 8/1.

Z_(A) A_(B) C_(C) 1100_(D) D_(E) A_(F) 1_(G) SSL_(H)

- (A) **Z** = eProcess
- (B) **A** = Air cooled unit - **B**= Air cooled unit with an inverter compressor - **C**= Air cooled unit all inverter compressors -
W = Water cooled unit - **X** = Water cooled unit with an inverter compressor
- (C) **C** = Cooling-only units
- (D) **1100** = Approximate power in kW
- (E) **S** = Single circuit - **D** = Double circuit- **T** = Triple circuit
- (F) **A** = Refrigerant R134A - **J**= Refrigerant R513A - **X**= Refrigerant R1234ze - **H** = Refrigerant 515B
- (G) **1** = Revision number
- (H) **A** = Standard version - **HE** = High-efficiency version- **SSL** = Super "Low noise" version



Air cooled version

Cooling only units

eProcess - ZAC - SSL		0345D	0385D	0425D	0475D	0525D	0585D	0655D	0715D	0765D	0815D
Nominal thermal performances - Cooling mode											
Cooling capacity ⁽¹⁾		334.7	373.6	412.6	476.5	514.0	562.4	642.0	701.4	752.3	791.4
Total absorbed power ⁽¹⁾		103.0	117.5	133.1	149.8	165.3	186.2	206.4	233.8	254.2	256.1
EER ⁽¹⁾		3.3	3.2	3.1	3.2	3.1	3.0	3.1	3.0	2.96	3.09
Comfort Application	Seasonal Energy Efficiency Ratio ⁽²⁾ SEER	4.78	4.68	4.65	4.75	4.71	4.66	4.73	4.72	4.69	4.67
	Seasonal energy efficiency ⁽³⁾ η_{s,c}	% 188	184	183	187	185	183	186	186	185	184
Acoustic data											
Global sound power level - Standard unit ⁽⁴⁾	dB(A)	89.0	89.0	89.0	89.0	89.0	90.0	90.0	90.0	91.0	92.0
Electrical data											
Maximum current	A	231.0	259.0	286.0	293.0	360.0	403.0	459.0	459.0	459.0	514.0
Starting current	A	253.0	294.0	338.0	344.0	405.0	485.0	513.0	513.0	513.0	644.0
Refrigeration circuit											
Number of circuits		2	2	2	2	2	2	2	2	2	2
Number of compressors		2	2	2	2	2	2	2	2	2	2
Total refrigerant load - R1234A	kg	53	53	58	74	73	73	93	97	101	108
Evaporator											
Nominal water flow rate ⁽¹⁾	m ³ /h	57.6	64.0	71.0	82.0	88.4	96.8	110.0	120.7	130.0	136.2
Nominal pressure drop ⁽¹⁾	kPa	34	42	30	43	49	56	39	48	55	39
Water connections	DN	125	125	125	125	150	150	150	150	150	200

(1) EUROVENT certified data, in accordance with standard EN 14511.

Cooling mode: Evaporator water temperature = 12/7°C | Outdoor air temperature = 35°C

(2) Seasonal energy efficiency of low-temperature room air heating. In accordance with EU Regulation 2016/2281.

(3) Temperature at which cooling capacity is reached equal to that indicated in point (1).

(4) Sound power: in accordance with ISO 3744 and Eurovent 8/1.

Z^(A) A^(B) C^(C) 1100^(D) D^(E) A^(F) 1^(G) SSL^(H)

- (A) **Z** = eProcess
 (B) **A** = Air cooled unit - **B**= Air cooled unit with an inverter compressor - **C**= Air cooled unit all inverter compressors -
W = Water cooled unit - **X** = Water cooled unit with an inverter compressor
 (C) **C** = Cooling-only units
 (D) **1100** = Approximate power in kW
 (E) **S** = Single circuit - **D** = Double circuit- **T** = Triple circuit
 (F) **A** = Refrigerant R134A - **J**= Refrigerant R513A - **X**= Refrigerant R1234ze - **H** = Refrigerant 515B
 (G) **1** = Revision number
 (H) **A** = Standard version - **HE** = High-efficiency version- **SSL** = Super "Low noise" version



Air cooled version

Cooling only units

eProcess - ZAC - SSL		0885D	0955D	1025D	1105D	1175D	1335D	1455D	1565D	1655T	1715T
Nominal thermal performances - Cooling mode											
Cooling capacity ⁽¹⁾		851.3	930.4	1003.3	1077.3	1128.2	1287.1	1407.3	1502.2	1605.1	1663.2
Total absorbed power ⁽¹⁾		283.8	301.1	331.1	350.9	381.1	431.9	469.1	514.5	517.8	541.8
EER ⁽¹⁾		3.00	3.09	3.03	3.07	2.96	2.98	3.00	2.92	3.10	3.07
Comfort Application	Seasonal Energy Efficiency Ratio ⁽²⁾ SEER	4.66	4.66	4.64	4.69	4.66	4.66	4.71	4.66	4.75	4.65
	Seasonal energy efficiency ⁽³⁾ η_{s,c}	%	183	183	183	185	183	183	185	183	187
Acoustic data											
Global sound power level - Standard unit ⁽⁴⁾	dB(A)	93.0	93.0	93.0	93.0	94.0	94.0	95.0	96.0	97.0	97.0
Electrical data											
Maximum current	A	562.0	616.0	664.0	710.0	749.0	756.0	849.0	917.0	911.0	959.0
Starting current	A	684.0	812.0	839.0	910.0	932.0	939.0	1148.0	1257.0	1107.0	1155.0
Refrigeration circuit											
Number of circuits		2	2	2	2	2	2	2	2	3	3
Number of compressors		2	2	2	2	2	2	2	2	3	3
Total refrigerant load - R1234A	kg	110	123	123	140	140	152	209	213	224	231
Evaporator											
Nominal water flow rate ⁽¹⁾	m ³ /h	146.5	160.1	172.7	185.4	194.2	222.0	242.2	258.5	276.2	286.2
Nominal pressure drop ⁽¹⁾	kPa	47	39	43	49	52	66	38	49	57	41
Water connections	DN	200	200	200	200	200	200	200	200	200	200

(1) EUROVENT certified data, in accordance with standard EN 14511.

Cooling mode: Evaporator water temperature = 12/7°C | Outdoor air temperature = 35°C

(2) Seasonal energy efficiency of low-temperature room air heating. In accordance with EU Regulation 2016/2281.

(3) Temperature at which cooling capacity is reached equal to that indicated in point (1).

(4) Sound power: in accordance with ISO 3744 and Eurovent 8/1.

Z^(A) B^(B) C^(C) 1100^(D) D^(E) A^(F) 1^(G) HE^(H)

- (A) **Z** = eProcess
- (B) **A** = Air cooled unit - **B**= Air cooled unit with an inverter compressor - **C**= Air cooled unit all inverter compressors - **W** = Water cooled unit - **X** = Water cooled unit with an inverter compressor
- (C) **C** = Cooling-only units
- (D) **1100** = Approximate power in kW
- (E) **S** = Single circuit - **D** = Double circuit- **T** = Triple circuit
- (F) **A** = Refrigerant R134A - **J**= Refrigerant R513A - **X**= Refrigerant R1234ze - **H** = Refrigerant 515B
- (G) **1** = Revision number
- (H) **A** = Standard version - **HE** = High-efficiency version- **SSL** = Super "Low noise" version



Air cooled version

Cooling only units

eProcess Plus - ZBC - HE		0560D	0600D	0670D	0710D	0770D	0860D	0930D	0980D	1080D	1160D	1310D	1500D	1600D	1700T	1840T	
Nominal thermal performances - Cooling mode																	
Cooling capacity ⁽¹⁾		569.4	610.5	680.4	722.4	776.4	873.3	945.3	991.3	1094.2	1178.2	1325.1	1510.1	1600.1	1699.2	1839.1	
Total absorbed power ⁽¹⁾		176.8	186.7	209.4	223.7	236.7	268.7	283.9	300.4	335.6	375.2	409.0	482.5	493.9	522.8	583.8	
EER ⁽¹⁾		3.2	3.3	3.3	3.2	3.3	3.3	3.3	3.3	3.26	3.14	3.24	3.13	3.24	3.25	3.15	
Comfort Application	Seasonal Energy Efficiency Ratio ⁽²⁾ SEER	5.08	5.01	5.03	5.01	5.01	5.04	5.02	5.00	5.01	5.00	5.01	5.00	4.98	5.05	5.01	
	Seasonal energy efficiency ⁽³⁾ η_{s,c}	%	200	197	198	197	197	199	198	197	197	197	197	196	199	197	
Acoustic data																	
Global sound power level - Standard unit ⁽⁴⁾		dB(A)	101.0	102.0	102.0	102.0	103.0	103.0	104.0	104.0	104.0	104.0	105.0	106.0	106.0	106.0	106.0
Electrical data																	
Maximum current		A	399.0	406.0	406.0	431.0	507.0	507.0	537.0	658.0	658.0	795.0	802.0	916.0	959.0	994.0	1092.0
Starting current		A	438.0	445.0	445.0	472.0	597.0	597.0	632.0	793.0	793.0	906.0	913.0	1107.0	1228.0	1129.0	1178.0
Refrigeration circuit																	
Number of circuits			2	2	2	2	2	2	2	2	2	2	2	2	3	3	
Number of compressors			2	2	2	2	2	2	2	2	2	2	2	2	3	3	
Total refrigerant load - R1234A		kg	78	93	100	100	107	114	128	133	138	140	160	217	218	231	234
Evaporator																	
Nominal water flow rate ⁽¹⁾		m ³ /h	98.0	105.1	117.1	124.4	133.6	150.3	162.7	170.6	188.3	202.8	228.1	259.9	275.4	292.4	316.5
Nominal pressure drop ⁽¹⁾		kPa	61	36	46	50	42	53	42	45	55	60	76	53	60	44	56
Water connections		DN	150	150	150	150	200	200	200	200	200	200	200	200	200	200	200

(1) EUROVENT certified data, in accordance with standard EN 14511.

Cooling mode: Evaporator water temperature = 12/7°C | Outdoor air temperature = 35°C

(2) Seasonal energy efficiency of low-temperature room air heating. In accordance with EU Regulation 2016/2281.

(3) Temperature at which cooling capacity is reached equal to that indicated in point (1).

(4) Sound power: in accordance with ISO 3744 and Eurovent 8/1.

Z^(A) B^(B) C^(C) 1100^(D) D^(E) A^(F) 1^(G) SSL^(H)

- (A) Z = eProcess
- (B) A = Air cooled unit - B= Air cooled unit with an inverter compressor - C= Air cooled unit all inverter compressors - W = Water cooled unit - X = Water cooled unit with an inverter compressor
- (C) C = Cooling-only units
- (D) 1100 = Approximate power in kW
- (E) S = Single circuit - D = Double circuit- T = Triple circuit
- (F) A = Refrigerant R134A - J= Refrigerant R513A - X= Refrigerant R1234ze - H = Refrigerant 515B
- (G) 1 = Revision number
- (H) A = Standard version - HE = High-efficiency version- SSL = Super "Low noise" version



Air cooled version

Cooling only units

eProcess Plus - ZBC - SSL		0560D	0600D	0670D	0710D	0770D	0860D	0930D	0980D	1080D	1160D	1310D	1500D	1600D	1700T	1840T	
Nominal thermal performances - Cooling mode																	
Cooling capacity ⁽¹⁾		550.4	586.5	660.4	697.4	749.0	843.3	912.4	957.3	1056.3	1131.2	1272.1	1459.2	1552.1	1648.2	1784.1	
Total absorbed power ⁽¹⁾		183.5	189.8	220.9	237.2	247.2	285.9	301.1	314.9	354.5	386.1	431.2	493.0	513.9	542.2	604.8	
EER ⁽¹⁾		3.0	3.1	3.0	2.9	3.0	3.0	3.0	3.0	2.98	2.93	2.95	2.96	3.02	3.04	2.95	
Comfort Application	Seasonal Energy Efficiency Ratio ⁽²⁾ SEER	4.98	4.91	4.91	4.91	4.91	4.93	4.90	4.90	4.93	4.88	4.91	4.90	4.87	4.96	4.91	
	Seasonal energy efficiency ⁽³⁾ η_{s,c}	%	196	193	193	193	193	194	193	193	194	192	193	193	192	195	193
Acoustic data																	
Global sound power level - Standard unit ⁽⁴⁾		dB(A)	93.0	93.0	93.0	93.0	94.0	95.0	95.0	95.0	96.0	96.0	97.0	98.0	99.0	99.0	99.0
Electrical data																	
Maximum current		A	399.0	406.0	406.0	431.0	507.0	507.0	537.0	658.0	658.0	795.0	802.0	916.0	959.0	994.0	1092.0
Starting current		A	438.0	445.0	445.0	472.0	597.0	597.0	632.0	793.0	793.0	906.0	913.0	1107.0	1228.0	1129.0	1178.0
Refrigeration circuit																	
Number of circuits			2	2	2	2	2	2	2	2	2	2	2	2	3	3	
Number of compressors			2	2	2	2	2	2	2	2	2	2	2	2	3	3	
Total refrigerant load - R1234A		kg	78	93	100	100	107	114	128	133	138	140	160	217	218	231	234
Evaporator																	
Nominal water flow rate ⁽¹⁾		m ³ /h	94.8	101.0	113.7	120.1	129.0	145.2	157.0	164.8	181.8	194.7	219.0	251.1	267.1	283.6	307.0
Nominal pressure drop ⁽¹⁾		kPa	57	33	43	47	39	49	39	42	51	55	70	49	56	41	53
Water connections		DN	150	150	150	150	200	200	200	200	200	200	200	200	200	200	200

(1) EUROVENT certified data, in accordance with standard EN 14511.

Cooling mode: Evaporator water temperature = 12/7°C | Outdoor air temperature = 35°C

(2) Seasonal energy efficiency of low-temperature room air heating. In accordance with EU Regulation 2016/2281.

(3) Temperature at which cooling capacity is reached equal to that indicated in point (1).

(4) Sound power: in accordance with ISO 3744 and Eurovent 8/1.

Z_(A) C_(B) C_(C) 1100_(D) D_(E) A_(F) 1_(G) HE_(H)

- (A) **Z** = eProcess
- (B) **A** = Air cooled unit - **B**= Air cooled unit with an inverter compressor - **C**= Air cooled unit all inverter compressors - **W** = Water cooled unit - **X** = Water cooled unit with an inverter compressor
- (C) **C** = Cooling-only units
- (D) **1100** = Approximate power in kW
- (E) **S** = Single circuit - **D** = Double circuit- **T** = Triple circuit
- (F) **A** = Refrigerant R134A - **J**= Refrigerant R513A - **X**= Refrigerant R1234ze - **H** = Refrigerant 515B
- (G) **1** = Revision number
- (H) **A** = Standard version - **HE** = High-efficiency version- **SSL** = Super "Low noise" version



Air cooled version

Cooling only units

eProcess Premiere - ZCC - HE		0565D	0615D	0685D	0775D	0845D	0945D	1005D	1195D	1365D	1495D	1615D	1715T	1865T	
Nominal thermal performances - Cooling mode															
Cooling capacity ⁽¹⁾		570.4	619.5	689.4	782.4	856.3	955.0	1015.3	1195.2	1364.0	1504.1	1616.1	1715.2	1864.1	
Total absorbed power ⁽¹⁾		177.7	193.0	215.4	242.2	266.8	295.7	322.3	384.3	430.3	480.5	518.0	546.2	617.3	
EER ⁽¹⁾		3.2	3.2	3.2	3.2	3.2	3.2	3.2	3.1	3.17	3.13	3.12	3.14	3.02	
Comfort Application	Seasonal Energy Efficiency Ratio ⁽²⁾ SEER	5.33	5.27	5.32	5.30	5.28	5.28	5.31	5.23	5.32	5.24	5.18	5.24	5.17	
	Seasonal energy efficiency ⁽³⁾ η_{s,c}	%	210	208	210	209	208	208	209	206	210	207	204	204	
Acoustic data															
Global sound power level - Standard unit ⁽⁴⁾		dB(A)	102.0	103.0	103.0	104.0	104.0	105.0	105.0	105.0	106.0	106.0	107.0	108.0	108.0
Electrical data															
Maximum current		A	396.0	402.0	402.0	500.0	500.0	645.0	645.0	743.0	848.0	919.0	992.0	1164.0	1164.0
Starting current		A	305.0	312.0	312.0	387.0	387.0	499.0	499.0	597.0	653.0	724.0	331.0	627.0	627.0
Refrigeration circuit															
Number of circuits			2	2	2	2	2	2	2	2	2	2	3	3	
Number of compressors			2	2	2	2	2	2	2	2	2	2	3	3	
Total refrigerant load - R1234A		kg	78	93	100	107	114	133	139	180	196	217	218	236	
Evaporator															
Nominal water flow rate ⁽¹⁾		m ³ /h	98.2	106.6	118.7	134.7	147.4	164.4	174.8	205.7	234.8	258.9	278.1	295.2	320.8
Nominal pressure drop ⁽¹⁾		kPa	62	38	47	43	51	43	50	54	39	53	64	45	58
Water connections		DN	150	150	150	200	200	200	200	200	200	200	200	200	200

(1) EUROVENT certified data, in accordance with standard EN 14511.

Cooling mode: Evaporator water temperature = 12/7°C | Outdoor air temperature = 35°C

(2) Seasonal energy efficiency of low-temperature room air heating. In accordance with EU Regulation 2016/2281.

(3) Temperature at which cooling capacity is reached equal to that indicated in point (1).

(4) Sound power: in accordance with ISO 3744 and Eurovent 8/1.

Z^(A) C^(B) C^(C) 1100^(D) D^(E) A^(F) 1^(G) SSL^(H)

- (A) **Z** = eProcess
- (B) **A** = Air cooled unit - **B**= Air cooled unit with an inverter compressor - **C**= Air cooled unit all inverter compressors - **W** = Water cooled unit - **X** = Water cooled unit with an inverter compressor
- (C) **C** = Cooling-only units
- (D) **1100** = Approximate power in kW
- (E) **S** = Single circuit - **D** = Double circuit- **T** = Triple circuit
- (F) **A** = Refrigerant R134A - **J**= Refrigerant R513A - **X**= Refrigerant R1234ze - **H** = Refrigerant 515B
- (G) **1** = Revision number
- (H) **A** = Standard version - **HE** = High-efficiency version- **SSL** = Super "Low noise" version



Air cooled version

Cooling only units

eProcess Premiere - ZCC - SSL		0565D	0615D	0685D	0775D	0845D	0945D	1005D	1195D	1365D	1495D	1615D	1715T	1865T	
Nominal thermal performances - Cooling mode															
Cooling capacity ⁽¹⁾		552.4	604.5	673.4	759.4	833.3	927.4	989.3	1158.2	1321.3	1458.2	1567.1	1664.2	1808.1	
Total absorbed power ⁽¹⁾		184.1	195.6	226.0	251.5	283.4	307.1	334.2	403.6	447.9	494.3	536.7	568.0	641.2	
EER ⁽¹⁾		3.0	3.1	3.0	3.0	2.9	3.0	3.0	2.9	2.95	2.95	2.92	2.93	2.82	
Comfort Application	Seasonal Energy Efficiency Ratio ⁽²⁾ SEER	5.23	5.18	5.21	5.23	5.17	5.19	5.20	5.14	5.23	5.15	5.11	5.17	5.08	
	Seasonal energy efficiency ⁽³⁾ η_{s,c}	%	206	204	205	206	204	205	205	203	206	203	201	204	200
Acoustic data															
Global sound power level - Standard unit ⁽⁴⁾		dB(A)	94.00	94.00	94.00	95.00	96.00	96.00	97.0	97.0	98.0	98.0	100.0	101.0	101.0
Electrical data															
Maximum current		A	396.0	402.0	402.0	500.0	500.0	645.0	645.0	743.0	848.0	919.0	992.0	1164.0	1164.0
Starting current		A	305.0	312.0	312.0	387.0	387.0	499.0	499.0	597.0	653.0	724.0	331.0	627.0	627.0
Refrigeration circuit															
Number of circuits			2	2	2	2	2	2	2	2	2	2	2	3	3
Number of compressors			2	2	2	2	2	2	2	2	2	2	2	3	3
Total refrigerant load - R1234A		kg	78	93	100	107	114	133	139	180	196	217	218	230	236
Evaporator															
Nominal water flow rate ⁽¹⁾		m ³ /h	95.1	104.1	115.9	130.7	143.4	159.6	170.3	199.4	227.4	251.0	269.7	286.4	311.2
Nominal pressure drop ⁽¹⁾		kPa	58	36	45	41	48	41	47	51	37	50	60	42	55
Water connections		DN	150	150	150	200	200	200	200	200	200	200	200	200	200

(1) EUROVENT certified data, in accordance with standard EN 14511.

Cooling mode: Evaporator water temperature = 12/7°C | Outdoor air temperature = 35°C

(2) Seasonal energy efficiency of low-temperature room air heating. In accordance with EU Regulation 2016/2281.

(3) Temperature at which cooling capacity is reached equal to that indicated in point (1).

(4) Sound power: in accordance with ISO 3744 and Eurovent 8/1.



Air cooled version

Cooling only units

eProcess - ZAC		0335D	0365D	0405D	0465D	0515D	0565D	0645D	0705D	0755D	0805D	1550T
A	mm	3800	3800	3800	4900	4900	8260	9360	9360	9360	10530	12730
B		2260	2260	2260	2260	2260	2260	2260	2260	2260	2260	2260
C		2480	2480	2480	2480	2480	2480	2480	2480	2480	2480	2480
Weight of standard units												
Transport weight	kg	3000	3090	3810	4210	4340	6820	7450	7690	9360	9900	11090

eProcess - ZAC		0935D	0995D	1075D	1115D	1275D	1405D	1505D	1605T	1705T	1805T	1955T
A	mm	8260	8260	9360	9360	10460	11560	11560	11630	11630	12730	12730
B		2260	2260	2260	2260	2260	2260	2260	2260	2260	2260	2260
C		2480	2480	2480	2480	2480	2480	2480	2480	2480	2480	2480
Weight of standard units												
Transport weight	kg	6021	6081	6516	6536	6916	8247	8588	9813	9910	10345	10622



Air cooled version

Cooling only units

eProcess - ZAC - HE/SSL		0345D	0385D	0425D	0475D	0525D	0585D	0655D	0715D	0765D	0815D	
A	mm	4840	4840	4840	6000	6000	6000	7160	7160	7160	8260	
B		2260	2260	2260	2260	2260	2260	2260	2260	2260	2260	
C		2480	2480	2480	2480	2480	2480	2480	2480	2480	2480	
Weight of standard units												
Transport weight HE version	kg	2991	2996	3030	3395	4094	4124	4647	4684	4704	5516	
Transport weight SSL version	kg	5946	6416	6481	6848	6868	7273	8968	9304	10128	10220	

eProcess - ZAC - HE/SSL		0345D	0385D	0425D	0475D	0525D	0585D	0655D	0715D	0765D	0815D	
A	mm	8260	9360	9360	10460	10460	11560	12730	12730	12730	12730	
B		2260	2260	2260	2260	2260	2260	2260	2260	2260	2260	
C		2480	2480	2480	2480	2480	2480	2480	2480	2480	2480	
Weight of standard units												
Transport weight HE version	kg	5946	6416	6481	6848	6868	7273	8968	9304	10128	10220	
Transport weight SSL version	kg	6346	6816	6881	7248	7268	7673	9388	9724	10668	10760	



Air cooled version

Cooling only units

eProcess - ZBC - HE/SSL		0560D	0600D	0670D	0710D	0770D	0860D	0930D	0980D	1080D	1160D	1310D	1500D	1600D	1700T	1840T
A		6090	7250	7250	7250	8350	8350	9450	10550	10550	10550	11650	12810	11650	12730	12730
B		2260	2260	2260	2260	2260	2260	2260	2260	2260	2260	2260	2260	2260	2260	2260
C		2480	2480	2480	2480	2480	2480	2480	2480	2480	2480	2480	2480	2480	2480	2480
Weight of standard units																
Transport weight HE version	kg	4314	4727	4797	4807	5641	5741	6146	6416	6526	6868	7248	9134	8386	9840	10277
Transport weight SSL version	kg	4694	5127	5197	5207	6041	6141	6546	6816	6926	7268	7648	9574	8826	10380	10817



Air cooled version

Cooling only units

eProcess - ZCC - HE/SSL		0565D	0615D	0685D	0775D	0845D	0945D	1005D	1195D	1365D	1495D	1615D	1715T	1865T
A		6090	7250	7250	8350	8350	10550	10550	10550	11650	12810	11650	12730	12730
B	mm	2260	2260	2260	2260	2260	2260	2260	2260	2260	2260	2260	2260	2260
C		2480	2480	2480	2480	2480	2480	2480	2480	2480	2480	2480	2480	2480
Weight of standard units														
Transport weight HE version	kg	4144	4607	4707	5021	5141	5766	5876	6977	7763	8734	8036	9640	9687
Transport weight SSL version	kg	4524	5007	5107	5421	5541	6166	10550	7397	8183	9174	8476	10180	10227

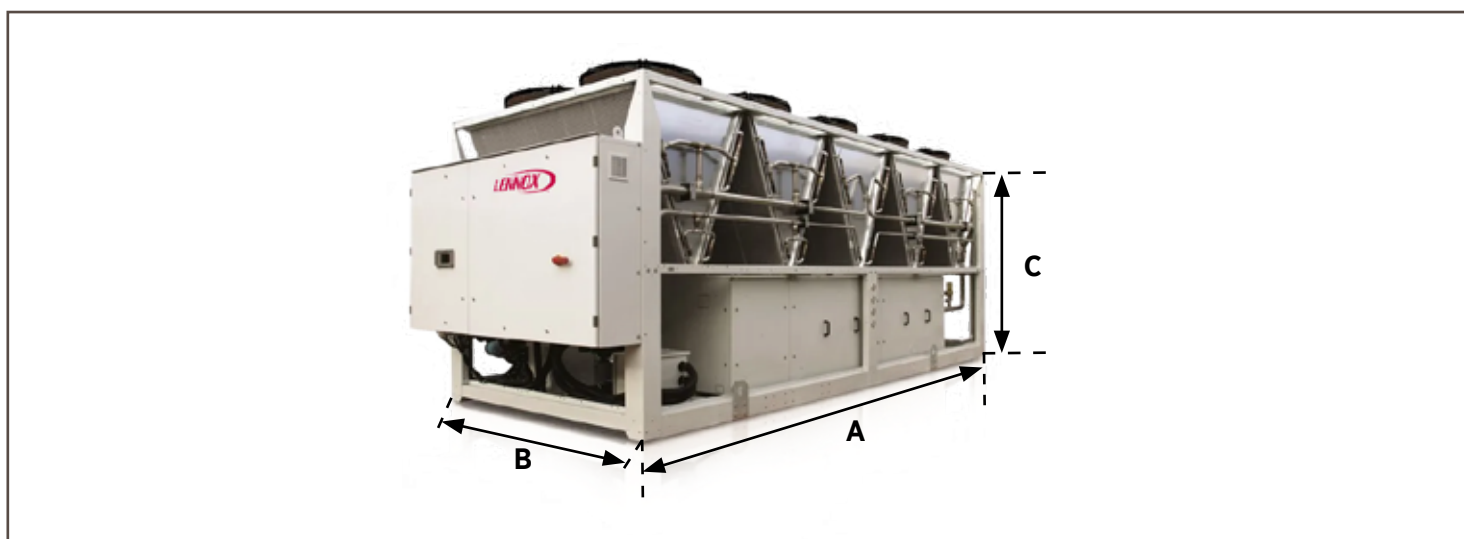

Z_(A) A_(B) C_(C) 1100_(D) D_(E) J_(F) 1_(G) A_(H)

- (A) **Z** = eProcess
- (B) **A** = Air cooled unit - **B**= Air cooled unit with an inverter compressor - **C**= Air cooled unit all inverter compressors -
W = Water cooled unit - **X** = Water cooled unit with an inverter compressor
- (C) **C** = Cooling-only units
- (D) **1100** = Approximate power in kW
- (E) **S** = Single circuit - **D** = Double circuit- **T** = Triple circuit
- (F) **A** = Refrigerant R134A - **J**= Refrigerant R513A - **X**= Refrigerant R1234ze - **H** = Refrigerant 515B
- (G) **1** = Revision number
- (H) **A** = Standard version - **HE** = High-efficiency version- **SSL** = Super "Low noise" version



Air cooled version

Cooling only units

eProcess - ZAC		0335D	0365D	0405D	0465D	0515D	0565D	0645D	0705D	0755D	0805D	0865D
Nominal thermal performances - Cooling mode												
Cooling capacity ⁽¹⁾		333.6	370.6	406.5	465.0	520.4	565.4	650.4	708.4	758.4	799.4	865.3
Total absorbed power ⁽¹⁾		111.2	127.4	142.6	155.0	180.1	199.1	220.5	244.3	264.3	270.1	300.5
EER ⁽¹⁾		3.0	2.9	2.9	3.0	2.9	2.8	3.0	2.9	2.87	2.96	2.88
Comfort Application	Seasonal Energy Efficiency Ratio ⁽²⁾ SEER	4.62	4.59	4.57	4.64	4.58	4.55	4.62	4.59	4.57	4.58	4.57
	Seasonal energy efficiency ⁽³⁾ η_{s,c}	%	182	181	180	183	180	179	182	181	180	180
Acoustic data												
Global sound power level - Standard unit ⁽⁴⁾		dB(A)	97	98	98	98	98	99	99	100	100	101
Electrical data												
Maximum current		A	232	261	290	297	365	407	462	462	462	520
Starting current		A	249	291	335	342	655	487	513	513	513	644
Refrigeration circuit												
Number of circuits			2	2	2	2	2	2	2	2	2	2
Number of compressors			2	2	2	2	2	2	2	2	2	2
Total refrigerant load - R513A		kg	39	39	43	60	58	58	75	77	80	93
Evaporator												
Nominal water flow rate ⁽¹⁾		m ³ /h	57.4	63.8	70.0	80.0	89.6	97.4	112.0	121.9	130.5	137.6
Nominal pressure drop ⁽¹⁾		kPa	41	50	48	54	74	55	55	44	50	39
Water connections		DN	125	125	125	125	125	150	150	150	150	200

(1) EUROVENT certified data, in accordance with standard EN 14511.

Cooling mode: Evaporator water temperature = 12/7°C | Outdoor air temperature = 35°C

(2) Seasonal energy efficiency of low-temperature room air heating. In accordance with EU Regulation 2016/2281.

(3) Temperature at which cooling capacity is reached equal to that indicated in point (1).

(4) Sound power: in accordance with ISO 3744 and Eurovent 8/1.

Z^(A) A^(B) C^(C) 1100^(D) D^(E) J^(F) 1^(G) A^(H)

- (A) **Z** = eProcess
 (B) **A** = Air cooled unit - **B**= Air cooled unit with an inverter compressor - **C**= Air cooled unit all inverter compressors -
W = Water cooled unit - **X** = Water cooled unit with an inverter compressor
 (C) **C** = Cooling-only units
 (D) **1100** = Approximate power in kW
 (E) **S** = Single circuit - **D** = Double circuit- **T** = Triple circuit
 (F) **A** = Refrigerant R134A - **J**= Refrigerant R513A - **X**= Refrigerant R1234ze - **H** = Refrigerant 515B
 (G) **1** = Revision number
 (H) **A** = Standard version - **HE** = High-efficiency version- **SSL** = Super "Low noise" version



Air cooled version

Cooling only units

eProcess - ZAC		0935D	0995D	1075D	1115D	1275D	1405D	1505D	1605T	1705T	1805T	1955T	
Nominal thermal performances - Cooling mode													
Cooling capacity ⁽¹⁾		944.3	994.2	1081.3	1121.2	1287.0	1399.1	1503.2	1599.1	1694.2	1799.1	1946.1	
Total absorbed power ⁽¹⁾		317.9	341.6	356.9	382.7	423.4	475.9	514.8	522.6	557.3	589.9	680.5	
EER ⁽¹⁾		2.97	2.91	3.03	2.93	3.04	2.94	2.92	3.06	3.04	3.05	2.86	
Comfort Application	Seasonal Energy Efficiency Ratio ⁽²⁾ SEER	4.60	4.58	4.59	4.59	4.62	4.56	4.58	4.63	4.59	4.61	4.57	
	Seasonal energy efficiency ⁽³⁾ η_{s,c}	%	181	180	181	181	182	179	180	182	181	180	
Acoustic data													
Global sound power level - Standard unit ⁽⁴⁾		dB(A)	101	101	102	102	103	104	104	104	105	106	
Electrical data													
Maximum current		A	625	672	718	758	765	844	920	926	973	1068	1184
Starting current		A	813	840	910	934	941	1119	1257	1114	1161	1260	1479
Refrigeration circuit													
Number of circuits			2	2	2	2	2	2	3	3	3	3	
Number of compressors			2	2	2	2	2	2	3	3	3	3	
Total refrigerant load - R513A		kg	104	104	116	116	128	182	185	197	202	235	
Evaporator													
Nominal water flow rate ⁽¹⁾		m ³ /h	162.5	171.1	186.1	193.0	221.5	240.8	258.7	275.2	291.5	309.6	334.9
Nominal pressure drop ⁽¹⁾		kPa	56	60	50	54	71	67	44	60	42	49	61
Water connections		DN	200	200	200	200	200	200	200	200	200	200	

(1) EUROVENT certified data, in accordance with standard EN 14511.

Cooling mode: Evaporator water temperature = 12/7°C | Outdoor air temperature = 35°C

(2) Seasonal energy efficiency of low-temperature room air heating. In accordance with EU Regulation 2016/2281.

(3) Temperature at which cooling capacity is reached equal to that indicated in point (1).

(4) Sound power: in accordance with ISO 3744 and Eurovent 8/1.

Z_(A) A_(B) C_(C) 1100_(D) D_(E) J_(F) 1_(G) HE_(H)

- (A) **Z** = eProcess
- (B) **A** = Air cooled unit - **B**= Air cooled unit with an inverter compressor - **C**= Air cooled unit all inverter compressors -
W = Water cooled unit - **X** = Water cooled unit with an inverter compressor
- (C) **C** = Cooling-only units
- (D) **1100** = Approximate power in kW
- (E) **S** = Single circuit - **D** = Double circuit- **T** = Triple circuit
- (F) **A** = Refrigerant R134A - **J**= Refrigerant R513A - **X**= Refrigerant R1234ze - **H** = Refrigerant 515B
- (G) **1** = Revision number
- (H) **A** = Standard version - **HE** = High-efficiency version- **SSL** = Super "Low noise" version



Air cooled version

Cooling only units

eProcess - ZAC HE		0345D	0385D	0425D	0475D	0525D	0585D	0655D	0715D	0765D	0815D
Nominal thermal performances - Cooling mode											
Cooling capacity ⁽¹⁾		343.6	383.6	427.6	478.5	532.4	583.4	664.4	719.4	772.3	820.4
Total absorbed power ⁽¹⁾		106.0	119.5	134.0	147.7	166.4	182.9	203.2	222.7	239.8	251.7
EER ⁽¹⁾		3.2	3.2	3.2	3.2	3.2	3.2	3.3	3.2	3.22	3.26
Comfort Application	Seasonal Energy Efficiency Ratio ⁽²⁾ SEER	4.80	4.72	4.71	4.77	4.71	4.72	4.77	4.76	4.76	4.74
	Seasonal energy efficiency ⁽³⁾ η_{s,c}	% 189	186	185	188	185	186	188	187	187	187
Acoustic data											
Global sound power level - Standard unit ⁽⁴⁾	dB(A)	98.0	98.0	98.0	98.0	98.0	99.0	99.0	99.0	100.0	100.0
Electrical data											
Maximum current	A	239.0	268.0	297.0	304.0	371.0	414.0	469.0	469.0	469.0	527.0
Starting current	A	256.0	298.0	342.0	349.0	661.0	494.0	520.0	520.0	520.0	650.0
Refrigeration circuit											
Number of circuits		2	2	2	2	2	2	2	2	2	2
Number of compressors		2	2	2	2	2	2	2	2	2	2
Total refrigerant load - R513A	kg	50	50	55	70	69	69	88	92	96	103
Evaporator											
Nominal water flow rate ⁽¹⁾	m ³ /h	59.2	66.0	73.6	82.4	91.7	100.4	114.4	123.8	133.0	141.2
Nominal pressure drop ⁽¹⁾	kPa	36	44	33	44	53	61	42	51	58	42
Water connections	DN	125	125	125	125	150	150	150	150	150	200

(1) EUROVENT certified data, in accordance with standard EN 14511.

Cooling mode: Evaporator water temperature = 12/7°C | Outdoor air temperature = 35°C

(2) Seasonal energy efficiency of low-temperature room air heating. In accordance with EU Regulation 2016/2281.

(3) Temperature at which cooling capacity is reached equal to that indicated in point (1).

(4) Sound power: in accordance with ISO 3744 and Eurovent 8/1.

Z^(A) A^(B) C^(C) 1100^(D) D^(E) J^(F) 1^(G) HE^(H)

- (A) **Z** = eProcess
 (B) **A** = Air cooled unit - **B**= Air cooled unit with an inverter compressor - **C**= Air cooled unit all inverter compressors -
W = Water cooled unit - **X** = Water cooled unit with an inverter compressor
 (C) **C** = Cooling-only units
 (D) **1100** = Approximate power in kW
 (E) **S** = Single circuit - **D** = Double circuit- **T** = Triple circuit
 (F) **A** = Refrigerant R134A - **J**= Refrigerant R513A - **X**= Refrigerant R1234ze - **H** = Refrigerant 515B
 (G) **1** = Revision number
 (H) **A** = Standard version - **HE** = High-efficiency version- **SSL** = Super "Low noise" version



Air cooled version

Cooling only units

eProcess - ZAC HE		0885D	0955D	1025D	1105D	1175D	1335D	1455D	1565D	1655T	1715T
Nominal thermal performances - Cooling mode											
Cooling capacity ⁽¹⁾		887.3	964.3	1029.3	1116.2	1176.2	1327.1	1443.2	1557.1	1649.1	1705.2
Total absorbed power ⁽¹⁾		276.4	293.1	319.7	343.4	371.0	417.3	462.6	505.6	509.0	534.5
EER ⁽¹⁾		3.21	3.29	3.22	3.25	3.17	3.18	3.12	3.08	3.24	3.19
Comfort Application	Seasonal Energy Efficiency Ratio ⁽²⁾ SEER	4.70	4.73	4.72	4.77	4.71	4.74	4.74	4.72	4.78	4.69
	Seasonal energy efficiency ⁽³⁾ η_{s,c}	%	185	186	186	188	185	187	187	186	188
Acoustic data											
Global sound power level - Standard unit ⁽⁴⁾	dB(A)	101.0	101.0	101.0	102.0	102.0	102.0	103.0	104.0	104.0	104.0
Electrical data											
Maximum current	A	578.0	631.0	678.0	725.0	765.0	772.0	851.0	927.0	934.0	981.0
Starting current	A	692.0	819.0	846.0	917.0	941.0	948.0	1126.0	1264.0	1122.0	1169.0
Refrigeration circuit											
Number of circuits		2	2	2	2	2	2	2	2	3	3
Number of compressors		2	2	2	2	2	2	2	2	3	3
Total refrigerant load - R513A	kg	104	116	116	133	133	144	197	201	209	215
Evaporator											
Nominal water flow rate ⁽¹⁾	m ³ /h	152.7	166.0	177.2	192.0	202.4	228.4	248.4	268.0	283.8	293.4
Nominal pressure drop ⁽¹⁾	kPa	51	42	46	53	57	70	40	53	61	44
Water connections	DN	200	200	200	200	200	200	200	200	200	200

(1) EUROVENT certified data, in accordance with standard EN 14511.

Cooling mode: Evaporator water temperature = 12/7°C | Outdoor air temperature = 35°C

(2) Seasonal energy efficiency of low-temperature room air heating. In accordance with EU Regulation 2016/2281.

(3) Temperature at which cooling capacity is reached equal to that indicated in point (1).

(4) Sound power: in accordance with ISO 3744 and Eurovent 8/1.

Z_(A) A_(B) C_(C) 1100_(D) D_(E) J_(F) 1_(G) SSL_(H)

- (A) **Z** = eProcess
- (B) **A** = Air cooled unit - **B**= Air cooled unit with an inverter compressor - **C**= Air cooled unit all inverter compressors -
W = Water cooled unit - **X** = Water cooled unit with an inverter compressor
- (C) **C** = Cooling-only units
- (D) **1100** = Approximate power in kW
- (E) **S** = Single circuit - **D** = Double circuit- **T** = Triple circuit
- (F) **A** = Refrigerant R134A - **J**= Refrigerant R513A - **X**= Refrigerant R1234ze - **H** = Refrigerant 515B
- (G) **1** = Revision number
- (H) **A** = Standard version - **HE** = High-efficiency version- **SSL** = Super "Low noise" version



Air cooled version

Cooling only units

eProcess - ZAC SSL		0345D	0385D	0425D	0475D	0525D	0585D	0655D	0715D	0765D	0815D
Nominal thermal performances - Cooling mode											
Cooling capacity ⁽¹⁾		333.7	372.6	410.6	474.5	511.5	560.4	638.5	698.4	749.3	788.4
Total absorbed power ⁽¹⁾		105.9	120.2	136.0	152.6	168.8	190.6	210.7	238.4	260.2	261.9
EER ⁽¹⁾		3.2	3.1	3.0	3.1	3.0	2.9	3.0	2.9	2.88	3.01
Comfort Application	Seasonal Energy Efficiency Ratio ⁽²⁾ SEER	4.73	4.63	4.61	4.72	4.68	4.61	4.69	4.67	4.66	4.63
	Seasonal energy efficiency ⁽³⁾ η_{s,c}	%	186	182	181	186	184	181	185	184	183
Acoustic data											
Global sound power level - Standard unit ⁽⁴⁾	dB(A)	89	89	89	89	89	90	90	90	91	92
Electrical data											
Maximum current	A	239	268	297	304	371	414	469	469	469	527
Starting current	A	256	298	342	349	661	494	520	520	520	650
Refrigeration circuit											
Number of circuits		2	2	2	2	2	2	2	2	2	2
Number of compressors		2	2	2	2	2	2	2	2	2	2
Total refrigerant load - R513A		kg	50	50	55	70	69	69	88	92	103
Evaporator											
Nominal water flow rate ⁽¹⁾		m ³ /h	57.4	64.2	70.7	81.7	88.1	96.5	109.9	120.2	129.0
Nominal pressure drop ⁽¹⁾		kPa	34	42	30	43	49	56	39	48	55
Water connections		DN	125	125	125	125	150	150	150	150	200

(1) EUROVENT certified data, in accordance with standard EN 14511.

Cooling mode: Evaporator water temperature = 12/7°C | Outdoor air temperature = 35°C

(2) Seasonal energy efficiency of low-temperature room air heating. In accordance with EU Regulation 2016/2281.

(3) Temperature at which cooling capacity is reached equal to that indicated in point (1).

(4) Sound power: in accordance with ISO 3744 and Eurovent 8/1.

Z^(A) A^(B) C^(C) 1100^(D) D^(E) J^(F) 1^(G) SSL^(H)

- (A) **Z** = eProcess
 (B) **A** = Air cooled unit - **B**= Air cooled unit with an inverter compressor - **C**= Air cooled unit all inverter compressors -
W = Water cooled unit - **X** = Water cooled unit with an inverter compressor
 (C) **C** = Cooling-only units
 (D) **1100** = Approximate power in kW
 (E) **S** = Single circuit - **D** = Double circuit- **T** = Triple circuit
 (F) **A** = Refrigerant R134A - **J**= Refrigerant R513A - **X**= Refrigerant R1234ze - **H** = Refrigerant 515B
 (G) **1** = Revision number
 (H) **A** = Standard version - **HE** = High-efficiency version- **SSL** = Super "Low noise" version



Air cooled version

Cooling only units

eProcess - ZAC SSL		0885D	0955D	1025D	1105D	1175D	1335D	1455D	1565D	1655T	1715T
Nominal thermal performances - Cooling mode											
Cooling capacity ⁽¹⁾		847.3	926.4	998.3	1072.3	1123.2	1281.1	1400.3	1501.2	1596.1	1650.2
Total absorbed power ⁽¹⁾		290.2	306.8	338.4	357.4	388.7	440.2	479.6	524.9	528.5	553.8
EER ⁽¹⁾		2.92	3.02	2.95	3.00	2.89	2.91	2.92	2.86	3.02	2.98
Comfort Application	Seasonal Energy Efficiency Ratio ⁽²⁾ SEER	4.63	4.64	4.61	4.67	4.63	4.63	4.68	4.63	4.71	4.60
	Seasonal energy efficiency ⁽³⁾ η_{s,c}	%	182	183	181	184	182	182	184	182	185
Acoustic data											
Global sound power level - Standard unit ⁽⁴⁾	dB(A)	93	93	93	93	94	94	95	96	97	97
Electrical data											
Maximum current	A	578.0	631.0	678.0	725.0	765.0	772.0	851.0	927.0	934.0	981.0
Starting current	A	692.0	819.0	846.0	917.0	941.0	948.0	1126.0	1264.0	1122.0	1169.0
Refrigeration circuit											
Number of circuits		2	2	2	2	2	2	2	2	3	3
Number of compressors		2	2	2	2	2	2	2	2	3	3
Total refrigerant load - R513A	kg	104	116	116	133	133	144	197	201	209	215
Evaporator											
Nominal water flow rate ⁽¹⁾	m ³ /h	145.9	159.4	171.8	184.6	193.3	220.5	241.0	258.3	274.7	284.0
Nominal pressure drop ⁽¹⁾	kPa	47	39	43	49	52	65	38	49	57	41
Water connections	DN	200	200	200	200	200	200	200	200	200	200

(1) EUROVENT certified data, in accordance with standard EN 14511.

Cooling mode: Evaporator water temperature = 12/7°C | Outdoor air temperature = 35°C

(2) Seasonal energy efficiency of low-temperature room air heating. In accordance with EU Regulation 2016/2281.

(3) Temperature at which cooling capacity is reached equal to that indicated in point (1).

(4) Sound power: in accordance with ISO 3744 and Eurovent 8/1.

Z_(A) B_(B) C_(C) 1100_(D) D_(E) J_(F) 1_(G) HE_(H)

- (A) Z = eProcess
- (B) A = Air cooled unit - B= Air cooled unit with an inverter compressor - C= Air cooled unit all inverter compressors - W = Water cooled unit - X = Water cooled unit with an inverter compressor
- (C) C = Cooling-only units
- (D) 1100 = Approximate power in kW
- (E) S = Single circuit - D = Double circuit- T = Triple circuit
- (F) A = Refrigerant R134A - J= Refrigerant R513A - X= Refrigerant R1234ze - H = Refrigerant 515B
- (G) 1 = Revision number
- (H) A = Standard version - HE = High-efficiency version- SSL = Super "Low noise" version



Air cooled version

Cooling only units

eProcess Plus - ZBC - HE		0560D	0600D	0670D	0710D	0770D	0860D	0930D	0980D	1080D	1160D	1310D	1500D	1600D	1700T	1840T	
Nominal thermal performances - Cooling mode																	
Cooling capacity ⁽¹⁾		567.4	607.5	677.4	719.4	773.4	869.3	941.3	987.3	1089.2	1173.2	1319.1	1503.1	1591.1	1691.2	1831.1	
Total absorbed power ⁽¹⁾		180.7	191.0	214.4	228.4	241.7	274.2	289.6	306.6	342.5	383.4	417.4	492.8	506.7	535.2	600.4	
EER ⁽¹⁾		3.1	3.2	3.2	3.2	3.2	3.2	3.3	3.2	3.18	3.06	3.16	3.05	3.14	3.16	3.05	
Comfort Application	Seasonal Energy Efficiency Ratio ⁽²⁾ SEER	5.02	4.94	4.96	4.97	4.96	4.98	4.94	4.96	4.97	4.94	4.96	4.96	4.93	5.00	4.96	
	Seasonal energy efficiency ⁽³⁾ η_{s,c}	%	198	195	195	196	195	196	195	195	196	195	195	194	197	195	
Acoustic data																	
Global sound power level - Standard unit ⁽⁴⁾		dB(A)	101.0	102.0	102.0	102.0	103.0	103.0	104.0	104.0	104.0	104.0	105.0	106.0	106.0	106.0	106.0
Electrical data																	
Maximum current		A	407.0	414.0	414.0	438.0	513.0	513.0	544.0	666.0	666.0	814.0	821.0	928.0	975.0	1009.0	1117.0
Starting current		A	440.0	446.0	446.0	473.0	596.0	596.0	632.0	794.0	794.0	912.0	919.0	1112.0	1234.0	1137.0	1191.0
Refrigeration circuit																	
Number of circuits			2	2	2	2	2	2	2	2	2	2	2	2	3	3	
Number of compressors			2	2	2	2	2	2	2	2	2	2	2	2	3	3	
Total refrigerant load - R1234A		kg	74	88	95	95	101	108	121	126	130	133	151	210	203	215	218
Evaporator																	
Nominal water flow rate ⁽¹⁾		m ³ /h	97.7	104.6	116.6	123.8	133.1	149.6	162.0	169.9	187.5	201.9	227.0	258.7	273.8	291.0	315.1
Nominal pressure drop ⁽¹⁾		kPa	61	36	46	50	42	53	42	45	54	59	75	53	59	44	56
Water connections		DN	150	150	150	150	200	200	200	200	200	200	200	200	200	200	200

(1) EUROVENT certified data, in accordance with standard EN 14511.

Cooling mode: Evaporator water temperature = 12/7°C | Outdoor air temperature = 35°C

(2) Seasonal energy efficiency of low-temperature room air heating. In accordance with EU Regulation 2016/2281.

(3) Temperature at which cooling capacity is reached equal to that indicated in point (1).

(4) Sound power: in accordance with ISO 3744 and Eurovent 8/1.

Z^(A) B^(B) C^(C) 1100^(D) D^(E) J^(F) 1^(G) SSL^(H)

- (A) Z = eProcess
- (B) A = Air cooled unit - B= Air cooled unit with an inverter compressor - C= Air cooled unit all inverter compressors - W = Water cooled unit - X = Water cooled unit with an inverter compressor
- (C) C = Cooling-only units
- (D) 1100 = Approximate power in kW
- (E) S = Single circuit - D = Double circuit- T = Triple circuit
- (F) A = Refrigerant R134A - J= Refrigerant R513A - X= Refrigerant R1234ze - H = Refrigerant 515B
- (G) 1 = Revision number
- (H) A = Standard version - HE = High-efficiency version- SSL = Super "Low noise" version



Air cooled version

Cooling only units

eProcess Plus - ZBC - SSL		0560D	0600D	0670D	0710D	0770D	0860D	0930D	0980D	1080D	1160D	1310D	1500D	1600D	1700T	1840T	
Nominal thermal performances - Cooling mode																	
Cooling capacity ⁽¹⁾		548.4	584.5	657.4	694.4	746.0	839.3	908.4	953.3	1051.3	1126.2	1266.1	1452.2	1537.1	1640.2	1772.1	
Total absorbed power ⁽¹⁾		187.2	193.5	225.9	242.8	252.0	292.4	306.9	322.1	362.5	393.8	439.6	502.5	524.6	556.0	624.0	
EER ⁽¹⁾		2.9	3.0	2.9	2.9	3.0	2.9	3.0	3.0	2.90	2.86	2.88	2.89	2.93	2.95	2.84	
Comfort Application	Seasonal Energy Efficiency Ratio ⁽²⁾ SEER	4.92	4.87	4.87	4.86	4.87	4.90	4.86	4.87	4.87	4.85	4.88	4.87	4.82	4.92	4.88	
	Seasonal energy efficiency ⁽³⁾ η_{s,c}	%	194	192	192	191	192	193	191	192	192	191	192	192	190	194	192
Acoustic data																	
Global sound power level - Standard unit ⁽⁴⁾		dB(A)	93.0	93.0	93.0	93.0	94.0	95.0	95.0	95.0	96.0	96.0	97.0	98.0	99.0	99.0	99.0
Electrical data																	
Maximum current		A	407.0	414.0	414.0	438.0	513.0	513.0	544.0	666.0	666.0	814.0	821.0	928.0	975.0	1009.0	1117.0
Starting current		A	440.0	446.0	446.0	473.0	596.0	596.0	632.0	794.0	794.0	912.0	919.0	1112.0	1234.0	1137.0	1191.0
Refrigeration circuit																	
Number of circuits			2	2	2	2	2	2	2	2	2	2	2	2	3	3	
Number of compressors			2	2	2	2	2	2	2	2	2	2	2	2	3	3	
Total refrigerant load - R1234A		kg	74	88	95	95	101	108	121	126	130	133	151	210	203	215	218
Evaporator																	
Nominal water flow rate ⁽¹⁾		m ³ /h	94.4	100.6	113.2	119.5	128.5	144.5	156.0	164.1	180.9	193.8	217.9	249.9	264.5	282.3	305.0
Nominal pressure drop ⁽¹⁾		kPa	57	33	43	47	39	49	39	42	51	55	69	49	55	41	52
Water connections		DN	150	150	150	150	200	200	200	200	200	200	200	200	200	200	200

(1) EUROVENT certified data, in accordance with standard EN 14511.

Cooling mode: Evaporator water temperature = 12/7°C | Outdoor air temperature = 35°C

(2) Seasonal energy efficiency of low-temperature room air heating. In accordance with EU Regulation 2016/2281.

(3) Temperature at which cooling capacity is reached equal to that indicated in point (1).

(4) Sound power: in accordance with ISO 3744 and Eurovent 8/1.

Z_(A) B_(B) C_(C) 1100_(D) D_(E) J_(F) 1_(G) HE_(H)

- (A) **Z** = eProcess
- (B) **A** = Air cooled unit - **B**= Air cooled unit with an inverter compressor - **C**= Air cooled unit all inverter compressors - **W** = Water cooled unit - **X** = Water cooled unit with an inverter compressor
- (C) **C** = Cooling-only units
- (D) **1100** = Approximate power in kW
- (E) **S** = Single circuit - **D** = Double circuit- **T** = Triple circuit
- (F) **A** = Refrigerant R134A - **J**= Refrigerant R513A - **X**= Refrigerant R1234ze - **H** = Refrigerant 515B
- (G) **1** = Revision number
- (H) **A** = Standard version - **HE** = High-efficiency version- **SSL** = Super "Low noise" version



Air cooled version

Cooling only units

eProcess Premiere - ZCC - HE		0565D	0615D	0685D	0775D	0845D	0945D	1005D	1195D	1365D	1495D	1615D	1715T	1865T	
Nominal thermal performances - Cooling mode															
Cooling capacity ⁽¹⁾		568.4	616.5	686.4	779.4	852.3	951.0	1010.3	1190.2	1358.0	1497.1	1609.1	1703.2	1850.1	
Total absorbed power ⁽¹⁾		181.6	197.0	220.7	247.4	273.2	301.9	329.1	392.8	438.1	490.9	532.8	560.3	629.3	
EER ⁽¹⁾		3.1	3.1	3.1	3.2	3.1	3.2	3.1	3.0	3.10	3.05	3.02	3.04	2.94	
Comfort Application	Seasonal Energy Efficiency Ratio ⁽²⁾ SEER	5.30	5.23	5.28	5.27	5.23	5.25	5.28	5.20	5.26	5.19	5.15	5.21	5.13	
	Seasonal energy efficiency ⁽³⁾ η_{s,c}	%	209	206	208	208	206	207	208	205	207	205	203	205	
Acoustic data															
Global sound power level - Standard unit ⁽⁴⁾		dB(A)	102.0	103.0	103.0	104.0	104.0	105.0	105.0	105.0	106.0	106.0	107.0	108.0	108.0
Electrical data															
Maximum current		A	400.0	407.0	407.0	498.0	498.0	647.0	647.0	755.0	870.0	941.0	1014.0	1187.0	1187.0
Starting current		A	309.0	316.0	316.0	385.0	385.0	501.0	501.0	609.0	670.0	740.0	837.0	942.0	1042.0
Refrigeration circuit															
Number of circuits			2	2	2	2	2	2	2	2	2	2	3	3	
Number of compressors			2	2	2	2	2	2	2	2	2	2	3	3	
Total refrigerant load - R1234A		kg	74	88	95	101	108	126	131	170	185	201	203	220	
Evaporator															
Nominal water flow rate ⁽¹⁾		m ³ /h	102.0	103.0	103.0	104.0	104.0	105.0	173.9	204.9	233.8	257.7	276.9	293.1	318.4
Nominal pressure drop ⁽¹⁾		kPa	102	103	103	104	104	105	50	54	39	53	63	44	57
Water connections		DN	150	150	150	200	200	200	200	200	200	200	200	200	200

(1) EUROVENT certified data, in accordance with standard EN 14511.

Cooling mode: Evaporator water temperature = 12/7°C | Outdoor air temperature = 35°C

(2) Seasonal energy efficiency of low-temperature room air heating. In accordance with EU Regulation 2016/2281.

(3) Temperature at which cooling capacity is reached equal to that indicated in point (1).

(4) Sound power: in accordance with ISO 3744 and Eurovent 8/1.

Z^(A) B^(B) C^(C) 1100^(D) D^(E) J^(F) 1^(G) SSL^(H)

- (A) Z = eProcess
- (B) A = Air cooled unit - B= Air cooled unit with an inverter compressor - C= Air cooled unit all inverter compressors - W = Water cooled unit - X = Water cooled unit with an inverter compressor
- (C) C = Cooling-only units
- (D) 1100 = Approximate power in kW
- (E) S = Single circuit - D = Double circuit- T = Triple circuit
- (F) A = Refrigerant R134A - J= Refrigerant R513A - X= Refrigerant R1234ze - H = Refrigerant 515B
- (G) 1 = Revision number
- (H) A = Standard version - HE = High-efficiency version- SSL = Super "Low noise" version



Air cooled version

Cooling only units

eProcess Plus - ZBC - SSL		0565D	0615D	0685D	0775D	0845D	0945D	1005D	1195D	1365D	1495D	1615D	1715T	1865T	
Nominal thermal performances - Cooling mode															
Cooling capacity ⁽¹⁾		550.4	601.5	670.4	756.4	829.3	923.4	985.3	1153.2	1315.3	1451.2	1554.1	1648.2	1782.1	
Total absorbed power ⁽¹⁾		188.5	199.8	231.2	256.4	290.0	314.1	340.9	411.9	456.7	503.9	549.2	580.4	655.2	
EER ⁽¹⁾		2.9	3.0	2.9	3.0	2.9	2.9	2.9	2.8	2.88	2.88	2.83	2.84	2.72	
Comfort Application	Seasonal Energy Efficiency Ratio ⁽²⁾ SEER	5.19	5.12	5.17	5.17	5.13	5.17	5.17	5.10	5.19	5.13	5.06	5.11	5.03	
	Seasonal energy efficiency ⁽³⁾ η_{s,c}	%	205	202	204	204	202	204	204	201	205	202	199	201	198
Acoustic data															
Global sound power level - Standard unit ⁽⁴⁾		dB(A)	94.00	94.00	94.00	95.00	96.00	96.00	97.0	97.0	98.0	98.0	100.0	101.0	101.0
Electrical data															
Maximum current		A	400.0	407.0	407.0	498.0	498.0	647.0	647.0	755.0	870.0	941.0	1014.0	1187.0	1187.0
Starting current		A	309.0	316.0	316.0	385.0	385.0	501.0	501.0	609.0	670.0	740.0	337.0	642.0	642.0
Refrigeration circuit															
Number of circuits			2	2	2	2	2	2	2	2	2	2	3	3	
Number of compressors			2	2	2	2	2	2	2	2	2	2	3	3	
Total refrigerant load - R1234A		kg	74	88	95	101	108	126	131	170	185	201	203	220	
Evaporator															
Nominal water flow rate ⁽¹⁾		m ³ /h	94.8	103.5	115.4	130.2	142.8	158.9	169.6	198.5	226.4	249.7	267.5	283.6	306.7
Nominal pressure drop ⁽¹⁾		kPa	58	36	45	41	48	41	47	51	37	50	59	42	53
Water connections		DN	150	150	150	200	200	200	200	200	200	200	200	200	200

(1) EUROVENT certified data, in accordance with standard EN 14511.

Cooling mode: Evaporator water temperature = 12/7°C | Outdoor air temperature = 35°C

(2) Seasonal energy efficiency of low-temperature room air heating. In accordance with EU Regulation 2016/2281.

(3) Temperature at which cooling capacity is reached equal to that indicated in point (1).

(4) Sound power: in accordance with ISO 3744 and Eurovent 8/1.

Z_(A) W_(B) C_(C) 1100_(D) D_(E) J_(F) 1_(G) A_(H)

- (A) **Z** = eProcess
- (B) **A** = Air cooled unit - **B**= Air cooled unit with an inverter compressor - **C**= Air cooled unit all inverter compressors - **W** = Water cooled unit - **X** = Water cooled unit with an inverter compressor
- (C) **C** = Cooling-only units
- (D) **1100** = Approximate power in kW
- (E) **S** = Single circuit - **D** = Double circuit- **T** = Triple circuit
- (F) **A** = Refrigerant R134A - **J**= Refrigerant R513A - **X**= Refrigerant R1234ze - **H** = Refrigerant 515B
- (G) **1** = Revision number
- (H) **A** = Standard version - **HE** = High-efficiency version- **SSL** = Super "Low noise" version



Water cooled version

Cooling only units

eProcess - ZWC		0200S	0230S	0290S	0320S	0380S	0430D	0490D	0540D	0620D	0690D
Nominal thermal performances - Cooling mode											
Cooling capacity ⁽¹⁾		201.7	229.7	289.7	315.6	374.5	433.6	487.5	543.5	618.4	691.4
Total absorbed power ⁽¹⁾		43.3	49.4	61.2	67.9	79.0	88.5	102.2	113.2	129.6	143.7
EER ⁽¹⁾		4.7	4.7	4.7	4.7	4.7	4.9	4.8	4.8	4.8	4.8
Comfort Application	Seasonal Energy Efficiency Ratio ⁽²⁾ SEER	5.82	5.82	5.62	5.73	5.82	6.58	6.46	6.43	6.39	6.39
	Seasonal energy efficiency ⁽³⁾ η_{s,c} %	230	230	222	226	230	260	255	254	253	253
Acoustic data											
Global sound power level - Standard unit ⁽⁴⁾	dB(A)	94	94	96	96	96	97	97	97	97	97
Electrical data											
Maximum current	A	98	112	133	151	173	196	224	245	284	323
Starting current	A	290	350	439	520	612	357	423	512	601	702
Refrigeration circuit											
Number of circuits		1	1	1	1	1	2	2	2	2	2
Number of compressors		1	1	1	1	1	2	2	2	2	2
Total refrigerant load - R513A		kg	44	45	47	47	43	88	88	86	106
Condensador											
Nominal water flow rate ⁽¹⁾		41.7	47.5	59.8	65.3	77.2	89.0	100.5	111.9	127.4	142.3
Nominal pressure drop ⁽¹⁾		30	31	33	38	37	18	22	23	25	27
Water connections		kg	3"	3"	4"	4"	4"	4"	4"	4"	4"- 5"
Evaporator											
Nominal water flow rate ⁽¹⁾		m ³ /h	34.7	39.6	49.9	54.4	64.5	74.6	83.9	93.6	106.5
Nominal pressure drop ⁽¹⁾		kPa	41	47	35	40	56	36	45	42	54
Water connections		DN	100	100	125	125	125	150	150	150	150

(1) EUROVENT certified data, in accordance with standard EN 14511.

Cooling mode: Evaporator water temperature = 12/7°C | Outdoor air temperature = 35°C

(2) Seasonal energy efficiency of low-temperature room air heating. In accordance with EU Regulation 2016/2281.

(3) Temperature at which cooling capacity is reached equal to that indicated in point (1).

(4) Sound power: in accordance with ISO 3744 and Eurovent 8/1.

Z^(A) W^(B) C^(C) 1100^(D) D^(E) J^(F) 1^(G) A^(H)

- (A) **Z** = eProcess
 (B) **A** = Air cooled unit - **B**= Air cooled unit with an inverter compressor - **C**= Air cooled unit all inverter compressors -
W = Water cooled unit - **X** = Water cooled unit with an inverter compressor
 (C) **C** = Cooling-only units
 (D) **1100** = Approximate power in kW
 (E) **S** = Single circuit - **D** = Double circuit- **T** = Triple circuit
 (F) **A** = Refrigerant R134A - **J**= Refrigerant R513A - **X**= Refrigerant R1234ze - **H** = Refrigerant 515B
 (G) **1** = Revision number
 (H) **A** = Standard version - **HE** = High-efficiency version- **SSL** = Super "Low noise" version



Water cooled version

Cooling only units

eProcess - ZWC		0770D	0860D	0950D	1030D	1100D	1180D	1250D	1310D	1390D	1450D	
Nominal thermal performances - Cooling mode												
Cooling capacity ⁽¹⁾		950.4	1025.4	1098.3	1173.2	1250.2	1310.3	1391.2	1455.2	1391.2	1455.2	
Total absorbed power ⁽¹⁾		193.2	209.3	226.0	241.4	256.7	270.2	286.8	301.3	286.8	301.3	
EER ⁽¹⁾		4.9	4.9	4.9	4.9	4.9	4.9	4.9	4.8	4.9	4.8	
Comfort Application	Seasonal Energy Efficiency Ratio ⁽²⁾ SEER	6.39	6.38	6.38	6.41	6.41	6.43	6.39	6.38	6.39	6.38	
	Seasonal energy efficiency ⁽³⁾ η_{s,c} %	253	252	252	253	253	254	253	252	253	252	
Acoustic data												
Global sound power level - Standard unit ⁽⁴⁾	dB(A)	98	98	99	99	99	99	99	99	100	100	
Electrical data												
Maximum current	A	345	375	431	458	483	508	547	586	618	650	
Starting current	A	716	444	566	583	612	630	751	766	830	867	
Refrigeration circuit												
Number of circuits		2	2	2	2	2	2	2	2	2	2	
Number of compressors		2	2	2	2	2	2	2	2	2	2	
Total refrigerant load - R513A	kg	129	133	135	130	154	158	158	162	196	220	
Condensador												
Nominal water flow rate ⁽¹⁾		159.0	176.4	195.1	210.5	225.5	240.9	256.5	269.3	285.8	299.3	
Nominal pressure drop ⁽¹⁾		18	24	22	21	38	39	39	39	40	30	
Water connections	kg	5"	5"	5"	5"	5"	5"	5"	5"	5"	5"	
Evaporator												
Nominal water flow rate ⁽¹⁾		m ³ /h	133.3	147.9	163.6	176.5	189.0	201.9	215.2	225.5	239.4	250.4
Nominal pressure drop ⁽¹⁾		kPa	48	45	34	38	46	55	59	37	48	51
Water connections		DN	150	150	200	200	200	200	200	200	200	

(1) EUROVENT certified data, in accordance with standard EN 14511.

Cooling mode: Evaporator water temperature = 12/7°C | Outdoor air temperature = 35°C

(2) Seasonal energy efficiency of low-temperature room air heating. In accordance with EU Regulation 2016/2281.

(3) Temperature at which cooling capacity is reached equal to that indicated in point (1).

(4) Sound power: in accordance with ISO 3744 and Eurovent 8/1.

Z_(A) X_(B) C_(C) 1100_(D) D_(E) J_(F) 1_(G) A_(H)

- (A) Z = eProcess
- (B) A = Air cooled unit - B= Air cooled unit with an inverter compressor - C= Air cooled unit all inverter compressors - W = Water cooled unit - X = Water cooled unit with an inverter compressor
- (C) C = Cooling-only units
- (D) 1100 = Approximate power in kW
- (E) S = Single circuit - D = Double circuit- T = Triple circuit
- (F) A = Refrigerant R134A - J= Refrigerant R513A - X= Refrigerant R1234ze - H = Refrigerant 515B
- (G) 1 = Revision number
- (H) A = Standard version - HE = High-efficiency version- SSL = Super "Low noise" version



Water cooled version

Cooling only units

eProcess - ZXC		0390S	0490S	0600S	0720D	0810D	0900D	1000D	1110D	1260D	1360D	1520D	1700D
Nominal thermal performances - Cooling mode													
Cooling capacity ⁽¹⁾		389,5	486,5	610,4	727,4	816,3	920,3	1001,3	1117,2	1260,2	1361,1	1524,2	1701,1
Total absorbed power ⁽¹⁾		75,2	94,3	119,5	132,3	150,9	167,3	183,7	210,0	235,1	252,1	273,6	306,5
EER ⁽¹⁾		5,2	5,2	5,1	5,5	5,4	5,5	5,5	5,3	5,4	5,4	5,6	5,6
Comfort Application	Seasonal Energy Efficiency Ratio ⁽²⁾ SEER	7,75	7,68	7,66	7,57	7,69	7,68	7,48	7,40	7,38	7,35	7,50	7,46
	Seasonal energy efficiency ⁽³⁾ η_{s,c}	%	307	304	303	300	305	304	296	293	292	291	297
Acoustic data													
Global sound power level - Standard unit ⁽⁴⁾	dB(A)	97	99	101	98	98	100	100	102	103	103	102	103
Electrical data													
Maximum current	A	193	222	289	326	365	394	424	491	543	582	667	732
Starting current	A	20	20	20	418	507	536	540	607	754	875	960	1179
Refrigeration circuit													
Number of circuits		1	1	1	2	2	2	2	2	2	2	2	2
Number of compressors		1	1	1	2	2	2	2	2	2	2	2	2
Total refrigerant load - R513A	kg	94	94	103	171	171	171	171	195	233	233	315	315
Condensador													
Nominal water flow rate ⁽¹⁾		67,1	83,8	105,1	125,2	140,5	158,4	172,0	192,3	216,9	234,3	262,3	292,7
Nominal pressure drop ⁽¹⁾		50	50	58	50	50	50	50	60	53	60	50	51
Water connections	kg	125	125	125	150	150	150	150	150	150	150	200	200
Evaporator													
Nominal water flow rate ⁽¹⁾	m ³ /h	79,0	99,0	124,0	146,0	165,0	185,0	202,0	226,0	255,0	275,0	306,0	342,0
Nominal pressure drop ⁽¹⁾	kPa	16	16	21	40	40	40	44	40	42	48	42	50
Water connections	DN	125	125	125	150	150	150	150	150	150	150	200	200

(1) EUROVENT certified data, in accordance with standard EN 14511.

Cooling mode: Evaporator water temperature = 12/7°C | Outdoor air temperature = 35°C

(2) Seasonal energy efficiency of low-temperature room air heating. In accordance with EU Regulation 2016/2281.

(3) Temperature at which cooling capacity is reached equal to that indicated in point (1).

(4) Sound power: in accordance with ISO 3744 and Eurovent 8/1.



Air cooled version

Cooling only units

eProcess - ZAC		0335D	0365D	0405D	0465D	0515D	0565D	0645D	0705D	0755D	0805D	0865D
A	mm	3740	3740	3740	4850	4850	4850	6000	6000	6000	7160	7160
B		2260	2260	2260	2260	2260	2260	2260	2260	2260	2260	2260
C		2480	2480	2480	2480	2480	2480	2480	2480	2480	2480	2480
Weight of standard units												
Transport weight	kg	2659	2669	2692	3095	3670	3814	4162	4197	4227	5211	5631

eProcess - ZAC		0935D	0995D	1075D	1115D	1275D	1405D	1505D	1605T	1705T	1805T	1955T
A	mm	8260	8260	9360	9360	10460	11560	11560	11630	11630	12730	12730
B		2260	2260	2260	2260	2260	2260	2260	2260	2260	2260	2260
C		2480	2480	2480	2480	2480	2480	2480	2480	2480	2480	2480
Weight of standard units												
Transport weight	kg	6021	6081	6516	6536	6916	8247	8588	9813	9910	10345	10622



Air cooled version

Cooling only units

eProcess - ZAC - HE/SSL		0345D	0385D	0425D	0475D	0525D	0585D	0655D	0715D	0765D	0815D	
A	mm	4840	4840	4840	6000	6000	6000	7160	7160	7160	8260	
B		2260	2260	2260	2260	2260	2260	2260	2260	2260	2260	
C		2480	2480	2480	2480	2480	2480	2480	2480	2480	2480	
Weight of standard units												
Transport weight HE version	kg	2991	2996	3030	3395	4094	4124	4647	4684	4704	5516	
Transport weight SSL version	kg	5946	6416	6481	6848	6868	7273	8968	9304	10128	10220	

eProcess - ZAC - HE/SSL		0885D	0955D	1025D	1105D	1175D	1335D	1455D	1565D	1655T	1715T	
A	mm	8260	9360	9360	10460	10460	11560	12730	12730	12730	12730	
B		2260	2260	2260	2260	2260	2260	2260	2260	2260	2260	
C		2480	2480	2480	2480	2480	2480	2480	2480	2480	2480	
Weight of standard units												
Transport weight HE version	kg	5946	6416	6481	6848	6868	7273	8968	9304	10128	10220	
Transport weight SSL version	kg	6346	6816	6881	7248	7268	7673	9388	9724	10668	10760	

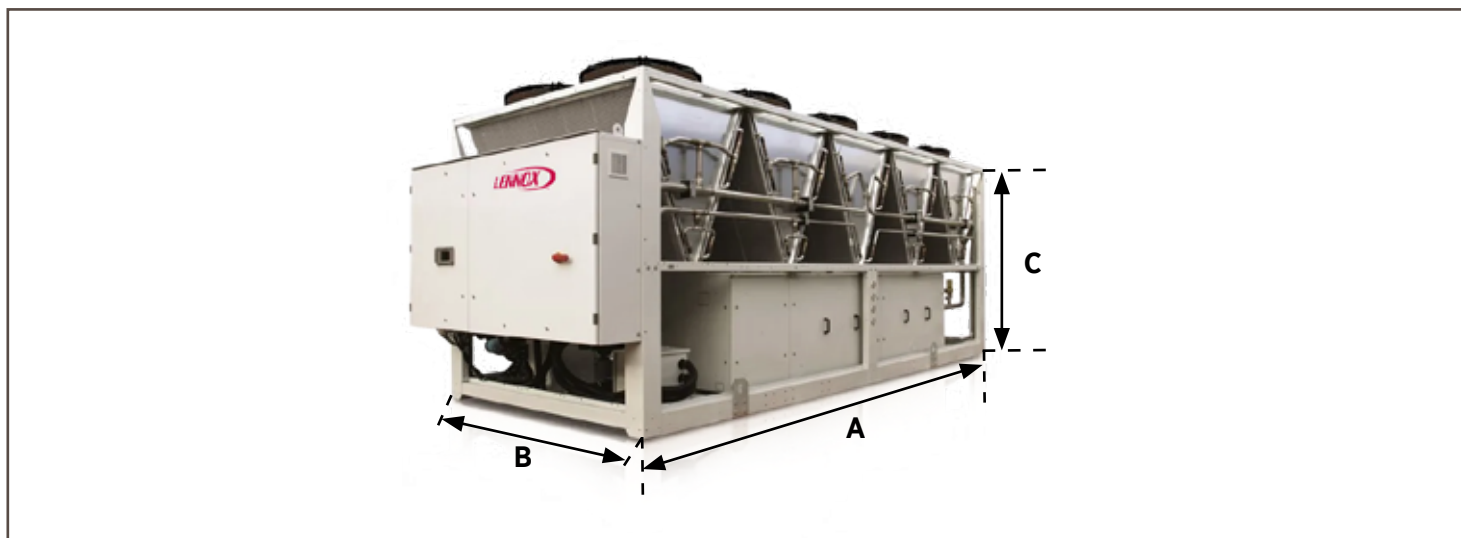



Air cooled version

Cooling only units

eProcess - ZBC - HE/SSL		0560D	0600D	0670D	0710D	0770D	0860D	0930D	0980D	1080D	1160D	1310D	1500D	1600D	1700T	1840T
A		6090	7250	7250	7250	8350	8350	9450	10550	10550	10550	11650	12810	11650	12730	12730
B	mm	2260	2260	2260	2260	2260	2260	2260	2260	2260	2260	2260	2260	2260	2260	2260
C		2480	2480	2480	2480	2480	2480	2480	2480	2480	2480	2480	2480	2480	2480	2480
Weight of standard units																
Transport weight HE version	kg	4314	4727	4797	4807	5641	5741	6146	6416	6526	6868	7248	9134	8386	9840	10277
Transport weight SSL version	kg	4694	5127	5197	5207	6041	6141	6546	6816	6926	7268	7648	9574	8826	10380	10817



Air cooled version

Cooling only units

eProcess - ZCC - HE/SSL		0565D	0615D	0685D	0775D	0845D	0945D	1005D	1195D	1365D	1495D	1615D	1715T	1865T
A		6090	7250	7250	8350	8350	10550	10550	10550	11650	12810	11650	12730	12730
B	mm	2260	2260	2260	2260	2260	2260	2260	2260	2260	2260	2260	2260	2260
C		2480	2480	2480	2480	2480	2480	2480	2480	2480	2480	2480	2480	2480
Weight of standard units														
Transport weight HE version	kg	4144	4607	4707	5021	5141	5766	5876	6977	7763	8734	8036	9640	9687
Transport weight SSL version	kg	4524	5007	5107	5421	5541	6166	10550	7397	8183	9174	8476	10180	10227

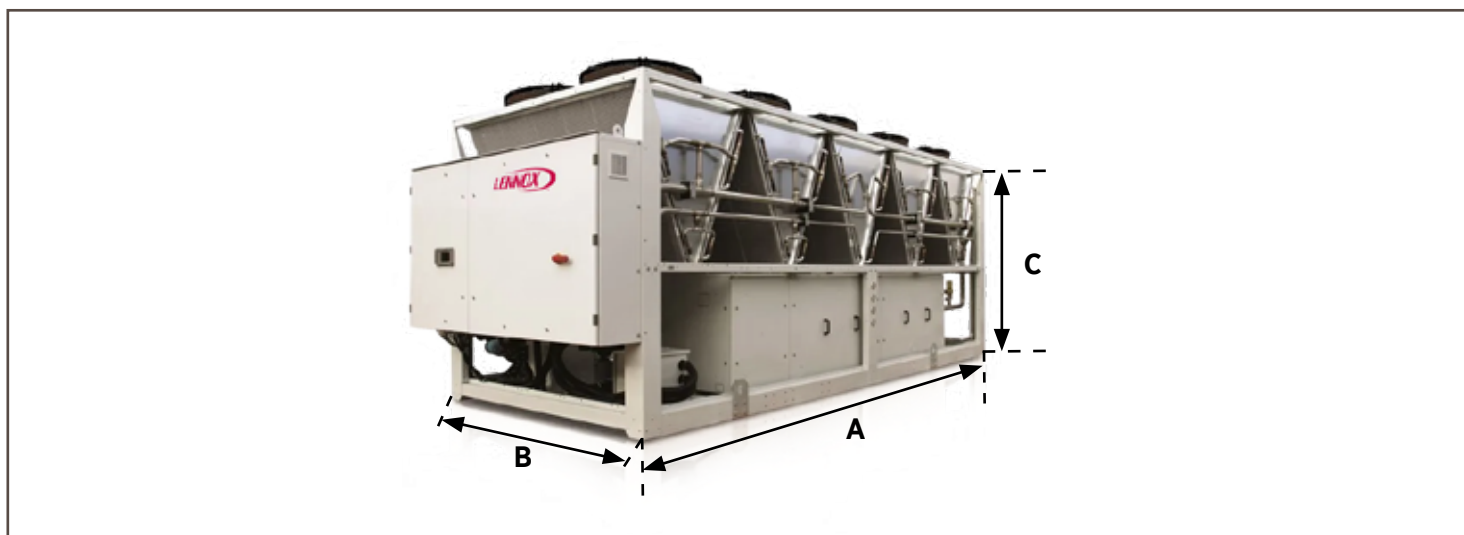



Water cooled version

Cooling only units

eProcess - ZWC		0200S	0230S	0290S	0320S	0380S	0430D	0490D	0540D	0620D	0690D
A	mm	2860	2860	3460	3460	3460	4060	4060	4060	4210	4240
B		1000	1000	1000	1000	1000	1320	1320	1320	1320	1320
C		1670	1670	1670	1670	1670	1850	1850	1850	1900	1900
Weight of standard units											
Transport weight	kg	1300	1320	1720	1730	1740	2400	2400	2750	3140	3260

eProcess - ZWC		0770D	0860D	0950D	1030D	1100D	1180D	1250D	1310D	1390D	1450D
A	mm	4670	4710	4850	4850	4850	4850	5150	5160	5130	5140
B		1320	1320	1320	1320	1320	1320	1320	1320	1320	1320
C		1980	1980	2130	2130	2230	2230	2230	2250	2350	2350
Weight of standard units											
Transport weight	kg	3510	3630	4640	4680	4830	4940	5030	5220	5590	5820



Water cooled version

Cooling only units

eProcess - ZXC		0390S	0490S	0600S	0720D	0810D	0900D	1000D	1110D	1260D	1360D	1520D	1700D
A	mm	3859	3859	3859	3990	3990	3990	4329	4407	4407	4407	4501	4586
B		1531	1531	1591	1676	1676	1676	1676	1814	1844	1844	1979	2024
C		1830	1830	1830	2040	2040	2040	2040	2040	2080	2080	2090	2090
Weight of standard units													
Transport weight	kg	2460	2530	2605	4700	4830	4915	5385	5600	6325	6455	7765	8115

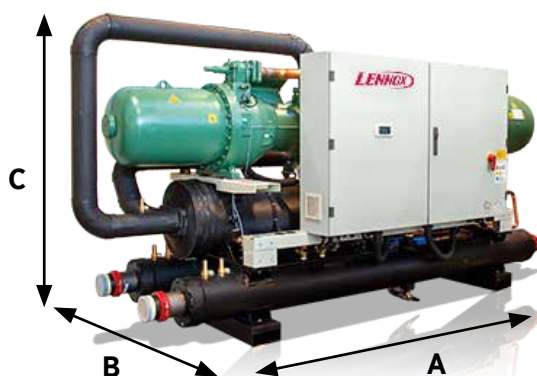

ROOMTOP PACKAGED UNITS



Flatair *Inverter*

125



Flatair Essential

130



Compactair *Inverter*

133



Compactair Essential

141







Aqualean

143



ROOMTOP PACKAGED UNITS

 AIR COOLED

	Flatair Inverter			 22 - 33 kW  20 - 29 kW  3700 - 5600 m ³ /h	 	-
	Flatair Essential			 12 - 27 kW  12,5 - 27,9 kW  2040 - 5060 m ³ /h	 	-
	Compactair Inverter			 22 - 82 kW  20 - 80 kW  5400 - 18700 m ³ /h	 	-
	Compactair Essential			 19 - 97 kW  20 - 105 kW	 	-

ROOMTOP PACKAGED UNITS

 WATER COOLED

	Aqualean			 2,71 - 41 kW  3,37 - 50 kW  670 - 7500 m ³ /h	   	-
---	-----------------	---	---	--	---	---

 Air/Air

 Cooling capacity

 Cafés Restaurants

 Shopping malls

 Heating capacity

 Convenience stores

 Industry

 Water/Air

 Airflow rate

 Non food retail

 Office buildings



ROOMTOP PACKAGED UNITS | Available equipment

■ Standard equipment ● Option

Additional configurations/options are available on request, please contact your sales representative.

		AQUALEAN AWC/AWH	FLATAIR FAH/FASH/FAMH	FLATAIR Essential	COMPACTAIR CAH/CASH/CAMH	COMPACTAIR Essential
AUXILIARY HEATING	1 or 2 steps electric heater	●	●	●	●	●
	Modulating electric heater	-	●	●	●	●
REFRIGERANT	R410A	■	■	■	■	■
	Pressure transducers	-	■	■	■	■
COMPRESSORS	Scroll/MultiScroll	■	■	■	■	■
	Tandem	■	-	-	■	-
	Inverter compressor	-	■	-	■	-
	Compressor noise jacket	●	●	●	●	●
AIR FLOW CONFIGURATION	Horizontal supply	■	■	■	●	■
	Up supply	-	-	-	■	●
	Horizontal return	■	-	-	■	■
SUPPLY FANS	Direct drive fan	■	■	■	■	■
	Variable speed fan	-	■	-	■	●
CONDENSER FANS	Direct drive fan	-	■	-	■	-
	Variable speed fan	-	■	-	■	-
	Variable speed centrifugal fan	■	-	-	-	-
ECONOMISER	Motorised free-cooling/heating	-	●	●	●	●
CASING	Main disconnect switch	●	■	●	■	●
	Pre-coated galvanised steel (White)	-	■	■	■	■
INSULATION	A1 (M0) fire-proof	■	●	-	●	●
AIR FILTER	G2	■	■	■	-	-
	G4	-	-	-	■	■
	M5 + F7	-	●	●	●	●
ANTI-CORROSION PROTECTION	Blue fin coated coil protection for outdoor coil	-	●	-	●	●
	Blue fin coated coil protection for indoor and outdoor coil	-	●	-	●	●
EXHAUST	Exhaust fan	-	-	-	●	●
CONTROL AND COMMUNICATION	Dry & analogic contacts board	●	●	●	●	●
	ModBus RS485 interface	●	●	●	●	●
	BACnet RS485 interface	●	●	●	●	●
	ModBus & BACnet TCP/IP interface	●	●	●	●	●
	Service display	●	●	●	●	●
	Multi-units display	●	●	●	●	●
ADDITIONAL CONTROL AND SAFETY	Smoke detector	-	●	●	●	●
	Remote ambient temperature sensor	-	●	●	●	●
	CO ₂ control	-	●	●	●	●
	Humidity control	-	●	●	●	●
	3 phase detector	●	●	●	●	●
HYDRAULIC OPTIONS	Water filter	●	-	-	-	-
	Flow switches (paddle one or through differential pressure measurement)	●	-	-	-	-
	3-way mixing valve	●	-	-	-	-

FLATAIR

Horizontal packaged air conditioners



R410A



AIR COOLED *Inverter*

❄️ 22 - 33 kW

🔥 20 - 29 kW

🌀 3700 - 5600 m³/h

- # Horizontal design allowing complete indoor installation and **preserving the building's architecture**
- # Packaged and split versions allowing **high adaptability** in any building configuration.
- # **Optimised efficiency** at full and part load operation, thanks to variable speed compressor and EC fans on both sides.
- # Variable speed technology stabilising the air flow and providing accurate supply temperature for **improved indoor air quality**.

THERMODYNAMIC SYSTEM

- # Inverter scroll compressor allowing capacity modulation. 
- # Variable refrigerant control with electronic expansion valve.
- # Variable speed EC axial fans with optimised blade geometry to improve efficiency and reduce noise level.
- # Large surface exchangers for highly efficient heat transfer.
- # Dynamic defrost cycles.

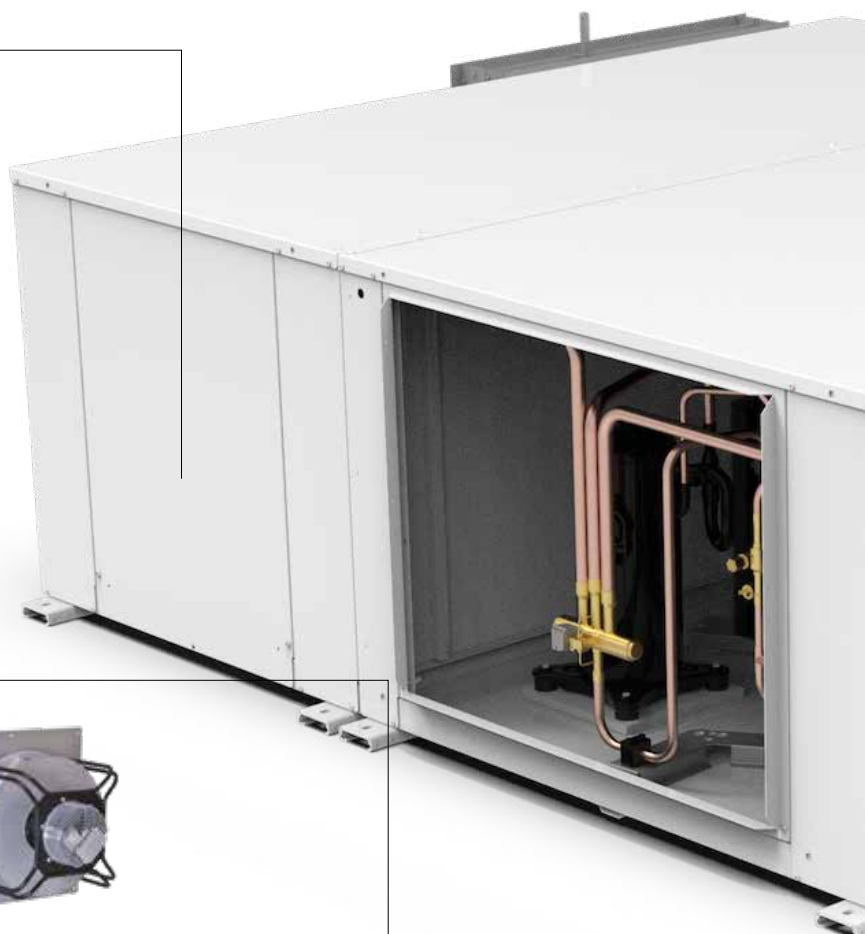

AIR TREATMENT

- # EC motor fans ensuring a precise temperature for better comfort and energy savings.
- # Analogue filter detection to inform when the filters must be changed.
- # IAQ kits for improved indoor air quality inside buildings:
 - G4 (standard)
 - M5 (ePM10) + F7 (ePM1) available as an option.



AUXILIARY HEATING DEVICES

- # Electric heater made of welded blinded elements, with two safety switches to prevent overloading. Available in three different sizes:
 - Standard capacity
 - Medium capacity with one-stage regulation
 - High modulating capacity

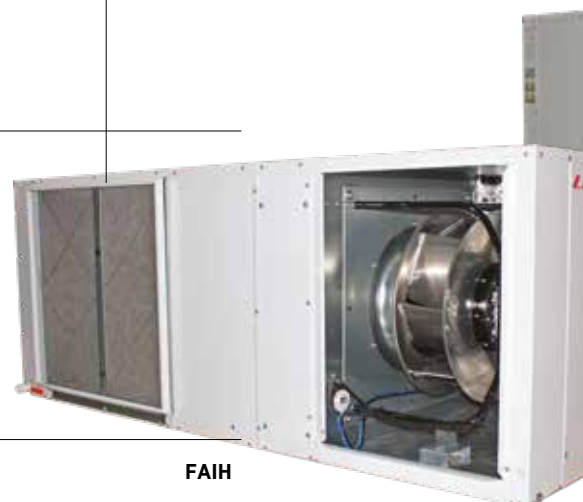

PROTECTION OPTION

- # Outdoor Kit is available as NSR

CONTROL

- # eClimatic electronic controller and intelligent control parameters optimising part-load efficiency.
- # Integrated communication solutions offering flexibility (master/slave, Modbus, BACnet).
- # Several display solutions for different access levels.

eCLIMATIC



DS

Service display



DM

Multi-unit display



DC

Comfort display



CASING & DESIGN

- # Horizontal design for false ceiling installation.
- # Casing built with pre-coated galvanized steel (White).
- # A1 (MO) fire-proof insulation.

ADAPTABILITY

- # Horizontal design to be installed in false ceilings (complete indoor installation).
- # Packaged (FAMH) and split versions (FASH+FAIH), adaptable to any building configuration.
- # Allows connection up to 30m between condensing unit and air treatment unit.
- # Two available configurations:
 - Packaged unit (FAMH);
 - Split version, with outdoor condensing unit (FASH) and indoor air treatment unit (FAIH).

AIRFLOW

- # Several horizontal airflow configurations on both packaged and split versions.
- # Economiser option allows energy savings with free-cooling operation.
- # eDrive: high efficiency ventilation with direct transmission and variable speed drives.
- # Fresh air and free cooling management.

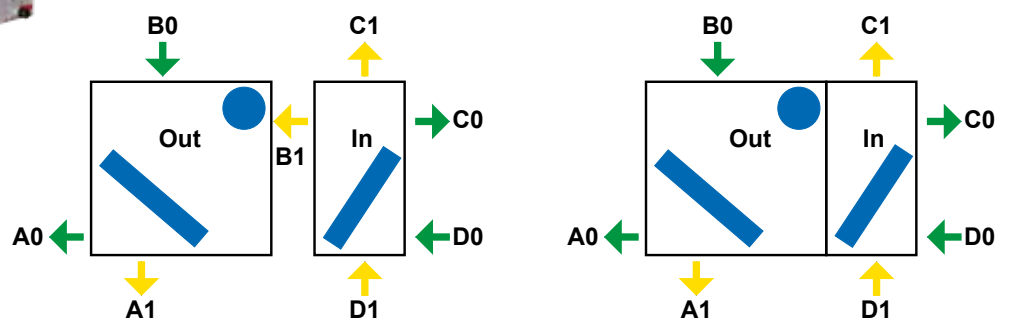

FA^(A) M^(B) H^(C) 020^(D) S^(E) M^(F) 2^(G) M^(H)

- (A) **FA** = FLATAIR
- (B) **M** = Packaged unit - **S** = Condensing unit (Outdoor unit / Split version) - **I** = Air treatment unit (Indoor unit / Split version)
- (C) **H** = Heat pump unit
- (D) Maximum cooling capacity in kW
- (E) **S** = 1 circuit - **D** = 2 circuits
- (F) **M** = R410A
- (G) **2** = Revision number
- (H) **M** = 400V/3/50Hz - **T** = 230V/1/50Hz



Air cooled version

Heat pump units

FLATAIR		FAMH : PACKAGED UNIT		FASH + FAIH : SPLIT VERSION	
		020	035	020	035
Nominal thermal performances - Cooling mode					
Cooling capacity ⁽¹⁾	kW	17,7	27,2	17,7	27,2
Total Power Input	kW	6,3	9,4	6,3	9,4
EER net ⁽¹⁾		2,81	2,91	2,81	2,91
Nominal thermal performances - Heating mode					
Heating capacity ⁽²⁾	kW	16,1	22,6	16,1	22,6
Total Power Input	kW	4,5	7,1	4,5	7,1
COP net ⁽²⁾		3,60	3,2	3,60	3,2
Seasonal efficiencies - Cooling mode					
Seasonal Energy Efficiency Ratio - SEER ⁽³⁾		4,25	4,39	4,25	4,39
Seasonal energy efficiency - η_{s,c} ⁽⁴⁾	%	167,1	172,5	167,1	172,5
Eurovent energy efficiency class - Part load operation		B	B	B	B
Seasonal efficiencies - Heating mode					
Seasonal Coefficient of Performance - SCOP ⁽⁵⁾		3,32	3,32	3,32	3,32
Seasonal energy efficiency - η_{s,h} ⁽⁶⁾	%	129,8	129,7	129,8	129,7
Eurovent energy efficiency class - Part load operation		A	B	A	B
Auxiliary heating					
Gas heating capacity - Standard / High	kW	-	-	-	-
Electric heater capacity - Standard / High		4,5 / 15			
Electric pre-heater capacity - Standard / High		-	-	-	-
Hot water coil capacity Air inlet 20°C/Water		-	-	-	-
Ventilation data					
Minimum airflow rate	m ³ /h	1800	2800	1800	2800
Nominal airflow rate		3700	5600	3700	5600
Maximum airflow rate		4500	6200	4500	6200
Acoustic data - Standard unit					
Outdoor sound power	dB(A)	83	89	83	89
Indoor blower outlet sound power		73	78	73	78
Electrical data					
Maximum power	kW	12,4	19,7	1,4 / 11,1	2,7 / 17
Maximum current	A	23,3	35,0	2,3 / 21,2	4,3 / 30,9
Starting current	A	23,3	35,0	2,3 / 21,2	4,3 / 30,9
Short circuit current	kA	10	10	10	10
Refrigeration circuit					
Number of circuits		1	1	1	1
Number of compressors		1	1	1	1
Refrigerant load	kg	6,6	8	6,6	8

(1) **Cooling mode** : According to EN14511 nominal conditions - Outdoor temperature 35°C DB - Indoor temperature 27°C DB / 19°C WB

(2) **Heating mode** : According to EN14511 nominal conditions - Outdoor temperature 7°C DB / 6°C WB - Indoor temperature 20°C DB

(3) SEER in accordance with standard EN14825.

(4) Space cooling energy efficiency following Ecodesign regulation EU 2016/2281

(5) SCOP in accordance with standard EN 14825 (average climate conditions).

(6) Space heating energy efficiency following Ecodesign regulation EU 2016/2281.



Air cooled version

FLATAIR		FAMH : PACKAGED UNIT		FASH : OUTDOOR UNIT		FAIH : INDOOR UNIT	
		020	035	020	035	020	035
A	mm	1980	2050	1205	1060	775	990
B		1500	1950	1500	1950	1500	1950
C		670	770	670	770	670	770
Weight of standard units							
Basic unit	kg	340	555	220	330	135	225

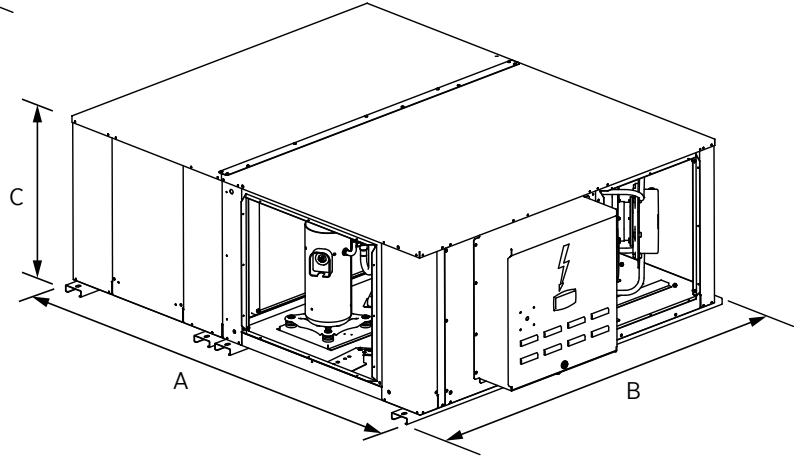
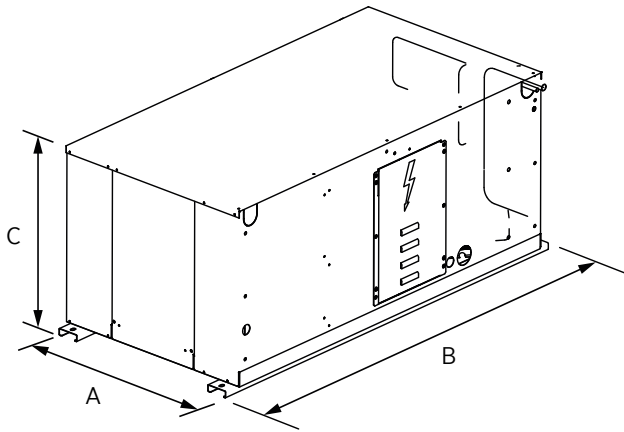
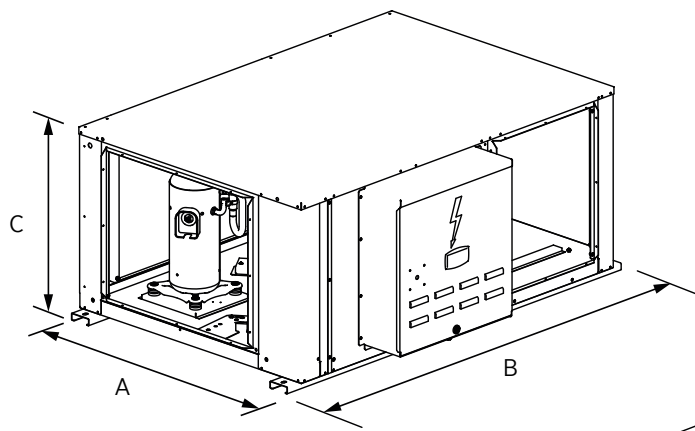

F_(A) **I**_(B) **H**_(C) **015**_(D) **S**_(E) **M**_(F) **3**_(G) **M**_(H)

- (A) **F** = FIH/FIX (ON/OFF Compressors)
- (B) **I** = Packaged unit - **S** = Condensing unit (Outdoor unit / Split version) - **I** = Air treatment unit (Indoor unit / Split version)
- (C) **H** = Heat pump - **X** = Cooling / Heat pump
- (D) Maximum cooling capacity in kW
- (E) **S** = 1 circuit - **D** = 2 circuits
- (F) **M** = R410A
- (G) **2** = Revision number
- (H) **M** = 400V/3/50Hz - **T** = 230V/1/50Hz



Air cooled version

FIX/FIH		12	15	20	25	30
Nominal thermal performances - Cooling mode						
Cooling capacity ⁽¹⁾	kW	12,1	15	19,5	23,5	27
Nominal thermal performances - Heating mode						
Heating capacity ⁽²⁾	kW	12,5	15,5	20,5	25	27,9
Auxiliary heating						
Electric heater capacity - Standard / Average / High	kW	4,5 / 6 / 9			7,5 / 9 / 12	
Ventilation data						
Minimum airflow rate	m ³ /h	1800	2410	3090	3455	3695
Nominal airflow rate		2040	3470	4500	5470	5060
Maximum airflow rate		2300	3575	4850	5750	5500
Acoustic data - Standard unit						
Global sound power level ⁽³⁾	dB(A)	72	76	80	84	83
Electrical data						
Maximum power	kW	0,4	0,8	1	1,3	1,3
Maximum current	A	2,6	2,8	4,3	4,3	4,3
Starting current	A	1,7	1,8	2,8	2,8	2,8
Locked rotor current	A	2,6	2,8	4,3	4,3	4,3

- (1) **Cooling mode** : According to EN14511 nominal conditions - Outdoor temperature 35°C DB - Indoor temperature 27°C DB / 19°C WB
- (2) **Heating mode** : According to EN14511 nominal conditions - Outdoor temperature 7°C DB / 6°C WB - Indoor temperature 20°C DB
- (3) Eurovent Conditions



Air cooled version

FSH		12	15	20	25	30
Nominal thermal performances - Cooling mode						
Cooling capacity ⁽¹⁾	kW	12,1	15	19,5	23,5	27
Absorbed power	kW	5,2	5,9	8	9,6	11,7
Nominal thermal performances - Heating mode						
Heating capacity ⁽²⁾	kW	12,5	15,5	20,5	25	27,9
Absorbed power	kW	4,5	5,4	6,8	8,7	9,9
Auxiliary heating						
Electrical supply	V/Ph/Hz	400V/50+N				
Ventilation data						
Minimum airflow rate	m ³ /h	2400	3740	4095	7460	5000
Nominal airflow rate		2890	4250	5150	5600	5400
Maximum airflow rate		3400	4500	5650	6000	5850
Acoustic data - Standard unit						
Global sound power level ⁽³⁾	dB(A)	77	82	86	81	81
Electrical data						
Maximum power	kW	6,1	7,0	9,4	11,3	13
Maximum current	A	13,4	15,8	19,3	25,7	26,7
Starting current	A	37,1	46,2	71,0	78	82,6
Locked rotor current	A	54,6	68,0	105,3	115,7	122,7

- (1) **Cooling mode** : According to EN14511 nominal conditions - Outdoor temperature 35°C DB - Indoor temperature 27°C DB / 19°C WB
- (2) **Heating mode** : According to EN14511 nominal conditions - Outdoor temperature 7°C DB / 6°C WB - Indoor temperature 20°C DB
- (3) Eurovent Conditions



Air cooled version

FIX/FIH		12	15	20	25	30
A	mm	1980	2050	1205	1060	990
B		1500	1950	1500	1950	1950
C		670	770	670	770	770
Weight of standard units						
Basic unit	kg	340	555	220	330	225

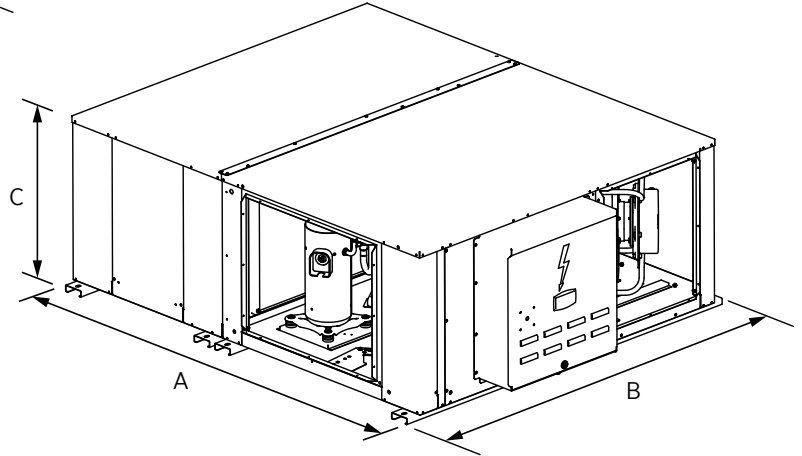
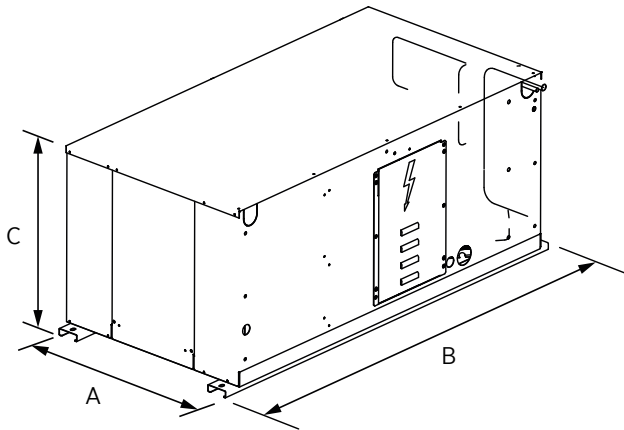
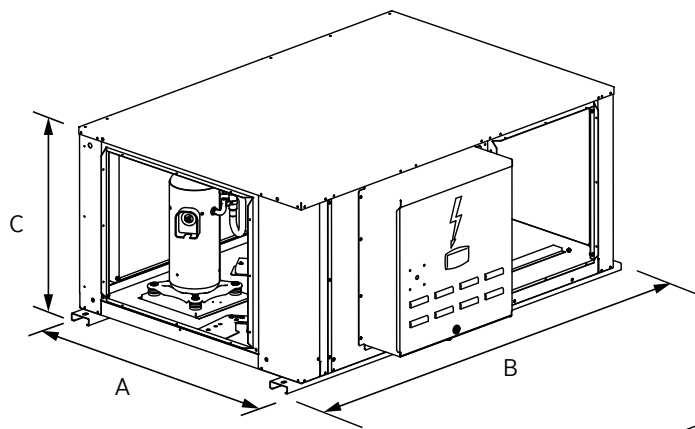

COMPACTAIR

Vertical packaged air conditioners



R410A



AIR COOLED *Inverter*

❄️ 22 - 82 kW

🔥 20 - 80 kW

🌀 5400 - 18700 m³/h

- # Vertical design **offering a reduced footprint.**
- # Indoor unit **preserving the building's architecture.**
- # Packaged and split versions allowing **high adaptability** in any building configuration.
- # **Optimised efficiency** at full and part load operation, thanks to variable speed compressor and EC fans on both sides.
- # Variable speed technology stabilising the air flow and providing accurate supply temperature for **improved indoor air quality.**

AIR TREATMENT

- # EC motor fans ensuring a precise temperature for better comfort and energy savings.
- # Analogue filter detection to inform when the filters must be changed.
- # IAQ kits for improved indoor air quality inside buildings:
 - G4 (standard)
 - M5 (ePM10) + F7 (ePM1) available as an option.



THERMODYNAMIC SYSTEM

- # Inverter scroll compressor allowing capacity modulation. 
- # Variable refrigerant control with electronic expansion valve.
- # Variable speed EC axial fans with optimised blade geometry to improve efficiency and reduce noise level.
- # Large surface exchangers for highly efficient heat transfer.
- # Dynamic defrost cycles.

AUXILIARY HEATING DEVICES

- # Electric heater made of welded blinded elements, with two safety switches to prevent overloading. Available in three different sizes:
 - Standard capacity
 - Medium capacity with a one-stage regulation
 - High modulating capacity



CAIH - INDOOR UNIT



CASING & DESIGN

- # Vertical design for machine room installation.
- # Casing built with pre-coated galvanized steel (White).
- # A1 (M0) fire-proof insulation.
- # Blue fin coated coil protection for outdoor and indoor coil (option)

CAMH - PACKAGED UNIT



ADAPTABILITY

- # Packaged (CAMH) and split versions (CASH+CAIH), adaptable to any building configuration.
- # Allows connection up to 30m between condensing unit and air treatment unit.
- # Two configurations available:
 - Packaged unit (CAMH);
 - Split version, with outdoor condensing unit (CASH) and indoor air treatment unit (CAIH).

CONTROL

- # eCLIMATIC electronic controller and intelligent control parameters optimising part-load efficiency.
- # Integrated communication solutions offering flexibility (master/slave, Modbus, BACnet.)
- # Several display solutions for different access levels.

eCLIMATIC



DS

Service display



DM

Multi-unit display



DC

Comfort display



CASH - OUTDOOR UNIT



AIRFLOW

- # Horizontal or vertical air discharges on both configurations.
- # Economiser option allows energy savings with free-cooling operation.
- # eDrive: high efficiency ventilation with direct transmission and variable speed drives.
- # Fresh air and free cooling management.

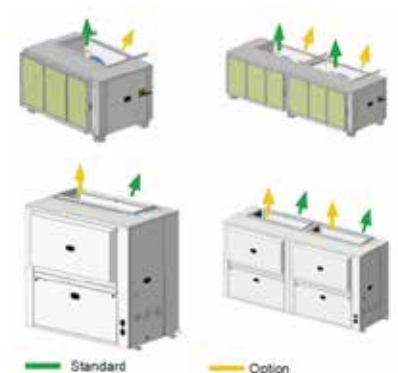

CA_(A) M_(B) H_(C) 020_(D) S_(E) M_(F) 2_(G) M_(H)

(A) CA = COMPACTAIR

(B) M = Packaged unit - S = Condensing unit (Outdoor unit / Split version) - I = Air treatment unit (Indoor unit / Split version)

(C) H = Heat pump unit

(D) Maximum cooling capacity in kW

(E) S = 1 circuit - D = 2 circuits

(F) M = R410A

(G) 2 = Revision number

(H) M = 400V/3/50Hz - T = 230V/1/50Hz



Air cooled version

Heat pump units

COMPACTAIR		CAMH : PACKAGED UNIT					
		020	035	045	060	075	085
Nominal thermal performances - Cooling mode							
Cooling capacity ⁽¹⁾	kW	17,6	26,3	38,3	53,1	64,5	79,6
Total Power Input	kW	5,5	8,7	13,2	18,1	22,7	27,7
EER net ⁽¹⁾		3,19	3,02	2,90	2,92	2,83	2,88
Nominal thermal performances - Heating mode							
Heating capacity ⁽²⁾	kW	15,7	23,7	30,8	46,4	57,0	66,8
Total Power Input	kW	3,8	6,8	9,0	13,7	18,9	21,9
COP net ⁽²⁾		4,09	3,5	3,41	3,39	3,02	3,05
Seasonal efficiencies - Cooling mode							
Seasonal Energy Efficiency Ratio - SEER ⁽³⁾		3,78	4,38	4,59	3,86	3,99	3,98
Seasonal energy efficiency - η _{s,c} ⁽⁴⁾	%	148,1	172,2	180,5	151,2	156,5	156,1
Eurovent energy efficiency class - Part load operation		A	A	B	B	B	B
Seasonal efficiencies - Heating mode							
Seasonal Coefficient of Performance - SCOP ⁽⁵⁾		3,33	3,38	3,30	3,41	3,36	3,35
Seasonal energy efficiency - η _{s,h} ⁽⁶⁾	%	130,3	132,3	128,9	133,3	131,2	131,1
Eurovent energy efficiency class - Part load operation		A	A	A	B	C	C
Auxiliary heating							
Gas heating capacity	kW	-	-	-	-	-	-
Electric heater capacity - Standard / High		10 / 20	10 / 20	10 / 20	15 / 40	15 / 40	15 / 40
Electric pre-heater capacity - Standard / High		-	-	-	-	-	-
Hot water coil capacity Air inlet 20°C/Water		-	-	-	-	-	-
Ventilation data							
Minimum airflow rate	m ³ /h	1800	2800	3700	6200	6700	7500
Nominal airflow rate		3700	5800	7500	12500	13500	15000
Maximum airflow rate		4500	6200	7500	12500	13500	15000
Acoustic data - Standard unit							
Outdoor sound power	dB(A)	84	88	95	90	95	98
Indoor blower outlet sound power		69	78	83	83	85	87
Electrical data							
Maximum power	kW	15,1	20,8	29,0	50,1	57,5	64,5
Maximum current	A	27,3	36,8	50,1	81,7	96,7	108,1
Starting current	A	27,3	36,8	50,1	124,6	183,4	194,8
Short circuit current	kA	10	10	10	10	10	10
Refrigeration circuit							
Number of circuits		1	1	1	2	2	2
Number of compressors		1	1	1	3	3	3
Refrigerant load	kg	6,7	6,7	9	12	14	18

(1) Cooling mode : According to EN14511 nominal conditions - Outdoor temperature 35°C DB - Indoor temperature 27°C DB / 19°C WB

(2) Heating mode : According to EN14511 nominal conditions - Outdoor temperature 7°C DB / 6°C WB - Indoor temperature 20°C DB

(3) SEER in accordance with standard EN14825.

(4) Space cooling energy efficiency following Ecodesign regulation EU 2016/2281

(5) SCOP in accordance with standard EN 14825 (average climate conditions).

(6) Space heating energy efficiency following Ecodesign regulation EU 2016/2281.

CA^(A) M^(B) H^(C) 020^(D) S^(E) M^(F) 2^(G) M^(H)

(A) **CA** = COMPACTAIR

(B) **M** = Packaged unit - **S** = Condensing unit (Outdoor unit / Split version) - **I** = Air treatment unit (Indoor unit / Split version)

(C) **H** = Heat pump unit

(D) Maximum cooling capacity in kW

(E) **S** = 1 circuit - **D** = 2 circuits

(F) **M** = R410A

(G) **2** = Revision number

(H) **M** = 400V/3/50Hz - **T** = 230V/1/50Hz



Air cooled version

Heat pump units

COMPACTAIR		CASH + CAIH : SPLIT VERSION					
		020	035	045	060	075	085
Nominal thermal performances - Cooling mode							
Cooling capacity ⁽¹⁾	kW	17,6	26,3	38,3	53,1	64,5	79,6
Total Power Input	kW	5,5	8,7	13,2	18,1	22,7	27,7
EER net ⁽¹⁾		3,19	3,02	2,90	2,92	2,83	2,88
Nominal thermal performances - Heating mode							
Heating capacity ⁽²⁾	kW	15,7	23,7	30,8	46,4	57,0	66,8
Total Power Input	kW	3,8	6,8	9,0	13,7	18,9	21,9
COP net ⁽²⁾		4,09	3,49	3,41	3,39	3,02	3,0
Seasonal efficiencies - Cooling mode							
Seasonal Energy Efficiency Ratio - SEER ⁽³⁾		3,78	4,38	4,59	3,86	3,99	3,98
Seasonal energy efficiency - η_{s,c} ⁽⁴⁾	%	148,1	172,2	180,5	151,2	156,5	156,1
Eurovent energy efficiency class - Part load operation		A	A	B	B	B	B
Seasonal efficiencies - Heating mode							
Seasonal Coefficient of Performance - SCOP ⁽⁵⁾		3,33	3,38	3,30	3,41	3,36	3,35
Seasonal energy efficiency - η_{s,h} ⁽⁶⁾	%	130,3	132,3	128,9	133,3	131,2	131,1
Eurovent energy efficiency class - Part load operation		A	A	A	B	C	C
Auxiliary heating							
Gas heating capacity		-	-	-	-	-	-
Electric heater capacity - Standard / High	kW	10 / 20	10 / 20	10 / 20	15 / 40	15 / 40	15 / 40
Electric pre-heater capacity - Standard / High		-	-	-	-	-	-
Hot water coil capacity Air inlet 20°C/Water		-	-	-	-	-	-
Ventilation data							
Minimum airflow rate	m ³ /h	1800	2800	3700	6200	6700	7500
Nominal airflow rate		3700	5800	7500	12500	13500	15000
Maximum airflow rate		4500	6200	7500	12500	13500	15000
Acoustic data - Standard unit							
Outdoor sound power	dB(A)	84	88	95	90	95	98
Indoor blower outlet sound power		69	78	83	83	85	87
Electrical data							
Maximum power	kW	2,7 / 12,4	2,7 / 18,2	3,9 / 25,2	5,4 / 44,8	7,7 / 49,9	7,7 / 56,9
Maximum current	A	4,3 / 23,2	4,3 / 32,7	6,1 / 44,2	8,4 / 73,5	12 / 84,9	12 / 96,3
Starting current	A	4,3 / 23,2	4,3 / 32,7	6,1 / 44,2	8,4 / 116,4	12 / 171,6	12 / 183
Short circuit current	kA	10	10	10	10	10	10
Refrigeration circuit							
Number of circuits		1	1	1	2	2	2
Number of compressors		1	1	1	3	3	3
Refrigerant load	kg	6,7	6,7	9	12	14	18

(1) **Cooling mode** : According to EN14511 nominal conditions - Outdoor temperature 35°C DB - Indoor temperature 27°C DB / 19°C WB

(2) **Heating mode** : According to EN14511 nominal conditions - Outdoor temperature 7°C DB / 6°C WB - Indoor temperature 20°C DB

(3) SEER in accordance with standard EN14825.

(4) Space cooling energy efficiency following Ecodesign regulation EU 2016/2281

(5) SCOP in accordance with standard EN 14825 (average climate conditions).

(6) Space heating energy efficiency following Ecodesign regulation EU 2016/2281.

CA_(A) M_(B) H_(C) 020_(D) S_(E) M_(F) 2_(G) M_(H)

(A) CA = COMPACTAIR

(B) M = Packaged unit - S = Condensing unit (Outdoor unit / Split version) - I = Air treatment unit (Indoor unit / Split version)

(C) H = Heat pump unit

(D) Maximum cooling capacity in kW

(E) S = 1 circuit - D = 2 circuits

(F) M = R410A

(G) 2 = Revision number

(H) M = 400V/3/50Hz - T = 230V/1/50Hz



Air cooled version

Heat pump units

COMPACTAIR		CAMH : PACKAGED UNIT					
		020	035	045	060	075	085
Nominal thermal performances - Cooling mode							
Cooling capacity ⁽¹⁾	kW	17,6	26,3	38,3	53,1	64,5	79,6
Total Power Input	kW	5,5	8,7	13,2	18,1	22,7	27,7
EER net ⁽¹⁾		3,19	3,02	2,90	2,92	2,83	2,88
Nominal thermal performances - Heating mode							
Heating capacity ⁽²⁾	kW	15,7	23,7	30,8	46,4	57,0	66,8
Total Power Input	kW	3,8	6,8	9,0	13,7	18,9	21,9
COP net ⁽²⁾		4,09	3,5	3,41	3,39	3,02	3,05
Seasonal efficiencies - Cooling mode							
Seasonal Energy Efficiency Ratio - SEER ⁽³⁾		3,78	4,38	4,59	3,86	3,99	3,98
Seasonal energy efficiency - η_{s,c} ⁽⁴⁾	%	148,1	172,2	180,5	151,2	156,5	156,1
Eurovent energy efficiency class - Part load operation		A	A	B	B	B	B
Seasonal efficiencies - Heating mode							
Seasonal Coefficient of Performance - SCOP ⁽⁵⁾		3,33	3,38	3,30	3,41	3,36	3,35
Seasonal energy efficiency - η_{s,h} ⁽⁶⁾	%	130,3	132,3	128,9	133,3	131,2	131,1
Eurovent energy efficiency class - Part load operation		A	A	A	B	C	C
Auxiliary heating							
Gas heating capacity	kW	-	-	-	-	-	-
Electric heater capacity - Standard / High		10 / 20	10 / 20	10 / 20	15 / 40	15 / 40	15 / 40
Electric pre-heater capacity - Standard / High		-	-	-	-	-	-
Hot water coil capacity Air inlet 20°C/Water		-	-	-	-	-	-
Ventilation data							
Minimum airflow rate	m ³ /h	1800	2800	3700	6200	6700	7500
Nominal airflow rate		3700	5800	7500	12500	13500	15000
Maximum airflow rate		4500	6200	7500	12500	13500	15000
Acoustic data - Standard unit							
Outdoor sound power	dB(A)	84	88	95	90	95	98
Indoor blower outlet sound power		69	78	83	83	85	87
Electrical data							
Maximum power	kW	15,1	20,8	29,0	50,1	57,5	64,5
Maximum current	A	27,3	36,8	50,1	81,7	96,7	108,1
Starting current	A	27,3	36,8	50,1	124,6	183,4	194,8
Short circuit current	kA	10	10	10	10	10	10
Refrigeration circuit							
Number of circuits		1	1	1	2	2	2
Number of compressors		1	1	1	3	3	3
Refrigerant load	kg	6,7	6,7	9	12	14	18

(1) **Cooling mode** : According to EN14511 nominal conditions - Outdoor temperature 35°C DB - Indoor temperature 27°C DB / 19°C WB

(2) **Heating mode** : According to EN14511 nominal conditions - Outdoor temperature 7°C DB / 6°C WB - Indoor temperature 20°C DB

(3) SEER in accordance with standard EN14825.

(4) Space cooling energy efficiency following Ecodesign regulation EU 2016/2281

(5) SCOP in accordance with standard EN 14825 (average climate conditions).

(6) Space heating energy efficiency following Ecodesign regulation EU 2016/2281.

CA^(A) M^(B) H^(C) 020^(D) S^(E) M^(F) 2^(G) M^(H)

(A) **CA** = COMPACTAIR

(B) **M** = Packaged unit - **S** = Condensing unit (Outdoor unit / Split version) - **I** = Air treatment unit (Indoor unit / Split version)

(C) **H** = Heat pump unit

(D) Maximum cooling capacity in kW

(E) **S** = 1 circuit - **D** = 2 circuits

(F) **M** = R410A

(G) **2** = Revision number

(H) **M** = 400V/3/50Hz - **T** = 230V/1/50Hz



Air cooled version

Heat pump units

COMPACTAIR		CASH + CAIH : SPLIT VERSION					
		020	035	045	060	075	085
Nominal thermal performances - Cooling mode							
Cooling capacity ⁽¹⁾	kW	17,6	26,3	38,3	53,1	64,5	79,6
Total Power Input	kW	5,5	8,7	13,2	18,1	22,7	27,7
EER net ⁽¹⁾		3,19	3,02	2,90	2,92	2,83	2,88
Nominal thermal performances - Heating mode							
Heating capacity ⁽²⁾	kW	15,7	23,7	30,8	46,4	57,0	66,8
Total Power Input	kW	3,8	6,8	9,0	13,7	18,9	21,9
COP net ⁽²⁾		4,09	3,49	3,41	3,39	3,02	3,0
Seasonal efficiencies - Cooling mode							
Seasonal Energy Efficiency Ratio - SEER ⁽³⁾		3,78	4,38	4,59	3,86	3,99	3,98
Seasonal energy efficiency - η_{s,c} ⁽⁴⁾	%	148,1	172,2	180,5	151,2	156,5	156,1
Eurovent energy efficiency class - Part load operation		A	A	B	B	B	B
Seasonal efficiencies - Heating mode							
Seasonal Coefficient of Performance - SCOP ⁽⁵⁾		3,33	3,38	3,30	3,41	3,36	3,35
Seasonal energy efficiency - η_{s,h} ⁽⁶⁾	%	130,3	132,3	128,9	133,3	131,2	131,1
Eurovent energy efficiency class - Part load operation		A	A	A	B	C	C
Auxiliary heating							
Gas heating capacity	kW	-	-	-	-	-	-
Electric heater capacity - Standard / High		10 / 20	10 / 20	10 / 20	15 / 40	15 / 40	15 / 40
Electric pre-heater capacity - Standard / High		-	-	-	-	-	-
Hot water coil capacity Air inlet 20°C/Water		-	-	-	-	-	-
Ventilation data							
Minimum airflow rate	m ³ /h	1800	2800	3700	6200	6700	7500
Nominal airflow rate		3700	5800	7500	12500	13500	15000
Maximum airflow rate		4500	6200	7500	12500	13500	15000
Acoustic data - Standard unit							
Outdoor sound power	dB(A)	84	88	95	90	95	98
Indoor blower outlet sound power		69	78	83	83	85	87
Electrical data							
Maximum power	kW	2,7 / 12,4	2,7 / 18,2	3,9 / 25,2	5,4 / 44,8	7,7 / 49,9	7,7 / 56,9
Maximum current	A	4,3 / 23,2	4,3 / 32,7	6,1 / 44,2	8,4 / 73,5	12 / 84,9	12 / 96,3
Starting current	A	4,3 / 23,2	4,3 / 32,7	6,1 / 44,2	8,4 / 116,4	12 / 171,6	12 / 183
Short circuit current	kA	10	10	10	10	10	10
Refrigeration circuit							
Number of circuits		1	1	1	2	2	2
Number of compressors		1	1	1	3	3	3
Refrigerant load	kg	6,7	6,7	9	12	14	18

(1) **Cooling mode** : According to EN14511 nominal conditions - Outdoor temperature 35°C DB - Indoor temperature 27°C DB / 19°C WB

(2) **Heating mode** : According to EN14511 nominal conditions - Outdoor temperature 7°C DB / 6°C WB - Indoor temperature 20°C DB

(3) SEER in accordance with standard EN14825.

(4) Space cooling energy efficiency following Ecodesign regulation EU 2016/2281

(5) SCOP in accordance with standard EN 14825 (average climate conditions).

(6) Space heating energy efficiency following Ecodesign regulation EU 2016/2281.



Air cooled version

Heat pump units

COMPACTAIR		CAMH : PACKAGED UNIT					
		020	035	045	060	075	085
A	mm	1445	1445	1445	2813	2813	2813
B		895	895	895	895	895	895
C		2145	2145	2145	2145	2145	2145
Weight of standard units							
Basic unit	kg	460	485	488	995	1040	1060



Air cooled version

Heat pump units

COMPACTAIR		CASH : OUTDOOR UNIT					
		020	035	045	060	075	085
A	mm	1445	1445	1445	2813	2813	2813
B		895	895	895	895	895	895
C		1410	1410	1410	1410	1410	1410
Weight of standard units							
Basic unit	kg	288	286	306	622	642	662



Air cooled version

Heat pump units

COMPACTAIR		CAIH : INDOOR UNIT					
		020	035	045	060	075	085
A	mm	1445	1445	1445	2813	2813	2813
B		895	895	895	895	895	895
C		836	836	836	836	836	836
Weight of standard units							
Basic unit	kg	172	204	186	378	398	408

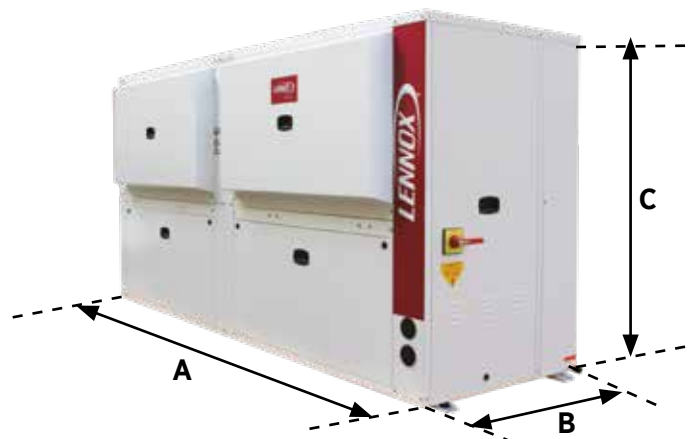
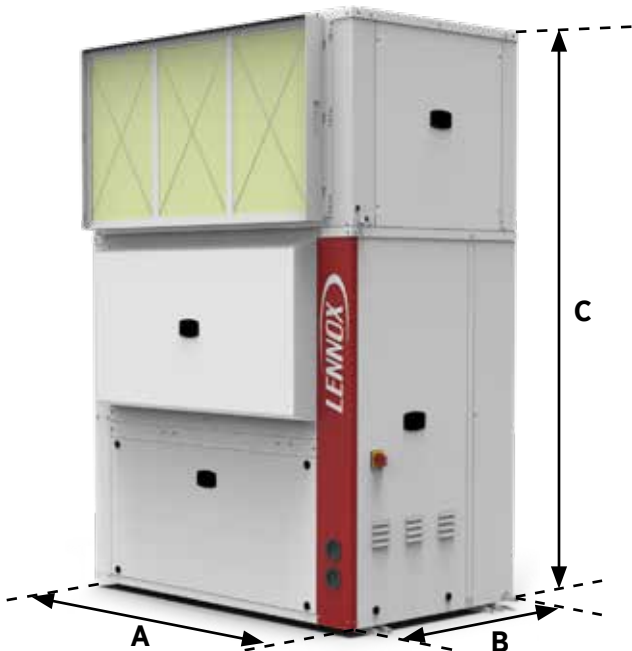

Air treatment unit

CIC/CIH

19→135 kW



CIC/CIH		20S	25S	30S	35S	40S	45D	55D	70D	85D	100D	120D*	140D*
Cooling mode - CIC													
Gross cooling capacity ⁽¹⁾	kW	19,9	24,2	27,9	36,5	41,9	48,7	57,3	72,4	86,0	103,9	116,2	140,6
Net cooling capacity ⁽¹⁾		19,5	23,5	27,0	35,5	40,5	46,5	55,5	69,5	82,0	100,0	111,0	135,0
Heating mode - CIH													
Net heating capacity ⁽²⁾	kW	19,5	25	28,5	36	40	49,5	56,5	72,5	80	108	118	137
Electrical heater capacity (option) Standard/Medium/High		10	10	10	15	15	15	20	20	20	27	27	27
		15	15	15	20	20	20	27	27	27	40	40	40
		20	20	20	27	27	27	40	40	40	50	50	50
Hot water coil capacity ⁽²⁾		31	38	40	56	61	66	91	105	113	171	183	192
Ventilation													
Minimum airflow rate	m ³ /h	3150	4250	4650	6200	6950	7950	9950	12450	14000	17350	19300	21000
Maximum airflow rate		4100	5500	6000	8050	9050	9750	12850	15090	16725	22450	24950	24750
Maximum available static pressure	Pa	685	672	650	729	833	812	747	711	680	812	784	828
Acoustic data ⁽³⁾													
Blower outlet sound power level (Lw)		75	82	82	82	85	86	80	85	87	85	87	89

*The sizes 120D and 140D can be combined only with Condensing Unit ASC/ASH (see page 151)

(1) Evaporating temperature = 7 °C / Ambient air temperature = 35 °C

(2) Condensing temperature = 50 °C / Ambient air temperature = 7 °C BS/6 °C BH

Dimensions

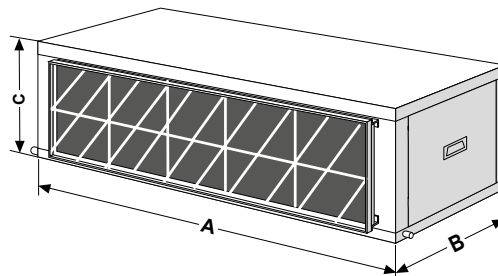

CIC/CIH		20 S	25 S	30 S	35 S	40 S	45 D	55 D	70 D	85 D	100 D	120 D	140 D
A	mm	1195			1445			2250			2900		
B		840			960			960			1140		
C		645			735			735			1140		
Operating weight ⁽¹⁾	kg	108	111	115	150	160	170	242	259	276	470	480	490

(1) Standard unit - Heat pump version

Vertical ductable condensing unit

CSC/CSH
20→100 kW



CSC/CSH		20S	25S	30S	35S	40S	45D	55D	70D	85D	100D
Cooling mode											
Net cooling capacity ⁽¹⁾	kW	18,8	23,1	26,0	33,8	38,8	43,5	54,0	66,2	78,0	96,8
Absorbed power ⁽¹⁾		7,3	9,3	11,0	13,7	15,9	18,9	21,5	27,8	32,6	40,7
Heating mode											
Net heating capacity ⁽¹⁾	kW	19,7	25,9	30,4	37,2	43,7	52,0	61,0	72,8	86,0	105,1
Absorbed power ⁽¹⁾		6,6	8,6	10,7	12,4	14,0	17,4	20,3	24,8	28,5	35,4
Electrical data											
Electrical supply	400V/3Ph/50Hz										
Refrigeration circuit											
Number of compressors / Number of circuits	1/1										
Total refrigerant load	kg	4,3/	5,4/	6,0/	7,8/	9,0/	10,3/	12,5/	15,5/	18,5/	23,0/
Cooling only / Heat pump		4,5	5,5	6,2	8,0	9,3	10,6	12,6	16,0	19,1	25,2
Ventilation data											
Nominal airflow rate	m ³ /h	7600	8500	10000	12000	11700	14000	20000	21000	22000	15500 + 11700
Maximum available static pressure	Pa	178	223	272	209	205	237	299	272	277	239 + 201
Acoustic data											
Blower outlet sound power level (Lw)	dB(A)	82	85	86	85	85	88	87	88	89	92

(1) EUROVENT conditions data

Cooling :

Outdoor temperature = 35°C DB

Entering coil temperature 27°C DB / 19°C WB

Heating :

Outdoor temperature = 7°C DB / 6°C WB

Indoor temperature = 20°C DB

Dimensions

Sizes 20S to 85D

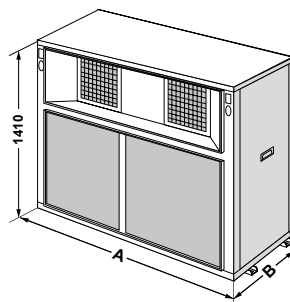

Sizes 100D

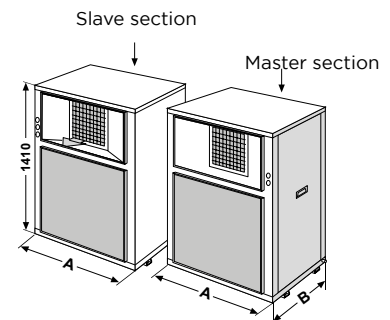

CSC/CSH	20S	25S	30S	35S	40S	45D	55D	70D	85D	100D
A	1194		1445			2251		2 x 1450		
B	745		870			870		870		
Operating weight ⁽¹⁾	262	295	302	357	370	448	529	554	586	2 x 435

(1) Standard unit - Heat pump version

AQUALEAN

Horizontal water-cooled packaged air conditioners



R410A

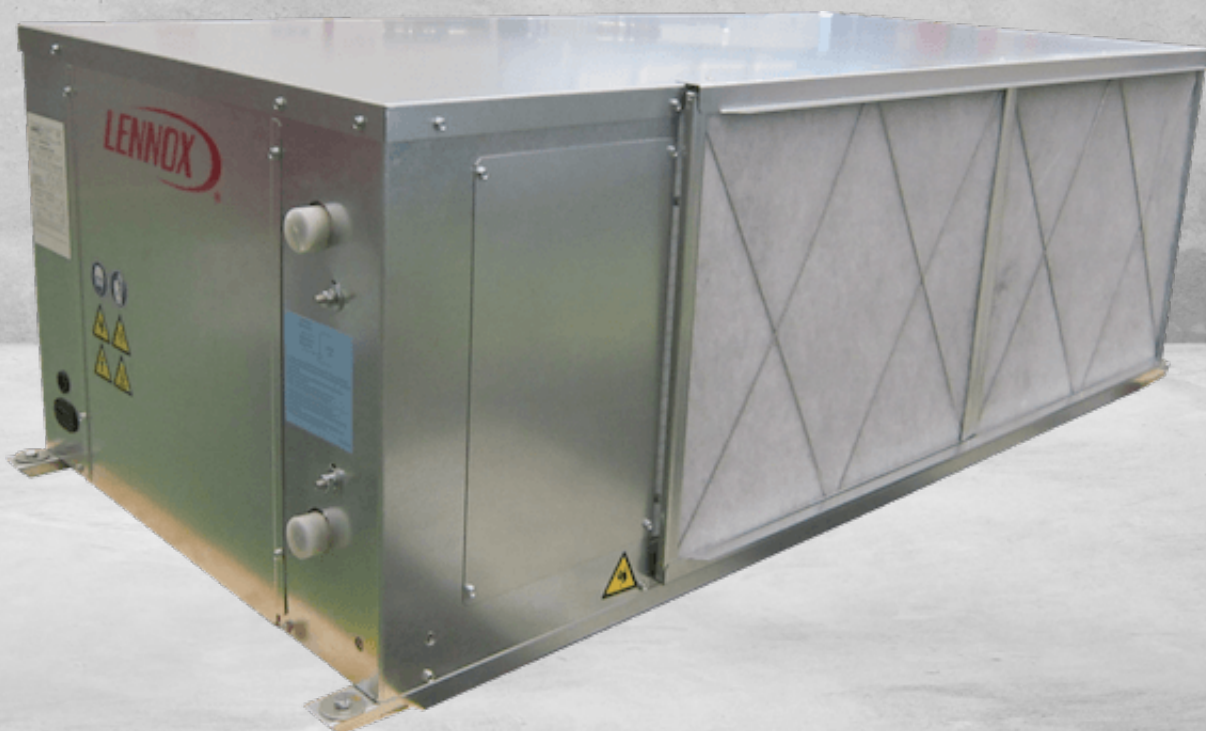

WATER COOLED

 **2.79 - 41 kW**

 **3.37 - 50 kW**

 **670- 7500 m³/h**

- # **Compact solution** with reduced height for ceiling installation.
- # Each unit responds to heating or cooling loads of different individual zones, improving overall **comfort**.
- # Water source heat pump able to reach very **high efficiency** in cooling and heating modes.
- # Variable speed direct transmission ventilation to **save energy** and lower operating costs.

AUXILIARY HEATING DEVICES

- # Electric heater as option on units 007 to 040.
Available in three different sizes:
 - Standard capacity
 - Medium capacity
 - High capacity (only available on models 012 to 040).

AIR TREATMENT

- # EC motor fans ensuring a precise temperature for better comfort and energy savings.
- # Analogue filter detection to inform when the filters must be changed.
- # IAQ kits for improved indoor air quality inside buildings:
 - G2 (standard) for all models
 - M5 (ePM10) + F7 (ePM1) available as an option on models 007 to 040.

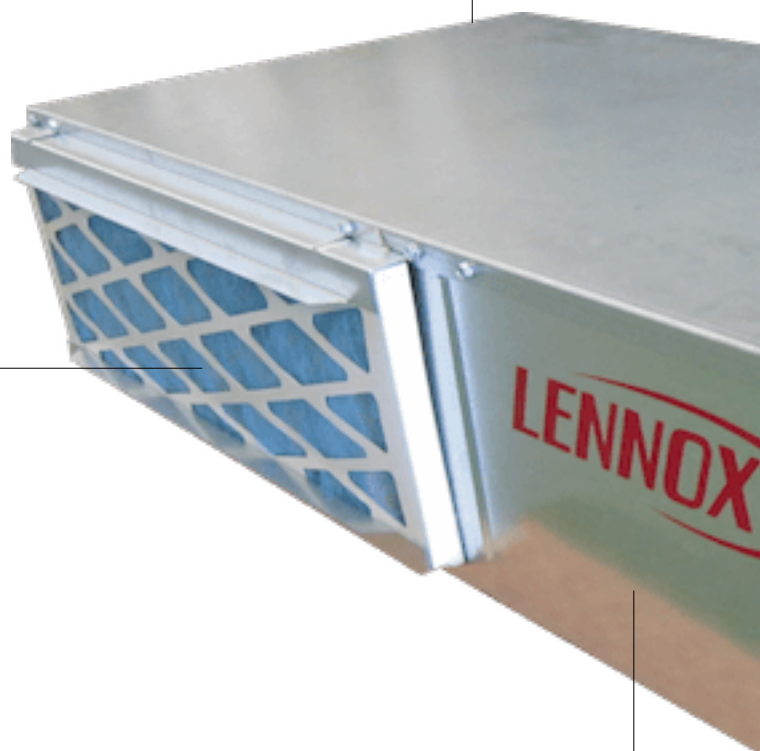

THERMODYNAMIC SYSTEM

- # Rotary compressor on models 003 only.
- # Scroll compressor on models 007 to 020.
- # Tandem scroll compressors on models 007 to 040.
- # Variable refrigerant control with electronic expansion valve.
- # Variable speed fans with optimized blade geometry to improve efficiency and reduce noise level.
- # Large surface exchangers for highly efficient heat transfer.

AIRFLOW

- # Horizontal return air on all models.
- # Models 007 to 020: In-line or perpendicular supply air configuration (both horizontal).
- # Models 025 to 040: horizontal or vertical supply air configuration.

AIRFLOW CONFIGURATION FOR UNIT SIZE 003

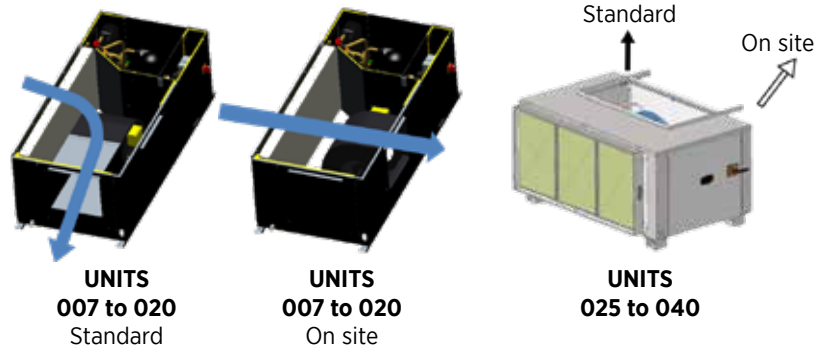
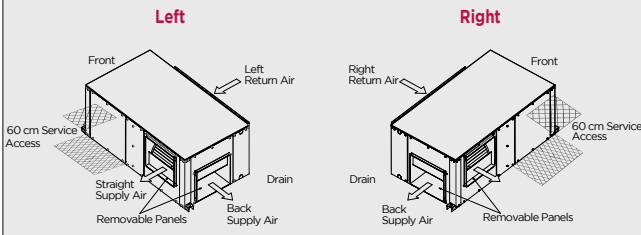

WATER SYSTEM

- # Coaxial heat exchanger on units 003.
- # Brazed plate heat exchanger made of stainless steel on units 007 to 040.
- # Water threaded connections F-G on units 007 to 020.
- # Victaulic connections on units 025 to 040.

CONTROL

- # Climatic60 controller and intelligent control parameters optimising part-load efficiency.
- # Integrated communication solutions offering flexibility (master/slave, Modbus, BACnet).
- # Several display solutions for different access levels.

CLIMATIC60



DS

Service display



DM

Multi-unit display



DC

Comfort display



Comfort display with integrated ambient thermostat
(only for units 003)

- # Cool/Heat/On/Off/Fan & Auto selection
- # Supply / Return air temperature data
- # Condenser Inlet / Outlet Water temperature data
- # Weekly program
- # Monitoring and recording of recent faults

CASING & DESIGN

- # Compact self-supporting casing with very low height to reduce dropped ceilings dimension.
- # Casing built with galvanized steel.
- # Thermal-acoustic insulation is installed in the compressor area to reduce noise level:
 - Units 007 to 020: 25mm A2, s1, d0 (M0) in the air treatment area.
 - Units 007 to 040: 10mm (M1) insulation in air section.

AW^(A) C^(B) 007^(C) S^(D) N^(E) M^(F) 1^(G) M^(H) T^(I)

- (A) **AW** = AQUALEAN
- (B) **C** = Cooling only - **H** = Heat pump
- (C) Approximate cooling capacity in kW
- (D) **S** = 1 circuit
- (E) ---
- (F) **M** = R-410A
- (G) Revision number
- (H) **T** = 230V/1/50Hz - **M** = 400V/1/50Hz
- (I) Water temperature version



Water cooled version

Cooling only units

AQUALEAN - AWC		007	008	010	012	015	018	020
Nominal thermal performances - Cooling mode								
Cooling capacity ⁽¹⁾	kW	6,8	8,0	10,2	11,2	14,5	17,0	19,0
Total Power Input	kW	1,7	2,1	2,6	2,8	3,4	4,2	4,8
EER net ⁽¹⁾		4,00	3,81	3,92	4,00	4,26	4,05	3,96
Nominal thermal performances - Heating mode								
Heating capacity ⁽²⁾	kW	-	-	-	-	-	-	-
Total Power Input	kW	-	-	-	-	-	-	-
COP net ⁽²⁾		-	-	-	-	-	-	-
Seasonal efficiencies - Cooling mode								
Seasonal Energy Efficiency Ratio - SEER ⁽³⁾		-	-	-	-	-	-	-
Seasonal energy efficiency - η_{s,c} ⁽⁴⁾	%	160,50	152,50	150,70	150,40	168,10	159,70	154,30
Eurovent energy efficiency class - Part load operation		-	-	-	-	-	-	-
Seasonal efficiencies - Heating mode								
Seasonal Coefficient of Performance - SCOP ⁽⁵⁾		-	-	-	-	-	-	-
Seasonal energy efficiency - η_{s,h} ⁽⁶⁾	%	-	-	-	-	-	-	-
Eurovent energy efficiency class - Part load operation		-	-	-	-	-	-	-
Auxiliary heating								
Gas heating capacity		-	-	-	-	-	-	-
Electric heater capacity - Standard / High	kW	2 / 5	2 / 5	3 / 9	3 / 9	3 / 9	5 / 12	5 / 12
Electric pre-heater capacity - Standard / High		-	-	-	-	-	-	-
Hot water coil capacity Air inlet 10°C/Water		-	-	-	-	-	-	-
Ventilation data								
Minimum airflow rate	m ³ /h	1010	1250	1550	1620	1850	2060	2450
Nominal airflow rate		1250	1500	1900	2000	2450	2800	3100
Maximum airflow rate		1430	1620	2100	2200	2610	3100	3500
Acoustic data ⁽⁷⁾								
Sound pressure level - Low speed	dB(A)	49	50	48	49	49	46	47
Sound pressure level - High speed		51	52	51	51	53	51	54
Electrical data								
Maximum power	kW	2,7	3,3	4,1	4,9	5,7	6,3	7,6
Maximum current	A	14,4	17,6	24,6	28,6	12,9	14,7	17,9
Starting current	A	61,6	68,6	100,6	130,6	54,1	66,9	77,9
Short circuit current	kA	10	10	10	10	10	10	10
Water cooled condenser								
Nominal water flow rate	l/h	1450	1730	2190	2410	3070	3640	4090
Water pressure drop	kPa	25	30	40	48	40	45	55
Refrigeration circuit								
Number of circuits		1	1	1	1	1	1	1
Number of compressors		1	1	1	1	1	1	1
Refrigerant load	kg	1,3	1,3	1,9	1,9	2,4	2,9	2,9

(1) **Cooling mode** : According to EN14511 nominal conditions - Outdoor temperature 35°C DB - Indoor temperature 27°C DB / 19°C WB

(2) **Heating mode** : According to EN14511 nominal conditions - Outdoor temperature 7°C DB / 6°C WB - Indoor temperature 20°C DB

(3) SEER in accordance with standard EN14825.

(4) Space cooling energy efficiency following Ecodesign regulation EU 2016/2281

(5) SCOP in accordance with standard EN 14825 (average climate conditions).

(6) Space heating energy efficiency following Ecodesign regulation EU 2016/2281.

(7) Sound pressure level has been tested at a distance of 2m from the unit, with duct in aspiration and air discharge, normal absorption in accordance with room size and unit capacity.

AW^(A) C^(B) 007^(C) S^(D) N^(E) M^(F) 1^(G) M^(H) T^(I)

- (A) **AW** = AQUALEAN
 (B) **C** = Cooling only - **H** = Heat pump
 (C) Approximate cooling capacity in kW
 (D) **S** = 1 circuit
 (E) ---
 (F) **M** = R-410A
 (G) Revision number
 (H) **T** = 230V/1/50Hz - **M** = 400V/1/50Hz
 (I) Water temperature version



Water cooled version

Heat pump units

AQUALEAN - AWH		007	008	010	012	015	018	020	025	030	040
Nominal thermal performances - Cooling mode											
Cooling capacity ⁽¹⁾	kW	6,8	8,0	10,2	11,2	14,5	17,0	19,0	24,8	30,8	41,0
Total Power Input	kW	1,7	2,1	2,6	2,8	3,4	4,2	4,8	5,20	6,70	9,50
EER net ⁽¹⁾		4,00	3,81	3,92	4,00	4,26	4,05	3,96	4,77	4,60	4,32
Nominal thermal performances - Heating mode											
Heating capacity ⁽²⁾	kW	8,0	9,5	12,3	13,5	17,0	19,5	22,0	28,3	36,7	49,7
Total Power Input	kW	2,1	2,5	3,2	3,6	4,6	5,1	6,0	6,50	7,80	10,90
COP net ⁽²⁾		3,81	3,80	3,84	3,75	3,70	3,82	3,67	4,35	4,71	4,56
Seasonal efficiencies - Cooling mode											
Seasonal Energy Efficiency Ratio - SEER ⁽³⁾		-	-	-	-	-	-	-	-	-	-
Seasonal energy efficiency - $\eta_{s,c}$ ⁽⁴⁾	%	160,50	152,50	150,70	150,40	168,10	159,70	154,30	259	253	225
Eurovent energy efficiency class - Part load operation		-	-	-	-	-	-	-	-	-	-
Seasonal efficiencies - Heating mode											
Seasonal Coefficient of Performance - SCOP ⁽⁵⁾		-	-	-	-	-	-	-	-	-	-
Seasonal energy efficiency - $\eta_{s,h}$ ⁽⁶⁾	%	103,30	102,50	108,80	105,30	106,30	105,60	99,00	158	166	161
Eurovent energy efficiency class - Part load operation		-	-	-	-	-	-	-	-	-	-
Auxiliary heating											
Gas heating capacity		-	-	-	-	-	-	-	-	-	-
Electric heater capacity - Standard / High	kW	2 / 5	2 / 5	3 / 9	3 / 9	3 / 9	5 / 12	5 / 12	10 / 20	10 / 20	10 / 20
Electric pre-heater capacity - Standard / High		-	-	-	-	-	-	-	-	-	-
Hot water coil capacity Air inlet 10°C/Water		-	-	-	-	-	-	-	-	-	-
Ventilation data											
Minimum airflow rate	m ³ /h	1010	1250	1550	1620	1850	2060	2450	1800	2800	7500
Nominal airflow rate		1250	1500	1900	2000	2450	2800	3100	3700	5800	7500
Maximum airflow rate		1430	1620	2100	2200	2610	3100	3500	4500	6200	3700
Acoustic data ⁽⁷⁾											
Sound pressure level - Low speed	dB(A)	49	50	48	49	49	46	47	50	52	56
Sound pressure level - High speed		51	52	51	51	53	51	54	56	61	63
Electrical data											
Maximum power	kW	2,7	3,3	4,1	4,9	5,7	6,3	7,6	11,5	13,9	17,4
Maximum current	A	14,4	17,6	24,6	28,6	12,9	14,7	17,9	20,2	24,8	34,3
Starting current	A	61,6	68,6	100,6	130,6	54,1	66,9	77,9	55,2	66,0	94,3
Short circuit current	kA	10	10	10	10	10	10	10	10	10	10
Water cooled condenser											
Nominal water flow rate	l/h	1450	1730	2190	2410	3070	3640	4090	4970	6200	8300
Water pressure drop	kPa	25	30	40	48	40	45	55	32	32	39
Refrigeration circuit											
Number of circuits		1	1	1	1	1	1	1	1	1	1
Number of compressors		1	1	1	1	1	1	1	1	1	1
Refrigerant load	kg	1,3	1,3	1,9	1,9	2,4	2,9	2,9	5,2	5,2	9,0

(1) **Cooling mode** : According to EN14511 nominal conditions - Outdoor temperature 35°C DB - Indoor temperature 27°C DB / 19°C WB

(2) **Heating mode** : According to EN14511 nominal conditions - Outdoor temperature 7°C DB / 6°C WB - Indoor temperature 20°C DB

(3) SEER in accordance with standard EN14825.

(4) Space cooling energy efficiency following Ecodesign regulation EU 2016/2281

(5) SCOP in accordance with standard EN 14825 (average climate conditions).

(6) Space heating energy efficiency following Ecodesign regulation EU 2016/2281.

(7) Sound pressure level has been tested at a distance of 2m from the unit, with duct in aspiration and air discharge, normal absorption in accordance with room size and unit capacity.

AWHP (A) 003 (B) M (C) A (D) 1 (E) 0 (F) S (G) L (H) B (I)

- (A) **AW** = AQUALEAN Reversible water source heat pump
- (B) Unit model
- (C) BMS : **M** = Modbus - **B** = Bacnet
- (D) Revision number
- (E) Power supply : **1** = Single-Phase - **3** = Three-Phase
- (F) Electric Heater : **0** = No heater - **1** = Preheater - **2** = Post Heater
- (G) Fan type : **S** = Standard Fan - **C** = Ec fan
- (H) Return air direction : **L** = Left - **R** = Right
- (I) Air discharge direction : **B** = Back - **S** = Straight

Water cooled version Reversible units

AQUALEAN - AWHP		003
Nominal thermal performances - Cooling mode		
Cooling capacity	kW	2,79
Total Power Input	kW	0,86
EER net		3,24
Nominal thermal performances - Heating mode		
Heating capacity	kW	3,37
Total Power Input	kW	0,89
COP net		3,78
Seasonal efficiencies - Cooling mode		
Seasonal Energy Efficiency Ratio - SEER ⁽³⁾		3,07
Seasonal energy efficiency - η_{s,c} ⁽⁴⁾	%	114,89
Seasonal efficiencies - Heating mode		
Seasonal Coefficient of Performance - SCOP ⁽⁵⁾		3,31
Seasonal energy efficiency - η_{s,h} ⁽⁶⁾	%	124,6
Ventilation data		
Nominal airflow rate	m ³ /h	670
External static pressure	Pa	128
Electrical data		
Power Supply Info	V/Ph/ Hz	220 - 240/1/50/ Neutral
Compressor		
Compressor Type		Rotary
Refrigerant		R410A
Total Refrigerant Charge	kg	0,8
Water cooled condenser		
Nominal water flow rate	l/s	0,17
Water side pressure drop	kPa	< 50
Water connection diameter	inch	1/2"
Dimensions and weight		
Length (A)	mm	945
Width (B)	mm	560
Height (C)	mm	377
Weight	kg	61



Entering air conditions of Cooling 27.0°C DB/19°C WB, and Heating 20.0°C DB/15°C WB entering air temperature.

- (3) SEER in accordance with standard EN14825.
- (4) Space cooling energy efficiency following Ecodesign regulation EU 2016/2281
- (5) SCOP in accordance with standard EN 14825 (average climate conditions).
- (6) Space heating energy efficiency following Ecodesign regulation EU 2016/2281.



Water cooled version

Cooling only units

AQUALEAN - AWC		07	08	10	12	15	18	20
A	mm	886	886	1180	1180	1180	1600	1600
B		492	492	623	623	623	703	703
C		441	441	491	491	491	531	531
Weight of standard units								
Basic unit	kg	69	70	109	111	113	148	148



Water cooled version

Heat pump units

AQUALEAN - AWH		07	08	10	12	15	18	20	25	30	40
A	mm	886	886	1180	1180	1180	1600	1600	2049	2049	2049
B		492	492	623	623	623	703	703	895	895	895
C		441	441	491	491	491	531	531	770	770	770
Weight of standard units											
Basic unit	kg	71	72	111	113	116	151	151	370	375	380

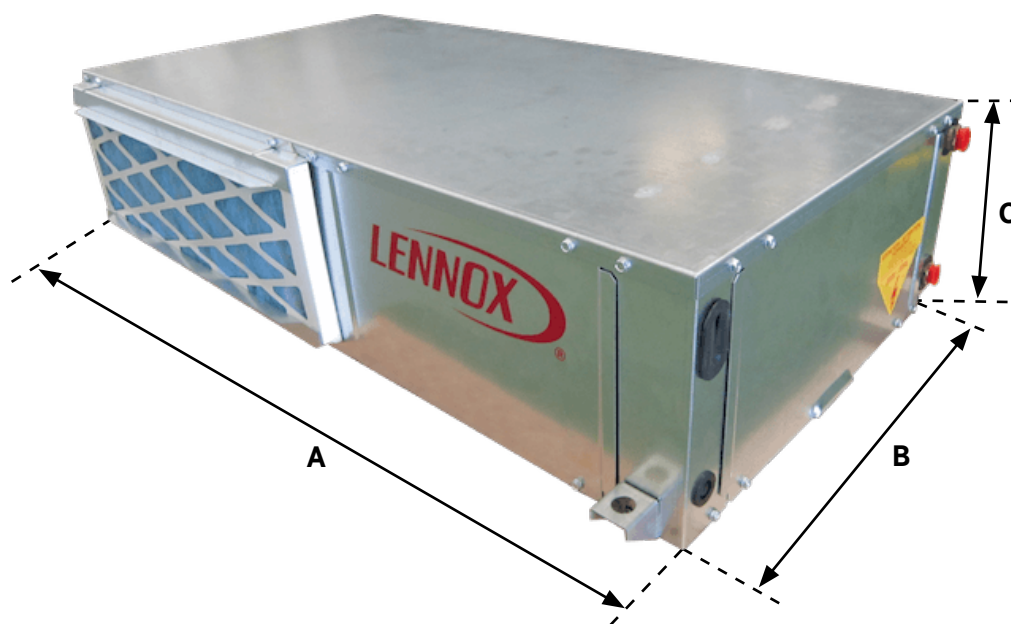

CONDENSING UNITS



ASC / ASH

155



CONDENSING UNITS

 AIR COOLED





ASC / ASH





 **19,7 - 228 kW**

 **19,8 - 218 kW**



-

 Air/Air

 Cooling capacity

 Non food retail

 Hotels

 Water/Air

 Heating capacity

 Shopping malls

 Hospitals

 Office buildings

The condensing units ASC/ASH can be combined with all sizes of indoor unit of Compactair Essential CIC/CIH. (See page 143)

Cooling capacity

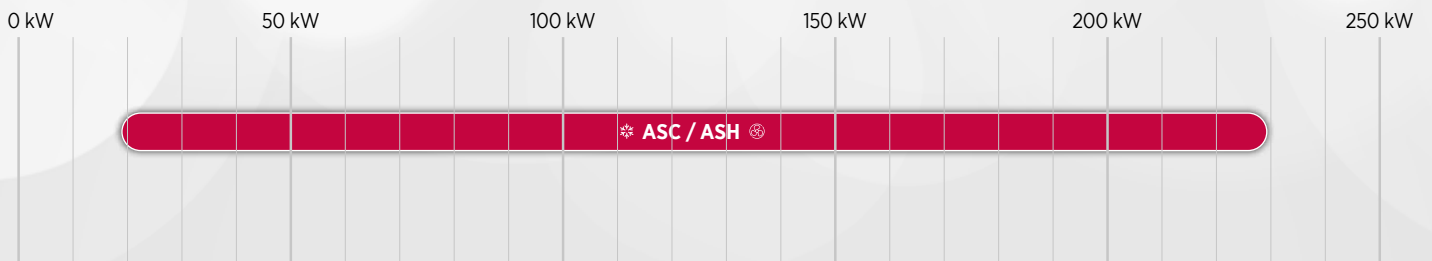

ASC / ASH

Air cooled condensing units



R410A



AIR COOLED

 **19,7 - 228 kW**

 **19,8 - 218 kW**

- # **Highly efficient** design that allows modulation between each circuit.
- # Alternate defrost cycles improve system **reliability** and allows constant heating operation.
- # Morning anticipation can be programmed to **ensure comfort** before the occupation periods.
- # **High adaptability** to any load variation by managing up to four different operating modes and adapting the set point according to outdoor temperature.

CONTROL

- # eClimatic electronic controller and intelligent control parameters optimising part-load efficiency.
- # Integrated communication solutions offering flexibility (master/slave, Modbus, BACnet).
- # Several display solutions for different access levels.

eCLIMATIC



DS

Service display



DM

Multi-Rooftop display



DC

Comfort display



CASING & DESIGN

- # Casing made of galvanized steel sheet metal painted with a white RAL 9002 powdered polyester paint.
- # Rigid, hot dipped galvanized chassis.
- # Unit lifting and handling via the base frame.
- # Side grilles as option to protect the unit during transportation.

EASY MAINTENANCE

- # Refrigerant pressures and superheat on each circuit can be read directly on the service display.
- # Units equipped with high and low-pressure transducers and refrigerant suction temperature sensors.
- # No need to access to refrigerant pressure gauges.



REFRIGERANT CIRCUIT

- # Tandem scroll compressors allowing capacity modulation.
- # High performance fan blades to improve efficiency and reduce noise level.
- # Large surface exchangers for highly efficient heat transfer.
- # Crankcase heater as standard on heat pump and optional with winter operation down to 0°C for cooling only units.
- # Active Acoustic Attenuation System with variable fan speed allows progressive adaptation of the unit to the building load while respecting the noise level constraints and the operating limits (option).



REFRIGERANT CIRCUIT

- # Two circuits allow capacity modulation from units 045D to 230D.
- # On cooling only units, each circuit includes as standard:
 - High pressure switch with automatic reset.
 - Low and high-pressure transducers.
- # On heat pumps units, each circuit includes in addition, as standard:
 - Four-way valve.
 - Liquid receiver.
 - Thermostatic expansion valve.
 - Filter drier.

ENERGY SAVINGS

- # Dynamic and alternate defrost.
- # Morning anticipation and dynamic set point.
- # Scheduling / Time zone Management.



A_(A) S_(B) C_(C) 020_(D) S_(E) N_(F) M_(G) 3_(H) M_(I)

- (A) **A** = ASC/ASH
- (B) **S** = Condensing unit
- (C) **C** = Cooling only - **H** = Heat pump
- (D) Cooling capacity in kW
- (E) **S** = 1 circuit - **D** = 2 circuits
- (F) **N** = Not used
- (G) **M** = R410A
- (H) Revision number
- (I) **M** = 400V/3/50Hz



Air cooled version

ASC / ASH		020S	025S	030S	035S	040S	045D	055D
Nominal thermal performances - Cooling mode (ASC)								
Cooling capacity ⁽¹⁾	kW	19,7	24,7	28,4	36,1	42,0	49,4	56,7
Total Power Input	kW	6,4	8,1	9,6	11,9	14,1	16,2	19,3
EER net ⁽¹⁾		3,06	3,05	2,95	3,03	2,98	3,05	2,94
Nominal thermal performances - Heating mode (ASH)								
Heating capacity ⁽²⁾	kW	19,8	25,0	28,6	36,0	40,2	50,1	57,1
Total Power Input	kW	6,2	7,8	9,2	11,1	13,5	15,6	18,4
COP net ⁽²⁾		3,20	3,2	3,12	3,24	2,98	3,21	3,10
Acoustic data - Standard unit								
Sound power level	dB(A)	76	78	81	80	81	81	84
Electrical data								
Maximum power	kW	8,6	10,8	12,5	16,4	17,7	21,6	25,0
Voltage		400V - 3Ph - 50Hz						
Refrigeration circuit								
Number of circuits		1	1	1	1	1	2	2
Number of compressors		1	1	1	1	1	2	2
Capacity steps		1	1	1	1	1	2	2

- (1) **Cooling mode** : Evaporating temperature = 7°C / Ambient temperature = 35°C
- (2) **Heating mode** : Condensing temperature = 50°C / Ambient temperature = 7°C DB/6°C WB



Air cooled version

ASC / ASH		070D	085D	100D	120D	140D	200D	230D
Nominal thermal performances - Cooling mode (ASC)								
Cooling capacity ⁽¹⁾	kW	72,1	83,9	104,0	115,0	141,0	197,0	228,0
Total Power Input	kW	23,7	28,3	34,3	37,1	46,2	63,3	74,5
EER net ⁽¹⁾		3,04	2,96	3,03	3,10	3,05	3,11	3,06
Nominal thermal performances - Heating mode (ASH)								
Heating capacity ⁽²⁾	kW	71,9	80,3	105,0	114,0	137,0	191,0	218,0
Total Power Input	kW	22,2	25,9	32,4	35,6	43,8	59,9	71,2
COP net ⁽²⁾		3,24	3,10	3,24	3,20	3,13	3,19	3,1
Acoustic data - Standard unit								
Sound power level	dB(A)	83	84	87	87	90	89	82
Electrical data								
Maximum power	kW	32,8	35,5	45,6	48,7	59,9	83,0	96,2
Voltage		400V - 3Ph - 50Hz						
Refrigeration circuit								
Number of circuits		2	2	2	2	2	2	2
Number of compressors		2	2	3	3	3	4	4
Capacity steps		2	2	2	2	2	2	2

- (1) **Cooling mode** : Evaporating temperature = 7°C / Ambient temperature = 35°C
- (2) **Heating mode** : Condensing temperature = 50°C / Ambient temperature = 7°C DB/6°C WB



Air cooled version

ASC / ASH		020S	025S	030S	035S	040S	045D	055D	070D	085D	100D	120D	140D	200D	230D
A	mm	1195		1195			1960				2250			2250	
B		660		980			1195				1420			2300	
C		1375		1635			1635				2155			2250	
Weight of standard units															
Basic unit	kg	168	219	221	239	258	452	463	499	537	748	828	932	1684	1704

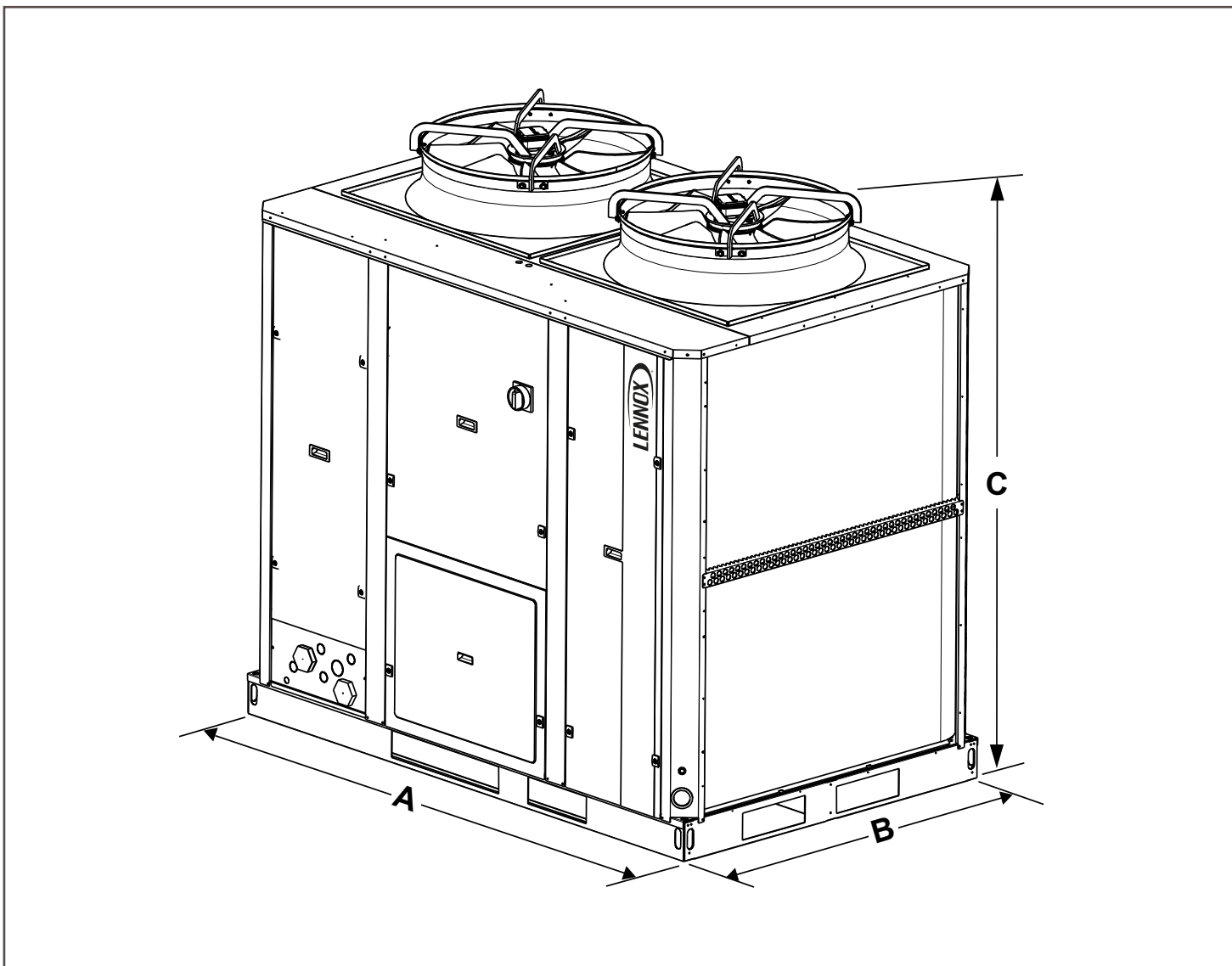

VRF



e-Lite

161



VRF

AIR COOLED / WATER COOLED



e-Lite



8 - 270 kW
3 - 96 HP



- Air/Air
- Water/Air

- Cooling and heating capacity
- Compressor capacity

- Cafés Restaurants
- Convenience stores
- Non food retail
- Food retail

- Cultural and sport centres
- Office buildings
- Hotels
- Storage & Logistics

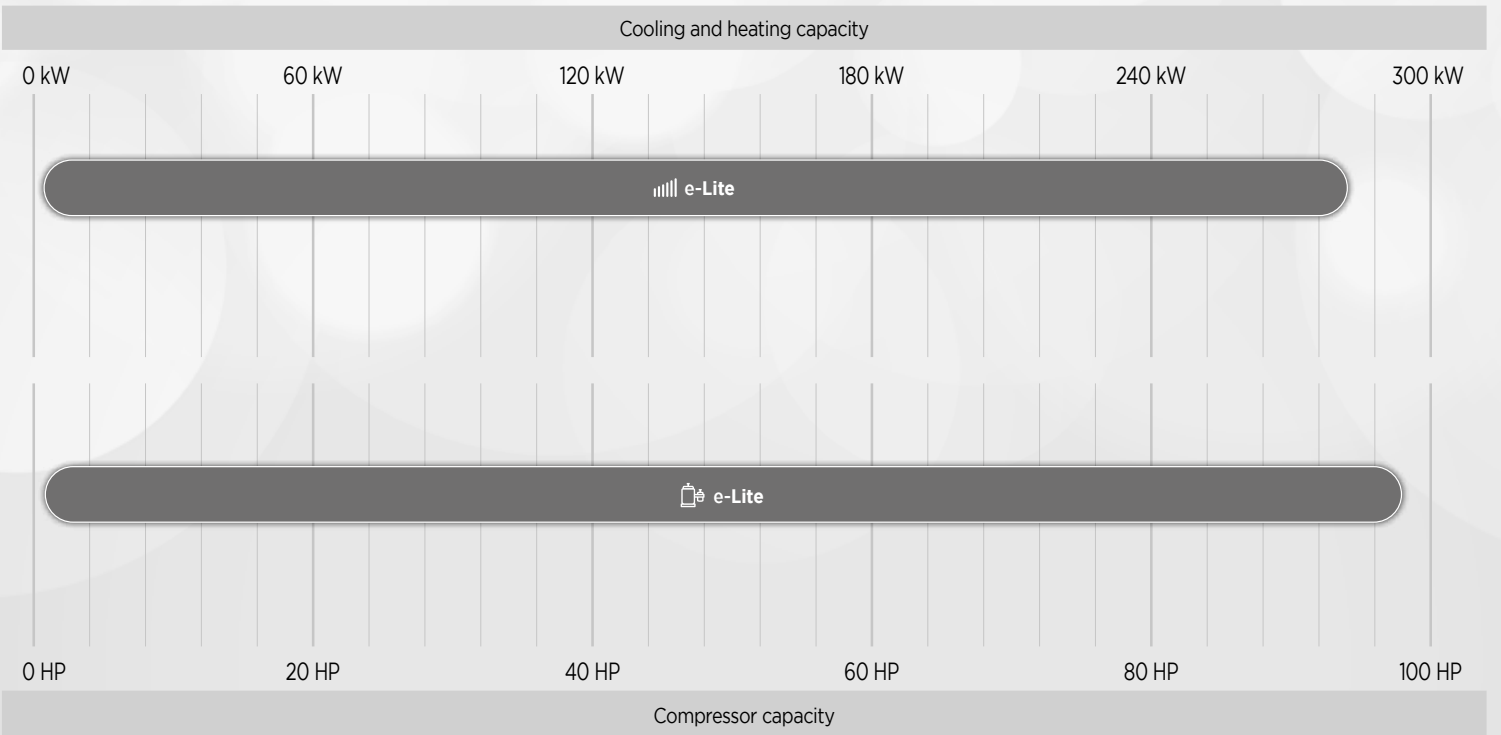

e-Lite

VRF Commercial Air Conditioners



8 - 270 kW
3 - 96 HP



- # The Energy Management System (EMS) allows a perfect adjustment of the evaporating and condensing temperatures for **maximised comfort and energy efficiency**.
- # The integration of cutting-edge technologies guarantees the units' optimal performance even under the harshest climates and environments, thus ensuring the installation's **robustness** in the long run.
- # Available in wall mounted, four-way cassette or floor standing configurations, the e-Lite indoor units **perfectly suit many applications** from office buildings to retail environments of all sizes.
- # Every indoor unit contains smart features to provide **optimal comfort** and increase **efficiency**.

PRECISION COOLING

- # 40% to 100% cooling capacity modulation thanks to inverter compressors.

STEADY PERFORMANCE

- # The automatic refrigerant detection prevents fluctuations and ensures a constant level within the unit.

TOP PROTECTION

- # The innovatively designed auto snow-blowing & dust-clean functions prevent the accumulation of snow and dust on the outdoor unit.

REDUCED ENERGY CONSUMPTION

- # All indoor units feature DC fans for maximum energy efficiency.

PERFECT AIRFLOW

- # Thanks to the 5 swing angles for indoor unit louvres, the air flow direction can be controlled more precisely.

QUIET OPERATION

- # The low sound operation fan motor and optimized fan blades guarantee the air discharges smoothly and provides a quiet living environment.



WIDE OPERATING RANGE

- # The outdoor units operate in a wide ambient temperature range:
From -5°C to 48°C in cooling mode and from -25°C to 24°C in heating mode -> LV-XSO, LV-SO series
From -15°C to 55°C in cooling mode and from -30°C to 30°C in heating mode -> LV-XEO, LV-EO series



INCREASED REFRIGERANT SUBCOOLING

- # +10% energy efficiency thanks to the integration of the Plate Heat Exchanger as a secondary intercooler.

HIGH RELIABILITY

- # The precise oil control technology eliminates any compressor oil shortage problems and thus ensures the system's smooth operation.

EXTENDED LIFESPAN

- # Outdoor units are given as standard an anti-corrosion treatment for non-extreme conditions and can also be customized with heavy anti-corrosion treatment on main components for surface protection against corrosive air, acid rain and saline air (for installations in coastal regions) to extend the overall lifetime .

IDEAL INDOOR TEMPERATURE

- # The DC Inverter fan motor adjusts the airflow based on thermal load instantly providing less temperature fluctuation and an improved living environment.



BENEFITS OF LENNOX VRF

Benefits for End-users	Benefits for Building Owners	Benefits for Consultants	Benefits for Construction Companies
Healthy Operation	Energy Saving Management	Diversified Solutions	Green Solutions
Cost Saving Operation	Reliable Operation	Professional Tool and Support	Space Saving Design
Comfortable Environment	Backup Solution	Design Flexibility	Intelligent Management

APPLICATION SOLUTIONS

High-rise office building	Shopping Malls	Hotels	Villas	Schools
Small and medium-sized office buildings	Retails	Apartments	Hospitals	Airports

	TYPE	PICTURE	CAPACITY RANGE (kW)	KEY TECHNOLOGIES
AIR COOLED- HEAT PUMP	LV-XSO / LV-SO – Top Discharge		LV-XSO 25,2 - 270,0* LV-SO 25,2 - 90	<ul style="list-style-type: none"> # R410A refrigerant # Wide capacity range # Full inverter compressors # Full DC fan motors # Precise oil control # Anti-corrosion protection # Intelligent defrosting technology # Multiple priority modes # Auto addressing
	LV-MSO - Side Discharge		20,0 - 33,5	<ul style="list-style-type: none"> # R410A refrigerant # Wide capacity range # Full DC Inverter Technology # Precise oil control # Advanced Subcooling Technology # Intelligent defrosting technology # 10 priority modes # Auto addressing # Low Standby Power Consumption # 60-step Energy Management # Fan and sensors backup # Advanced Silent Technology # Long Piping Capability # HyperLink: arbitrary Topology Communication # Refrigerant Amount Diagnosis # Enhanced Vapor Injection (EVI) Compressor
	LV-MEO / LV-XMEO - Side Discharge		LV-MEO 25,2 - 61,5 LV-XMEO 25,2 - 200*	<ul style="list-style-type: none"> # R410A refrigerant # Wide capacity range # Full DC Inverter Technology # Precise oil control # Advanced Subcooling Technology # Intelligent defrosting technology # 10 priority modes # Auto addressing # Low Standby Power Consumption # 60-step Energy Management # Fan and sensors backup # Advanced Silent Technology # Long Piping Capability # HyperLink: arbitrary Topology Communication # Refrigerant Amount Diagnosis # Enhanced Vapor Injection (EVI) Compressor
	LV-XEO / LV-EO - Top Discharge		LV-XEO 25,2 - 270,0* LV-EO 25,2 - 90	<ul style="list-style-type: none"> # R410A refrigerant # Wide capacity range # Wide Operation Range # Long Piping Capability # Full DC Inverter Technology # High Efficiency # Anti-corrosion Protection # Refrigerant Cooling PCB # Intelligent Defrosting
	LV-MO2C - MINI VRF		8,0 - 18,0	<ul style="list-style-type: none"> # R410A & R32 refrigerant # Support Any Topology Communication # Super Anti-interference Capability # Virtual Sensor Backup # Full DC Inverter Technology # Advanced Subcooling Technology # 60-step Energy Management # Precise Oil Control # Anti-corrosion Protection # Advanced Silent Technology
	LV-MOEC - MINI VRF		8,0 - 18,0	<ul style="list-style-type: none"> # R410A refrigerant # Wide capacity range # Full inverter compressors # Full DC fan motors # Precise oil control # Anti-corrosion protection # Intelligent defrosting technology # Multiple priority modes # Auto addressing
AIR COOLED- HEAT RECOVERY	LV-RSO – Top Discharge		22,4 - 150,0	<ul style="list-style-type: none"> # R410A refrigerant # Wide capacity range # Full inverter compressors # Full DC fan motors # Precise oil control # Anti-corrosion protection # Intelligent defrosting technology # Multiple priority modes # Auto addressing

* Possibility to combine outdoor units

HYPERLINK

Lennox original communication bus chip greatly simplifies installation and saves installation cost.

HyperLink communication technology supports any wiring pattern rather than just daisy chain connection, reducing the installation cost and the possibility of incorrect connection. It has stronger anti-interference ability, achieving communication distance up to 2000m.

Support Any Topology Communication

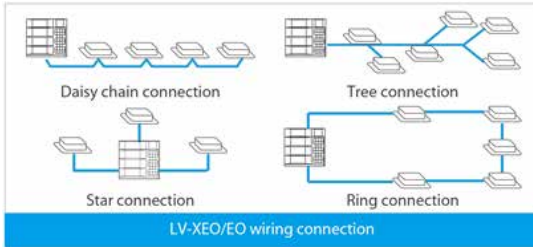

SHIELDBOX

IP55 fully enclosed electric control box provides all-round protection for internal electronic components, greatly improving system RELIABILITY.



SUPERSENSE

Up to 19 sensors are distributed throughout the refrigerant system, and the status of the refrigerant is known anywhere throughout the process, ensuring stable operation. At the same time, combined with the digital twin technology of the refrigerant system, a virtual sensor can be created in the event of a physical sensor failure, so that the system does not shut down in the event of a sensor failure, ensuring comfort.



Failure of a physical sensor

Real-time generation of virtual sensor

Refrigerant Amount Diagnosis

Thanks to the complete sensors, the refrigerant running state is clearly visible, so as to accurately diagnose the amount of refrigerant.

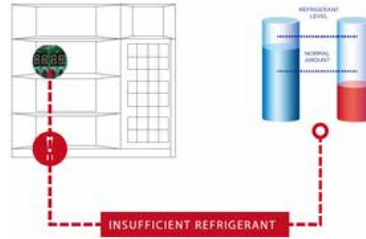

DOCTOR M 2.0

Based on a cloud-based platform of big data and artificial intelligence, the Lennox Series VRF can monitor the operation status of each unit in real time, predict system faults in advance and provide data analysis for system maintenance. Intelligent Bluetooth module and special Bluetooth after-sales kit can further simplify maintenance and improve maintenance efficiency.

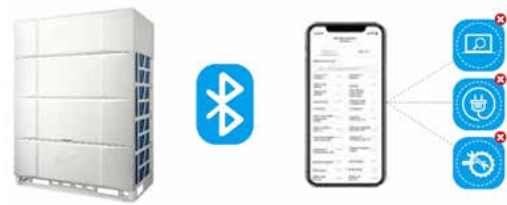

FREE CONTROL



Lennox VRF can provide different control solutions for different application scenarios. From small homes and convenience stores to large shopping malls and complex buildings, Lennox VRF can provide the most appropriate control solutions to achieve centralized and customized management.



3DC Indoor units

One-way Cassette	Two-way Cassette	Compact Four-way Cassette	Four-way Cassette	Arc Duct	Medium Static Pressure Duct
 1.8-7.1kW, 7 models	 2.2-7.1kW, 6 models	 1.5-6.3kW, 7 models	 2.8-16kW, 11 models	 1.5-11.2kW, 10 models	 1.5-16kW, 13 models
High Static Pressure Duct	Wall Mounted	Ceiling & Floor	Floor Standing	Floor Standing	Fresh Air Processing Unit
 7.1-56kW, 12 models	 1.5-9kW, 9 models	 3.6-14kW, 8 models	 2.2-7.1kW, 6 models	 22.4/28kW, 2 models	 11.2-56kW, 8 models

2DC/2AC Indoor Unit

One-way Cassette	Two-way Cassette	Compact Four-way Cassette	Four-way Cassette	Medium Static Pressure Duct
 1.8-7.1kW, 7 models	 2.2-7.1kW, 6 models	 2.2-4.5kW, 5 models (DC) 1.8-4.5kW, 5 models (AC)	 2.8-16kW, 11 models (DC) 2.8-14kW, 10 models (AC)	 2.2-16kW, 11 models (DC) 2.2-14kW, 10 models (AC)
High Static Pressure Duct	Wall Mounted	Ceiling & Floor	Floor Standing	Fresh Air Processing Unit
 7.1-56kW, 12 models	 1.5-9kW, 9 models	 3.6-16kW, 9 models (DC) 3.6-14kW, 8 models (AC)	 2.2-7.1kW, 6 models	 11.2-56kW, 8 models

360° AIRFLOW

New design, round air flow path ensures uniform air flow and temperature distribution.



INDIVIDUAL LOUVER CONTROL

The Individual louver control can control the motors separately, making it possible to control all four louvers independently.



LONG DISTANCE AIR DELIVERY

The Four-way Cassette has an additional 50Pa static pressure for long airflow delivery and is capable of being used in spaces up to 4.5m in floor height.

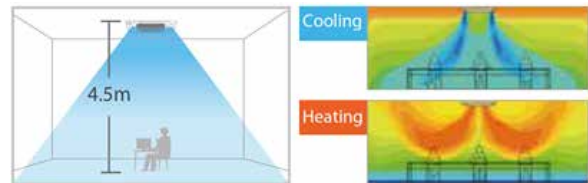

7 FAN SPEEDS

7 indoor fan speed options to meet the needs of different indoor conditions.



SLEEP MODE

The smart sleep mode provides a comfortable sleep period and a refreshing wake up time.



INNOVATIVE PURO-AIR KIT

Protectors of health and safety

OSRAM From Germany - OSRAM quality UV light source

Intertek 1st The world's first air conditioning sterilization product certification

99.9% Effective killing rate of white grape fungus

99.9% Effective killing rate of H1N1

98% Effective killing rate of natural bacteria

CE Ozone-Free
UV leakage-Free

ADDITIONAL ACCESSORIES

The heat recovery ventilator (LV-REC) can greatly reduce energy loss and room temperature fluctuations caused by the ventilation process.

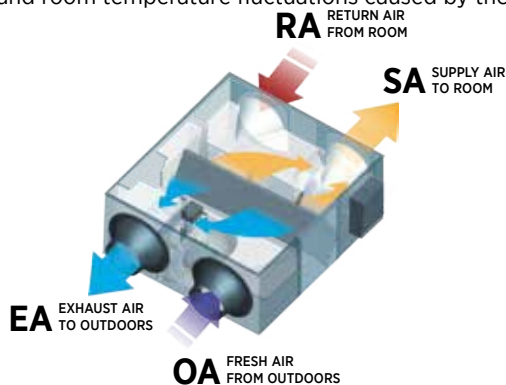

VRF DX AHU CONTROL BOX - AHU

Control Box facilitates raising the EER/COP of the complete AHU system.

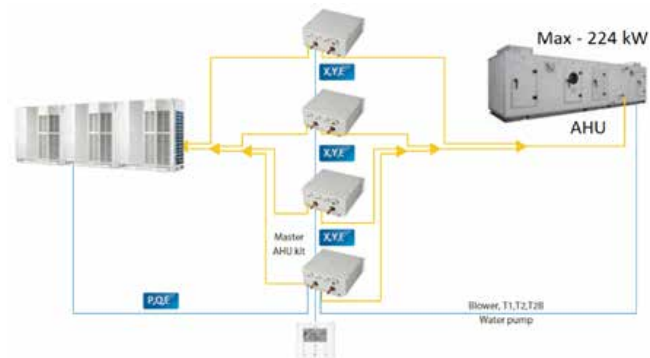

HOT WATER SUPPLY

The LV-RSO system can produce hot water (25°C to 80°C) when providing room air conditioning. The hot water can be used for space heating and domestic hot water, improving room comfort.

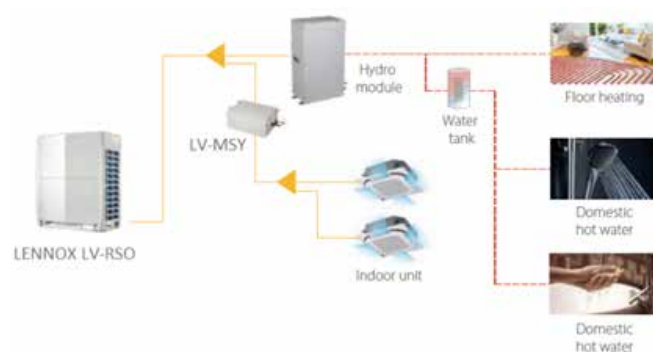

DIAGNOSIS SOFTWARE - LENNOX VRF

Diagnosis Software tool is used to monitor VRF systems and diagnose system errors.

System settings and operating parameters can be accessed easily and data logs can be reviewed for fault prevention purposes.

- # Advance Control
- # Parameter setting and List
- # New Refrigerant System Diagram
- # Device Firmware version query and firmware upgrade
- # Dynamic system diagram only available for specific ODU series
- # Support 12 more languages.



FAN COIL UNITS



ALLEGRA II

174



ARMONIA II

179



COMFAIR II HD

185



INALTO

189



COMFAIR HH/HV

203





FAN COIL UNITS



 AIR COOLED

	 Allegra II	 	 WATER	 0.5 - 8.9 kW  0.7 - 11.6 kW  60 - 1670 m³/h	   	
	 Armonia II	 	 WATER	 1.5 - 10.8 kW  1.9 - 13.5 kW  225 - 1536 m³/h	   	
	 Comfair II HD	 	 WATER	 1.3 - 3.8 kW  1.5 - 4.3 kW  250 - 780 m³/h	   	
	 Inalto	 	 WATER	 3 - 28 kW  3,7 - 37,7 kW  516 - 5668 m³/h	   	
	 Comfair HH/HV	 	 WATER	 2,8 - 50,6 kW  4,9 - 60 kW  840 - 8000 m³/h	   	

*All the range are not Eurovent Certified as they are out of the scope of the certification

 Water/Air

 Cooling capacity
 Heating capacity
 Airflow rate

 Non food retail
 Shopping malls
 Office buildings

 Hotels
 Industry

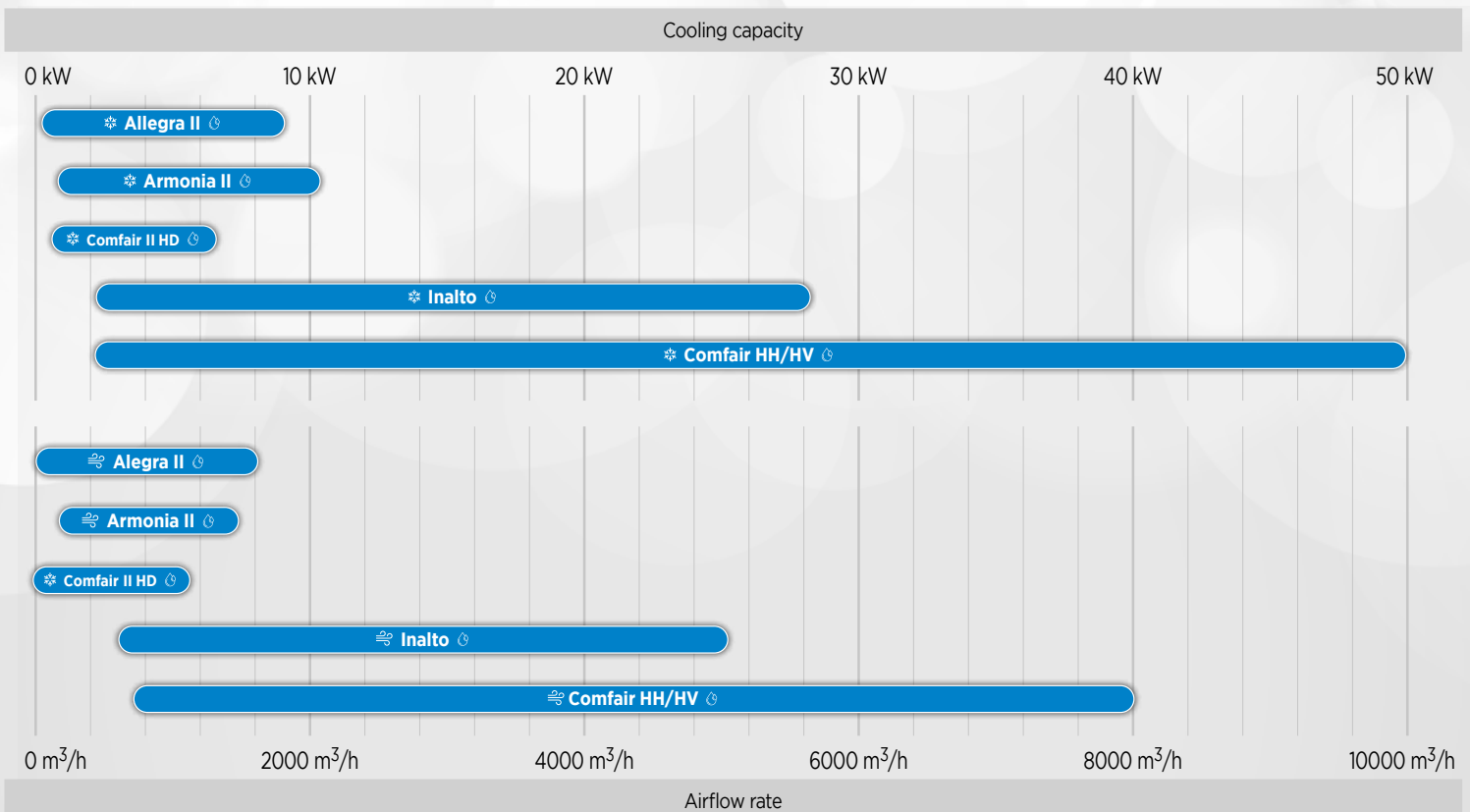

- # Multiple Fan Coil models for **high adaptability** to any building design.
- # **Low environmental impact** on cooling and heating operations by using water as refrigerant.
- # Units available for wall, roof or false ceiling configurations, combining **aesthetics** and **perfect integration** to any space.



Armonia II



Comfair II HD



Allegra II

REDUCED ENERGY CONSUMPTION

- # EC motor fans for maximum energy efficiency and low noise operation.

QUIET OPERATION

- # EC motor fans with optimized fan blades designed to provide smooth and quiet air discharges.



Inalto



Comfair HH/HV

GUARANTEED COMFORT

Low temperature fluctuation and improved living environment on cooling or heating operations.

ADAPTABILITY

Several Fan Coil solutions without casing, for false wall or false ceiling applications, preserving the aesthetics of the room.



ALLEGRA II

Fan coil units



WATER



 **0,5 - 8,9 kW**
 **0,7 - 11,6 kW**
 **60 - 1670 m³/h**

LX^(A) M^(B) 1^(C) L^(D) EC^(E)

- (A) **LX** = Lennox
- (B) **M** = Vertical and horizontal installation with cabinet (bottom air intake) - **MF** = Vertical and horizontal installation with cabinet (frontal air intake)
I = Vertical and horizontal concealed without cabinet (bottom air intake) - **IF** = Vertical concealed without cabinet (frontal air supply)
- (C) **1** = Size (from 1 to 10)
- (D) Hydraulic connections - **R** = Right - **L** = Left
- (E) EC fan motor

2 pipe system (3R coil)

ALLEGRA II			SPEED	1	2	3	4	5	6	7	8	9	10			
Nominal thermal performances - Cooling mode																
* COOLING MODE	Water inlet temperature: 7°C Water outlet temperature: 12°C Air inlet temp: 27°C DB / 19°C WB	Total cooling capacity	W	Max	781	1298	1906	2322	2682	3139	3773	4150	5785	7739		
				Med	694	1142	1691	1930	2231	2620	3168	3379	4957	7159		
				Min	618	967	1455	1615	1710	2089	2527	2744	4255	6413		
		Sensible cooling capacity	W	Max	631	928	1376	1662	2012	2229	2713	3122	4745	6479		
				Med	554	822	1221	1360	1641	1850	2268	2509	4037	5959		
				Min	478	697	1045	1140	1240	1469	1777	2014	3435	5293		
		Water flow rate	l/h	Max	137	227	334	405	469	549	659	729	1014	1361		
				Med	122	200	295	336	390	458	553	595	868	1260		
				Min	108	169	255	282	300	364	441	483	744	1129		
		Water pressure drop	kPa	Max	3,1	8,4	20,2	10,8	17,9	10,8	9	11,5	26,1	28,8		
				Med	2,5	6,7	16,3	7,8	12,7	7,9	6,6	8	20	25		
				Min	2	5	12,5	5,7	7,9	5,3	4,4	5,6	15,6	20,7		
Nominal thermal performances - Heating mode																
HEATING MODE	Air temperature: 20°C Water inlet temp: 45/40°C	Heating Capacity	W	Max	950	1390	2060	2560	2910	3480	4080	4820	6250	8580		
				Med	790	1230	1810	2130	2440	2920	3450	3890	5440	7930		
				Min	620	970	1580	1820	1820	2400	2940	3280	4660	7060		
		Water flow rate	l/h	Max	167	243	359	446	551	607	711	840	1089	1495		
				Med	126	214	315	370	462	508	601	677	948	1382		
				Min	102	170	275	317	348	419	513	571	811	1229		
		Water pressure drop	kPa	Max	3,5	7,8	18,9	10,6	17,7	10,7	8,5	11,4	19,9	22,9		
				Med	2,3	6,3	15	7,6	13	7,8	6,3	7,8	15,6	19,9		
				Min	1,6	4,1	11,8	5,8	7,9	5,6	4,8	5,8	11,8	16,2		
		HEATING MODE	Air temperature: 20°C Water inlet temp: 50°C	Heating Capacity	W	Max	1120	1660	2460	3050	3740	4150	4870	5710	7450	10200
						Med	870	1470	2160	2530	3140	3470	4110	4610	6480	9430
						Min	710	1170	1880	2160	2370	2850	3490	3880	5550	8400
Water flow rate	l/h			Max	137	227	334	405	469	549	659	729	1014	1361		
				Med	122	200	295	336	390	458	553	595	868	1260		
				Min	108	169	255	282	300	364	441	483	744	1129		
Water pressure drop	kPa			Max	2,5	6,9	16,4	8,8	14,6	8,8	7,3	9,3	21,3	23,5		
				Med	1,8	5,5	13,2	6,4	10,4	6,4	5,4	6,5	16,2	20,5		
				Min	1,4	4	10,2	4,7	6,4	4,3	3,6	4,5	12,4	16,9		
Ventilation data																
Air flow rate	m ³ /h			Max	120	211	292	359	398	503	619	728	1002	1511		
				Med	100	184	256	295	336	419	519	586	865	1395		
		Min	78	153	221	249	249	344	421	476	736	1224				
Acoustic data																
Sound power level	dB(A)	Max	38	40	43	40	40	43	46	51	55	62				
		Med	35	36	39	35	36	38	41	45	51	60				
		Min	29	33	36	31	30	33	37	40	47	57				
Sound pressure level	dB(A)	Max	29	31	34	31	31	34	37	42	46	53				
		Med	26	27	30	26	27	29	32	36	42	51				
		Min	20	24	27	22	21	24	28	31	38	48				
Electrical data																
Power input (standard motor)	W	Max	19	22	34	38	48	61	67	98	125	191				
		Med	16	18	29	30	39	50	52	81	103	181				
		Min	12	13	25	25	30	41	43	66	85	167				
Power input (EC motor)	W	Max	-	11	15	13	14	19	22	22	55	131				
		Med	-	10	11	10	10	13	17	24	40	102				
		Min	-	8	10	8	7	10	12	17	29	78				
Absorbed current	A	Max	0,09	0,1	0,15	0,17	0,21	0,28	0,29	0,45	0,55	0,87				
		Med	0,07	0,08	0,13	0,13	0,17	0,22	0,24	0,37	0,45	0,82				
		Min	0,05	0,06	0,11	0,11	0,13	0,18	0,2	0,31	0,37	0,77				

LX^(A) M^(B) 1^(C) L^(D) EC^(E)

(A) LX = Lennox

(B) M = Vertical and horizontal installation with cabinet (bottom air intake) - MF = Vertical and horizontal installation with cabinet (frontal air intake)
 I = Vertical and horizontal concealed without cabinet (bottom air intake) - IF = Vertical concealed without cabinet (frontal air supply)

(C) 1 = Size (from 1 to 10)

(D) Hydraulic connections - R = Right - L = Left

(E) EC fan motor

4 pipe system (3R+1 coil)

ALLEGRA II			SPEED	1	2	3	4	5	6	7	8	9	10
Nominal thermal performances - Cooling mode													
* COOLING MODE Water inlet temperature: 7°C Water outlet temperature: 12°C Air inlet temp.: 27°C DB / 19°C WB	Total cooling capacity	W	Max	830	1158	1876	2272	2687	3079	3223	4072	6395	7709
			Med	734	1012	1651	1890	2226	2570	2708	3349	5490	7169
			Min	658	867	1425	1585	1710	2049	2157	2744	4705	6408
	Sensible cooling capacity	W	Max	621	908	1356	1622	1982	2189	2658	3057	4655	5759
			Med	534	797	1196	1340	1610	1820	2218	2469	3957	5319
			Min	468	687	1030	1115	1220	1439	1747	1969	3365	4698
	Water flow rate	l/h	Max	147	195	327	397	464	539	564	711	1119	1362
			Med	130	174	289	329	401	451	473	606	958	1259
			Min	115	150	249	277	305	359	381	492	823	1130
	Water pressure drop	kPa	Max	1,8	7,6	18,7	10,1	17	10	8,4	11	25	24
			Med	1,5	6	15,1	7,2	11,9	7,3	6,2	7,7	18,9	20
			Min	1,1	4,5	11,6	5,3	7,4	4,9	4,1	5,5	14,4	17
Nominal thermal performances - Heating mode													
HEATING MODE Air temperature: 20°C Water inlet temp.: 65/55°C	Heating Capacity	W	Max	760	1160	1680	1980	2700	2990	3000	3880	5620	6710
			Med	730	1090	1530	1710	2340	2600	2680	3450	5000	6260
			Min	610	940	1380	1520	1870	2270	2390	3050	4420	5750
	Water flow rate	l/h	Max	67	102	147	173	237	262	263	340	493	588
			Med	64	96	134	150	205	228	235	302	439	549
			Min	54	82	121	133	164	199	209	267	388	504
	Water pressure drop	kPa	Max	1	3,2	8,3	10,1	13,8	3,9	12,3	13	14,9	22,3
			Med	0,9	2,8	7,1	7,8	11,3	5	10	9,7	12,1	19,8
			Min	0,7	2,2	5,9	6,3	7,3	3,9	8,2	8,5	9,8	17
HEATING MODE Air temperature: 20°C Water inlet temp.: 70/60°C	Heating Capacity	W	Max	870	1350	1901	2240	3070	3390	3400	4390	6370	7590
			Med	840	1270	1736	1940	2650	2950	3030	3910	5660	7090
			Min	710	1100	1553	1710	2120	2570	2700	3450	5010	6510
	Water flow rate	l/h	Max	77	119	167	197	270	298	299	386	560	667
			Med	74	112	153	170	233	259	266	343	498	623
			Min	62	97	137	151	186	226	238	303	440	572
	Water pressure drop	kPa	Max	1,2	3,5	10,2	12,3	17,3	4,8	15,6	15,3	18,2	27,3
			Med	1,2	5	8,7	9,5	13,3	6,6	12,7	12,2	14,8	24,2
			Min	0,9	3,9	7,3	7,7	8,9	5,2	10,3	9,9	11,9	20,8
Ventilation data													
Air flow rate	m ³ /h	Max	117	197	291	349	401	496	603	733	990	1493	
		Med	98	169	248	284	329	407	508	581	851	1368	
		Min	77	142	214	241	245	335	411	469	725	1217	
Acoustic data													
Sound power level	dB(A)	Max	38	40	43	40	42	43	49	53	57	62	
		Med	35	36	39	35	36	38	43	48	53	60	
		Min	29	30	36	32	34	33	37	43	47	57	
Sound pressure level	dB(A)	Max	29	31	34	31	33	34	40	44	48	53	
		Med	26	27	30	26	27	29	34	36	44	51	
		Min	20	21	27	23	25	24	28	31	38	48	
Electrical data													
Power input (standard motor)	W	Max	19	22	34	38	48	61	67	98	125	191	
		Med	16	18	29	30	39	50	52	81	103	181	
		Min	12	13	25	25	30	41	43	66	85	167	
Power input (EC motor)	W	Max	-	15	15	14	19	23	22	50	136	121	
		Med	-	12	10	10	14	17	17	37	108	97	
		Min	-	10	8	7	11	12	12	27	80	72	
Absorbed current	A	Max	0,09	0,1	0,15	0,17	0,21	0,28	0,29	0,45	0,55	0,87	
		Med	0,07	0,08	0,13	0,13	0,17	0,22	0,24	0,37	0,45	0,82	
		Min	0,05	0,06	0,11	0,11	0,13	0,18	0,2	0,31	0,37	0,77	



ARMONIA II

Chilled water cassettes



WATER



 1,5 - 10,8 kW
 1,9 - 13,5 kW
 225 - 1536 m³/h

LX^(A) 6^(B) 2^(C) 1^(D) NC^(E) EC^(F)

- (A) LX = Lennox
- (B) 6 = 600x600 - 9 = 900x900
- (C) 2 = 2 pipes - 3 = 2 pipes + electrical heater - 4 = 4 pipes
- (D) 1 = Size
- (E) Modbus card (suitable for infrared remote control) - NC = Not included - RC = Included
- (F) EC fan motor

600x600 - 2 pipe system

ARMONIA II			SPEED	621	622	623	624	625
Nominal thermal performances - Cooling mode								
❄️ COOLING MODE Water inlet temperature: 7°C Water outlet temperature: 12°C Air inlet temp.: 27°C DB / 19°C WB	Total cooling capacity	W	Max	2223	2667	4247	4975	5381
			Med	1835	2433	3047	3648	4655
			Min	1556	1944	2144	2697	3967
	Sensible cooling capacity	W	Max	1843	2027	3107	3695	3991
			Med	1485	1813	2177	2628	3355
			Min	1236	1424	1494	1907	2797
	Water flow rate	l/h	Max	390	465	739	867	939
			Med	321	424	530	635	812
			Min	271	338	372	468	691
	Water pressure drop	kPa	Max	20	16	24	24	30
			Med	14	14	18	18	24
			Min	11	10	11	16	18
Nominal thermal performances - Heating mode								
🔥 HEATING MODE Air temperature: 20°C Water inlet temp.: 45/40°C	Heating Capacity	W	Max	2340	2620	4080	4910	5420
			Med	1920	2370	2930	3440	4930
			Min	1590	1910	2090	2580	4090
	Water flow rate	l/h	Max	408	456	711	855	943
			Med	335	413	510	600	860
			Min	276	333	364	449	712
	Water pressure drop	kPa	Max	20,9	15,5	18,5	22,8	29,6
			Med	14,2	12,5	16,2	18	25,7
			Min	10,5	8,9	9,7	15,3	19,2
🔥 HEATING MODE Air temperature: 20°C Water inlet temp.: 50°C	Heating Capacity	W	Max	2800	3150	4910	5900	6500
			Med	2300	2850	3522	4150	5900
			Min	1900	2300	2510	3100	4900
	Water flow rate	l/h	Max	390	465	739	867	939
			Med	321	424	530	635	812
			Min	271	338	372	468	691
	Water pressure drop	kPa	Max	19	16	19	23,1	29
			Med	13	13	17	19,8	23
			Min	10	9	10	16,5	18
Ventilation data								
Air flow rate	m ³ /h	Max	367	398	550	660	760	
		Med	295	355	398	468	660	
		Min	225	269	269	328	550	
Acoustic data								
Sound power level	dB(A)	Max	46	44	52	60	62	
		Med	39	41	44	49	59	
		Min	33	34	34	39	56	
Sound pressure level	dB(A)	Max	37	35	43	51	53	
		Med	30	32	35	40	50	
		Min	24	25	25	30	44	
Electrical data								
Power input (standard motor)	W	Max	47	43	63	75	89	
Absorbed current (standard motor)	A	Max	0,22	0,19	0,28	0,33	0,39	
Power input (EC motor)	W	Max	12	11	25	52	69	
Absorbed current (EC motor)	A	Max	0,11	0,11	0,22	0,33	0,47	

LX^(A) 6^(B) 2^(C) 1^(D) NC^(E) EC^(F)

(A) LX = Lennox

(B) 6 = 600x600 - 9 = 900x900

(C) 2 = 2 pipes - 3 = 2 pipes + electrical heater - 4 = 4 pipes

(D) 1 = Size

(E) Modbus card (suitable for infrared remote control) - NC = Not included - RC = Included

(F) EC fan motor

600x600 - 4 pipe system

ARMONIA II			SPEED	641	642	643	644	645	646	
Nominal thermal performances - Cooling mode										
❄️ COOLING MODE	Water inlet temperature: 7°C Water outlet temperature: 12°C Air inlet temp.: 27°C DB / 19°C WB	Total cooling capacity	W	Max	2303	2707	3337	3827	3825	4395
				Med	1905	2373	2507	2957	3048	3408
				Min	1606	1864	1884	1974	2367	2627
		Sensible cooling capacity	W	Max	1873	1977	2547	2857	2975	3345
				Med	1505	1713	1867	2157	2308	2518
				Min	1226	1344	1364	1404	1747	1897
		Water flow rate	l/h	Max	403	472	584	668	669	767
				Med	333	414	438	515	532	594
				Min	280	324	328	343	412	456
		Water pressure drop	kPa	Max	18	14	17	22	21	28
				Med	15	12	14	19	17	22
				Min	10	10	10	15	12	17
Nominal thermal performances - Heating mode										
🔥 HEATING MODE	Air temperature.: 20°C Water inlet temp.: 45/40°C	Heating Capacity	W	Max	2690	3070	3900	2890	4380	3250
				Med	2300	2680	3070	2340	3510	2610
				Min	1780	2150	2150	1680	2760	2100
		Water flow rate	l/h	Max	236	269	342	254	384	285
				Med	201	235	269	206	307	229
				Min	156	187	189	147	242	184
		Water pressure drop	kPa	Max	12,2	20,4	14,4	18,1	17,5	21,2
				Med	11,3	16,5	11,9	14,9	15,1	18,8
				Min	8,8	12,2	7,1	11	9,6	13,3
🔥 HEATING MODE	Air temperature.: 20°C Water inlet temp.: 50°C	Heating Capacity	W	Max	3050	3500	4450	3300	5000	3710
				Med	2600	3050	3500	2670	4000	2980
				Min	2010	2450	2450	1910	3150	2390
		Water flow rate	l/h	Max	268	307	391	290	439	326
				Med	228	268	307	235	351	262
				Min	177	215	215	168	277	210
		Water pressure drop	kPa	Max	15	15	18	23	22	27
				Med	14	12	15	19	19	24
				Min	11	9	9	14	12	17
Ventilation data										
Air flow rate	m ³ /h	Max	367	398	550	550	660	660		
		Med	295	355	398	398	468	468		
		Min	224	269	269	269	328	328		
Acoustic data										
Sound power level	dB(A)	Max	46	47	52	52	58	58		
		Med	39	41	44	44	49	51		
		Min	33	37	34	37	39	44		
Sound pressure level	dB(A)	Max	37	38	43	43	49	49		
		Med	30	32	35	35	40	42		
		Min	24	28	25	28	30	35		
Electrical data										
Power input (standard motor)	W	Max	47	43	63	63	75	75		
Absorbed current (standard motor)	A	Max	0,22	0,19	0,28	0,28	0,33	0,33		
Power input (EC motor)	W	Max	12	12	25	29	38	52		
Absorbed current (EC motor)	A	Max	0,11	0,11	0,22	0,22	0,33	0,33		

LX_(A) 6_(B) 2_(C) 1_(D) NC_(E) EC_(F)

- (A) LX = Lennox
- (B) 6 = 600x600 - 9 = 900x900
- (C) 2 = 2 pipes - 3 = 2 pipes + electrical heater - 4 = 4 pipes
- (D) 1 = Size
- (E) Modbus card (suitable for infrared remote control) - NC = Not included - RC = Included
- (F) EC fan motor

900x900 - 2 pipe system and 4 pipe system

ARMONIA II			SPEED	2 PIPE SYSTEM			4 PIPE SYSTEM						
				921	922	923	941	942	943	944			
Nominal thermal performances - Cooling mode													
* COOLING MODE	Water inlet temperature: 7°C Water outlet temperature: 12°C Air inlet temp.: 27°C DB / 19°C WB	Total cooling capacity	W	Max	6128	9460	10865	6125	7100	8665	9965		
				Med	4950	6609	8790	4847	5139	6560	7510		
				Min	4152	4810	5336	4011	4257	4456	5056		
		Sensible cooling capacity	W	Max	4558	6400	7965	4505	5340	6635	7515		
				Med	3580	4339	6210	3497	3749	4880	5520		
				Min	2982	3457	3716	2851	3047	3186	3596		
		Water flow rate	l/h	Max	1064	1641	1888	1064	1236	1511	1734		
				Med	858	1144	1523	841	893	1142	1304		
				Min	719	923	923	695	738	772	876		
		Water pressure drop	kPa	Max	33,2	33,5	53	20,5	29,6	38	34		
				Med	22,9	13,5	36	13,5	18	24,5	21		
				Min	15,9	8,5	12,5	9,5	11,5	14	14		
Nominal thermal performances - Heating mode													
HEATING MODE	Air temperature: 20°C Water inlet temp.: 45/40°C	Heating Capacity	W	Max	6400	8610	11280	7940	9270	11030	8420		
				Med	5000	5970	8660	6180	7060	8380	6500		
				Min	4210	4590	5030	5130	5570	6010	4400		
		Water flow rate	l/h	Max	1115	1500	1964	697	812	967	739		
				Med	871	1039	1508	542	619	735	570		
				Min	734	800	876	449	488	527	386		
		Water pressure drop	kPa	Max	33,2	25	49,9	19,5	27,2	35,2	17,8		
				Med	22,9	10,8	30,7	13,2	16,9	23,9	12,1		
				Min	15,9	7,9	10,1	9,1	11,6	13,2	6,4		
		HEATING MODE	Air temperature: 20°C Water inlet temp.: 50°C	Heating Capacity	W	Max	7650	10400	13500	9000	10500	12500	9600
						Med	6000	7200	10400	7000	8000	9500	7400
						Min	5050	5550	6050	5800	6300	6800	5000
Water flow rate	l/h			Max	1064	1641	1888	791	922	1098	843		
				Med	858	1144	1523	615	703	835	650		
				Min	719	923	923	510	554	598	439		
Water pressure drop	kPa			Max	22	29	46	23,5	33	42,5	22		
				Med	16	12,5	31	16	20,5	29	15		
				Min	11	10	11	11	14	16	8		
Ventilation data													
Air flow rate	m ³ /h			Max	1023	1270	1536	1023	1270	1536	1536		
				Med	763	858	1175	763	858	1175	1175		
		Min	623	662	669	623	662	669	669				
Acoustic data													
Sound power level	dB(A)	Max	47	53	59	47	53	59	59				
		Med	39	40	49	39	40	52	49				
		Min	32	34	35	32	34	38	35				
Sound pressure level	dB(A)	Max	38	44	50	38	44	50	50				
		Med	30	31	40	30	31	40	40				
		Min	23	25	26	23	25	26	26				
Electrical data													
Power input (standard motor)	W	Max	72	100	135	75	100	135	135				
Absorbed current (standard motor)	A	Max	0,52	0,6	0,75	0,52	0,6	0,75	0,75				
Power input (EC motor)	W	Max	55	62	151	31	43	118	118				
Absorbed current (EC motor)	A	Max											

600x600

ARMONIA II		2 PIPE SYSTEM					4 PIPE SYSTEM					
		621	622	623	624	625	641	642	643	644	645	646
Dimensions with cabinet												
A1	mm	575	575	575	575	575	575	575	575	575	575	575
B1		575	575	575	575	575	575	575	575	575	575	575
C1		286	286	286	286	286	286	286	286	286	286	286
Dimensions without cabinet												
A	mm	680	680	680	680	680	680	680	680	680	680	680
B		680	680	680	680	680	680	680	680	680	680	680
C		40	40	40	40	40	40	40	40	40	40	40
Weight of standard units												
Basic unit	kg	20	21	23	24	24	23	24	24	24	24	24

900x900

ARMONIA II		2 PIPE SYSTEM			4 PIPE SYSTEM			
		921	922	923	941	942	943	944
Dimensions with cabinet								
A1	mm	818	818	818	818	818	818	818
B1		818	818	818	818	818	818	818
C1		326	326	326	326	326	326	326
Dimensions without cabinet								
A	mm	900	900	900	900	900	900	900
B		900	900	900	900	900	900	900
C		55	55	55	55	55	55	55
Weight of standard units								
Basic unit	kg	40	45	45	41	46	46	46

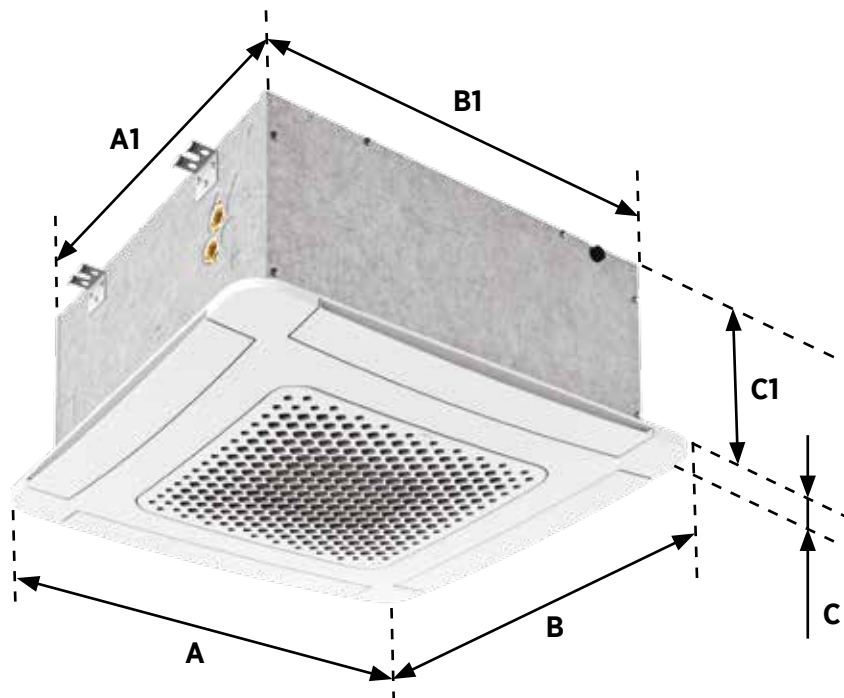



COMFAIR II HD

High wall fan coil units



WATER



 **1,3 - 3,8 kW**
 **1,5 - 4,3 kW**
 **250 - 780 m³/h**

HD^(A) 2^(B)

(A) HD = High pressure fan coil unit
(B) 1 = Unit size

COMFAIR II HD		SPEED	1	2	3	4	
Nominal thermal performances - Cooling mode							
* COOLING MODE Water inlet temperature: 7°C Water outlet temperature: 12°C Air inlet temp.: 27°C DB / 19°C WB	Total cooling capacity	W	Max	1931	2351	3292	3949
			Med	1704	2073	2918	3595
			Min	1525	1805	2385	2885
	Sensible cooling capacity	W	Max	1520	1871	2632	3079
			Med	1330	1613	2278	2805
			Min	1170	1385	1855	2225
	Water flow rate	l/h	Max	337	409	573	687
			Med	297	360	508	625
			Min	266	314	415	501
	Water pressure drop	kPa	Max	15,9	22,9	17,4	21,6
			Med	12,5	18,3	13,3	17,8
			Min	10,0	14,3	11,4	11,8
Nominal thermal performances - Heating mode							
* HEATING MODE Air temperature: 20°C Water inlet temp.: 45/40°C	Heating Capacity	W	Max	2310	2490	3480	4290
			Med	1940	2290	2750	3570
			Min	1480	1610	1810	2810
	Water flow rate	l/h	Max	397	428	599	738
			Med	334	394	473	614
			Min	255	277	311	483
	Water pressure drop	kPa	Max	12,4	20,0	31,2	56,8
			Med	9,2	18,3	19,7	41,8
			Min	5,7	9,5	9,4	27,9
Ventilation data							
Air flow rate	m ³ /h	Max	464	462	639	778	
Med		356	406	476	598		
Min		252	262	294	448		
Acoustic data							
Sound power level	dB(A)	Max	49	51	49	55	
		Med	42	49	42	50	
		Min	34	40	31	45	
Sound pressure level	dB(A)	Max	40	42	40	46	
		Med	34	40	33	41	
		Min	25	31	22	36	
Asynchronous motor							
Motor fan absorbed power	W	Max	23	24	30	46	
		Med	18	21	22	27	
		Min	13	13	13	20	
Power supply	- 230V / 1ph / 50-60Hz wired speed						
ECM motor							
Motor fan absorbed power	W	Max	14	14	16	25	
		Med	9	12	9	15	
		Min	6	7	5	9	
Speed control voltage (Vdc)	V	Max	7,6	7,9	6,6	9,2	
		Med	5,3	6,7	4,0	6,4	
		Min	3,0	3,4	1,3	4,1	
Power supply	- 230V / 1ph / 50-60Hz wired speed						
Working limits							
Indoor air temperature	min. 15°C - max 30°C						
Indoor humidity	max 63 %						
Max water pressure	8 Bar						
Max inlet pressure	70°C						
Min inlet water temperature	6°C						
Minimum temperature water outlet	11°C						

Standard unit with free outlet: external static pressure = 0 Pa / The sound power level test has been performed according to EN 16583:2015 standard / **Sound pressure level:** 8,6 dB(A) lower that the sound power level for a room of 90 m³ with a reverberation time of 0,5 sec. / **Supported power supply:** -230V / 1ph / 50Hz

Heating: To avoid stratification of the ambient air, it is recommended not to supply the unit with a water temperature above 65 ° C.

Cooling: In environments with high relative humidity, condensation may form on the outside of the unit and on the air delivery. These phenomena can damage the underlying objects and the floor; to avoid them, it is always recommended to install the valve and, with the fan in operation, to respect the minimum and medium supply temperature limits indicated (values referring to the minimum wired speed).

COMFAIR II HD		1	2	3	4
A	mm	930	930	1235	1170
B		185	185	185	185
C		323	323	323	323
D		850	850	1155	1155
Weight of standard units					
Basic unit	kg	11,5	12	14	14,5

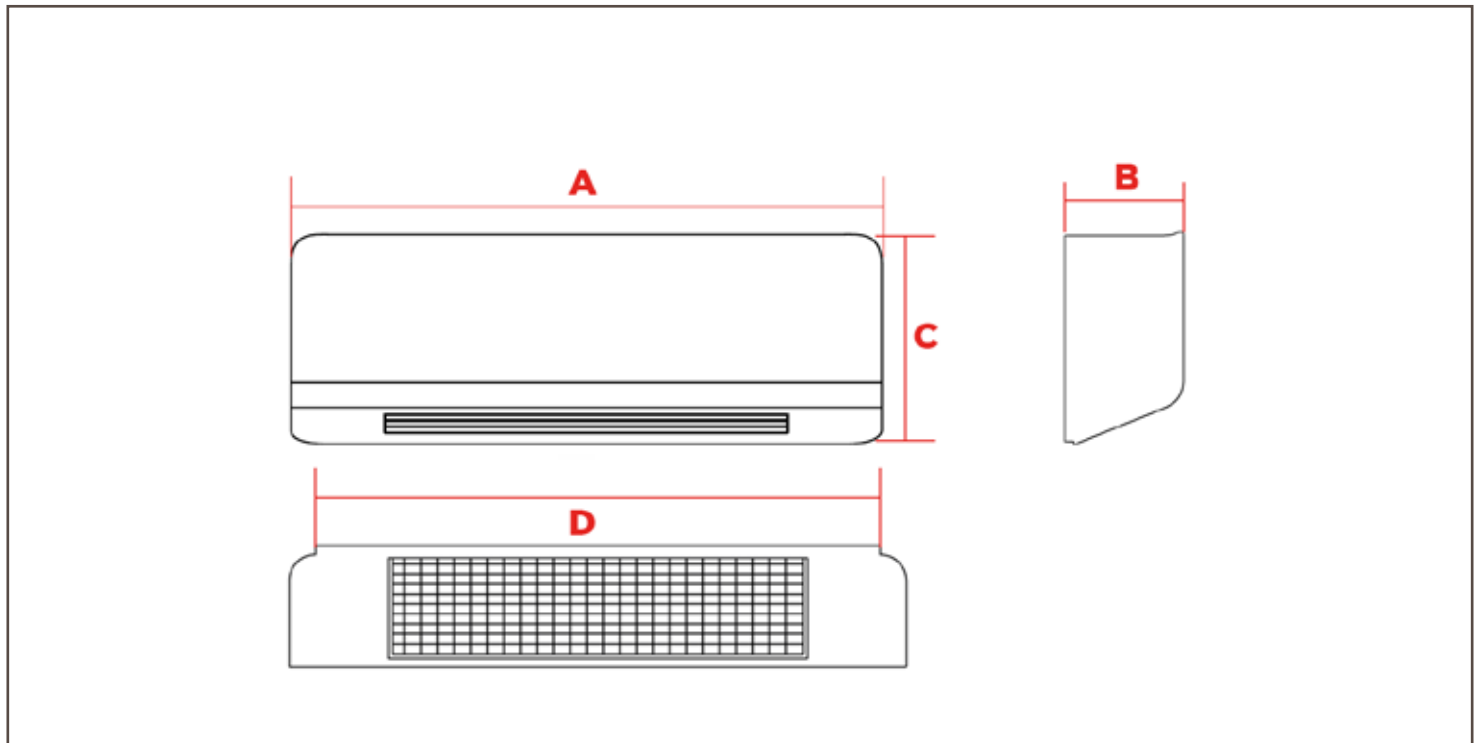

INALTO

Ductable Fan Coil Unit



WATER



 **3 - 28 kW**
 **3,7 - 37,7 kW**
 **516 - 5668 m³/h**



The size 49 and 59 are not certified Eurovent due to Airflow Limit

A_(A) 05_(B) R_(C) H_(D) DS_(E)

- (A) **A** = 3-speed AC fan - **E** = EC fan
- (B) **05** = Size
- (C) Hydraulic connections - **R** = Right - **L** = Left
- (D) **H** = Horizontal installation - **V** = Vertical installation
- (E) **DS** = Double skin

4 pipe system (4R+2 coils)

INALTO				SPEED	05	11	15	25	28	49	57		
Nominal thermal performances - Cooling mode													
* COOLING MODE	Water inlet temperature.: 7°C Water outlet temperature.: 12°C Air inlet temp.: 27°C DB / 19°C WB	Total cooling capacity	W	Max	3010	5728	8786	10924	14511	23350	26171		
				Med	2896	5634	7725	8970	13009	21768	23958		
				Min	2662	5408	6896	6550	11620	17549	21520		
		Sensible cooling capacity	W	Max	2136	4138	6326	7864	10581	17320	19401		
				Med	2047	4064	5505	6370	9389	16038	17608		
				Min	1876	3888	4876	4590	8320	12689	15650		
		Water flow rate	l/h	Max	536	1009	1551	1934	2589	4167	4687		
				Med	513	991	1363	1586	2318	3878	4282		
				Min	471	952	1217	1158	2071	3117	3845		
		Water pressure drop	kPa	Max	9,9	13,3	17,8	17	19,5	20,2	26,4		
				Med	9,1	12,9	14,2	12	16,1	18,4	22,2		
				Min	7,9	12	11,6	6,9	13,2	12,1	18,8		
Nominal thermal performances - Heating mode													
HEATING MODE	Air temperature.: 20°C Water inlet temp.: 65/55°C	Heating Capacity	W	Max	4080	7580	11380	14150	19040	31190	34360		
				Med	3930	7460	10070	11760	17130	29080	31460		
				Min	3630	7180	9080	8770	15400	23600	28360		
		Water flow rate	l/h	Max	358	665	997	1242	1669	2735	3012		
				Med	345	654	883	1031	1502	2550	2758		
				Min	321	630	797	769	1351	2069	2486		
		Water pressure drop	kPa	Max	12,7	16,6	11,4	7,9	15,2	33,5	22,8		
				Med	11,9	16,1	9,2	5,7	12,7	29,6	19,6		
				Min	10,3	15,1	7,7	3,4	10,5	20,5	16,3		
		HEATING MODE	Air temperature.: 20°C Water inlet temp.: 70/60°C	Heating Capacity	W	Max	4610	8560	12860	16030	21520	35230	38850
						Med	4430	8420	11380	13300	19360	32840	35570
						Min	4100	8110	10260	9910	17410	26640	32050
Water flow rate	l/h			Max	405	752	1130	1408	1890	3095	3413		
				Med	390	740	1000	1169	1702	2885	3124		
				Min	362	712	901	870	1529	2341	2815		
Water pressure drop	kPa			Max	15,5	20,3	13,9	9,8	18,6	40,8	27,9		
				Med	14,5	19,7	11,2	6,9	15,5	36,1	23,9		
				Min	12,6	18,4	9,4	4,1	12,8	25	19,9		

A_(A) 05_(B) R_(C) H_(D) DS_(E)

- (A) **A** = 3-speed AC fan - **E** = EC fan
- (B) **05** = Size
- (C) Hydraulic connections - **R** = Right - **L** = Left
- (D) **H** = Horizontal installation - **V** = Vertical installation
- (E) **DS** = Double skin

INALTO			SPEED	05	11	15	25	28	49	57
Ventilation data										
Air flow rate	m ³ /h	Max	484	966	1478	1868	2651	4598	5187	
		Med	459	944	1245	1437	2275	4144	4548	
		Min	413	894	1079	963	1956	3062	3904	
Acoustic data										
INALTO SINGLE SKIN UNIT	Sound power level	dB(A)	Max	61	65	66	67	71	74	75
			Med	59	64	60	59	66	70	69
			Min	55	64	54	56	62	61	65
	Sound pressure level	dB(A)	Max	52	56	57	58	62	65	66
			Med	50	55	51	50	57	61	60
			Min	46	55	45	47	53	52	56
INALTO-DS DOUBLE SKIN UNIT	Sound power level	dB(A)	Max	61	64	66	67	71	74	75
			Med	59	63	60	58	66	70	69
			Min	55	64	57	53	62	61	65
	Sound pressure level	dB(A)	Max	52	55	57	58	62	65	66
			Med	50	54	51	49	57	61	60
			Min	46	55	48	44	53	52	56
Electrical data										
Power input (standard motor)	W	Max	94	149	224	346	529	860	1059	
		Med	82	144	195	270	461	762	922	
		Min	73	138	174	200	410	561	820	
Absorbed current (standard motor)	A	Max	0,45	0,64	1,08	1,67	2,56	4,15	5,11	
		Med	0,4	0,61	0,94	1,29	2,23	3,68	4,46	
		Min	0,35	0,59	0,84	0,95	1,98	2,71	3,96	
Power input (EC motor)	W	Max	69	109	156	240	379	639	773	
		Med	58	99	95	115	232	464	464	
		Min	35	82	66	45	158	206	309	
Absorbed current (EC motor)	A	Max	0,52	0,87	1,16	1,13	1,75	2,93	3,5	
		Med	0,48	0,75	0,71	0,65	1,18	2,27	2,37	
		Min	0,37	0,63	0,52	0,41	0,82	1,24	1,65	

Horizontal unit

INALTO		SINGLE SKIN							DOUBLE SKIN						
		05	11	15	25	28	49	57	05	11	15	25	28	49	57
A	mm	770	1070	1270	1420	1520	2190	2190	793	1093	1293	1443	1543	2233	2233
B		297	297	347	372	397	373	398	325	325	375	400	425	401	426
C		643	643	643	770	770	770	770	643	643	643	770	770	770	770
Weight of standard units															
Basic unit	kg	29	40	51	65	76	133	141	43	59	71	92	101	167	175

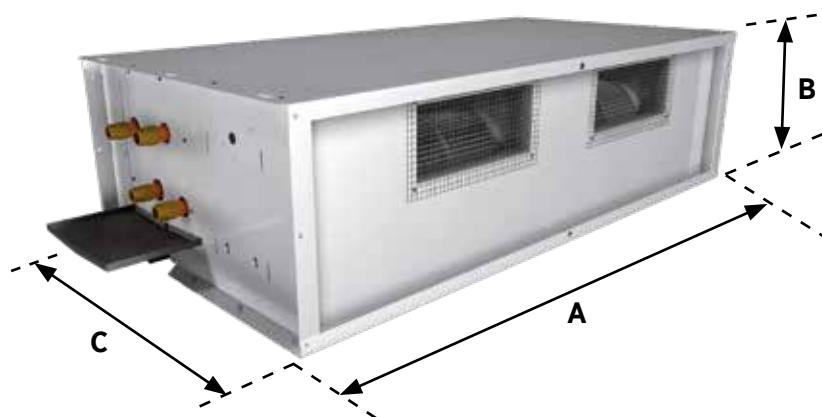

Vertical unit

INALTO		SINGLE SKIN							DOUBLE SKIN						
		05	11	15	25	28	49	57	05	11	15	25	28	49	57
A1	mm	770	1070	1270	1420	1520	2190	2190	793	1093	1293	1443	1543	2213	2213
B1		740	740	815	890	915	891	916	754	754	829	904	929	905	930
C1		347	347	397	422	447	423	448	367	367	417	442	467	443	468
Weight of standard units															
Basic unit	kg	33	47	60	69	76	136	145	49	66	84	99	108	181	191

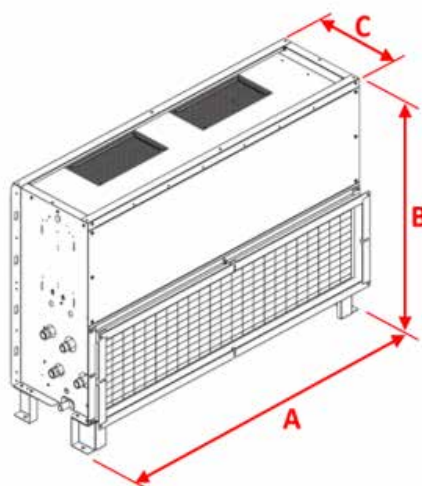





COMFAIR HH/HV

High pressure fan coil units

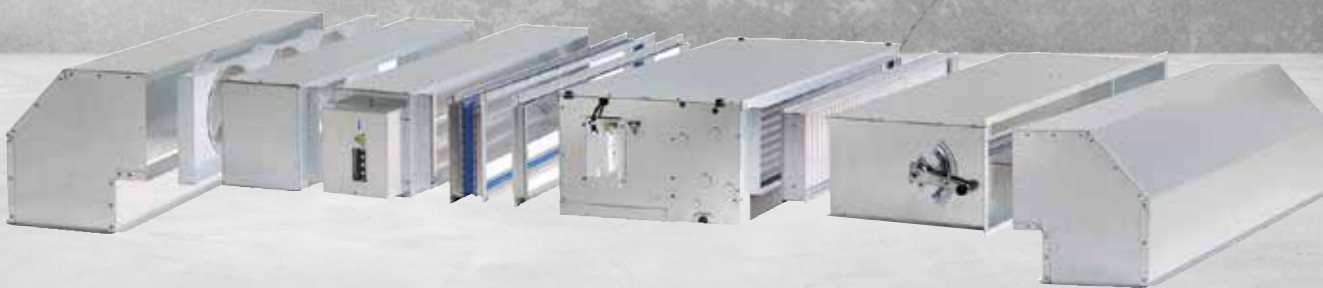

WATER



 **2,8 - 50,6 kW**
 **4,9 - 60 kW**
 **840 - 8000 m³/h**

HH_(A) 20_(B)

(A) HH = Horizontal installation - HV = Vertical installation
 (B) 20 = Unit size

2 PIPE SYSTEM

COMFAIR HH/HV			SPEED	10	20	30	40	50	60	70	
Nominal thermal performances - Cooling mode											
* COOLING MODE	Water inlet temperature: 7°C Water outlet temperature: 12°C Air inlet temp.: 27°C DB / 19°C WB	Total cooling capacity	W	Max	2735	4974	6936	8277	10850	23488	42068
				Med	2683	4711	6797	8066	9764	21629	39655
				Min	2543	4084	6536	7596	8081	19816	35610
		Sensible cooling capacity	W	Max	2025	3684	5216	6187	8250	16918	30788
				Med	1983	3471	5107	6016	7334	15469	28875
				Min	1873	2964	4856	5626	5971	14096	25670
		Water flow rate	l/h	Max	487	875	1225	1459	1936	4200	7550
				Med	479	828	1197	1418	1736	3858	7081
				Min	454	720	1143	1336	1438	3517	6352
		Water pressure drop	kPa	Max	13,5	24,5	28,3	27,7	23,9	34,4	36,4
				Med	13,1	22,2	27,2	26,3	19,7	29,6	32,5
				Min	12,0	17,4	25,0	23,7	14,1	25,1	26,9
Nominal thermal performances - Heating mode											
* HEATING MODE	Air temperature: 20°C Water inlet temp.: 45/40°C	Heating Capacity	W	Max	3080	5370	7660	9040	12430	25450	46880
				Med	3030	5060	7470	8760	11010	23210	43630
				Min	2860	4350	7100	8210	8960	20970	38670
		Water flow rate	l/h	Max	537	936	1335	1575	2165	4433	8166
				Med	527	881	1301	1526	1918	4042	7604
				Min	498	758	1237	1430	1562	3652	6736
		Water pressure drop	kPa	Max	13,2	22,7	27,1	26,1	24,0	31,1	34,5
				Med	12,8	20,5	25,9	24,7	19,4	26,5	30,4
				Min	11,6	15,7	23,7	22,0	13,5	22,1	24,5
* HEATING MODE	Air temperature: 20°C Water inlet temp.: 50°C	Heating Capacity	W	Max	3660	6410	9120	10770	14730	30440	55840
				Med	3600	6030	8890	10440	13070	27750	52020
				Min	3400	5200	8450	9790	10670	25100	46190
		Water flow rate	l/h	Max	487	875	1225	1459	1936	4200	7550
				Med	479	828	1197	1418	1736	3858	7081
				Min	454	720	1143	1336	1438	3517	6352
		Water pressure drop	kPa	Max	11,0	20,0	23,1	22,5	19,4	28,0	29,7
				Med	10,7	18,1	22,1	21,4	16,0	24,1	26,5
				Min	9,7	14,2	20,4	19,3	11,5	20,5	21,9
Ventilation data											
Air flow rate	m ³ /h	Max	541	944	1419	1323	2401	4134	7985		
		Med	528	873	1371	1276	2041	3676	7279		
		Min	491	721	1282	1200	1560	3242	6246		
Acoustic data											
Sound power level (inlet + radiated)	dB(A)	Max	58	62	63	65	71	70	72		
		Med	57	59	62	64	67	66	67		
		Min	56	56	60	62	61	61	62		
Sound power level (outlet)	dB(A)	Max	61	63	66	66	70	74	75		
		Med	60	60	65	65	66	69	70		
		Min	58	56	62	63	60	64	65		
Sound pressure level (inlet + radiated)	dB(A)	Max	49	53	54	56	58	61	63		
		Med	48	50	53	55	59	57	58		
		Min	47	47	51	53	53	52	53		
Sound pressure level (outlet)	dB(A)	Max	52	54	57	57	57	65	66		
		Med	51	51	56	56	58	60	61		
		Min	49	47	53	54	54	55	56		
Electrical data											
Power input (standard motor)	W	Max	105	126	204	223	430	992	1932		
		Med	107	119	173	194	366	861	1615		
		Min	107	116	164	184	299	684	1410		
Absorbed current (standard motor)	A	Max	0,51	0,59	1,12	1,18	1,90	4,52	9,00		
		Med	0,51	0,55	0,87	0,96	1,67	3,95	7,90		
		Min	0,49	0,54	0,79	0,92	1,45	3,25	6,50		
Power input (ECM motor)	W	Max	81	112	161	172	345	650	1180		
		Med	75	92	145	151	224	450	880		
		Min	63	58	124	122	117	300	540		
Absorbed current (ECM motor)	A	Max	0,60	0,88	1,02	1,08	1,60	2,70	5,40		
		Med	0,58	0,75	0,90	0,96	1,05	1,83	3,70		
		Min	0,47	0,50	0,77	0,78	0,65	1,20	2,20		

HH^(A) 20^(B)

(A) HH = Horizontal installation - HV = Vertical installation

(B) 20 = Unit size

4 PIPE SYSTEM

COMFAIR HH/HV			SPEED	10	20	30	40	50	60	70	
Nominal thermal performances - Cooling mode											
* COOLING MODE	Water inlet temperature: 7°C Water outlet temperature: 12°C Air inlet temp.: 27°C DB / 19°C WB	Total cooling capacity	W	Max	2665	4854	6776	8117	10650	22958	40818
			Med	2623	4631	6657	7926	9644	21409	38985	
			Min	2493	4044	6376	7506	8031	19636	35350	
		Sensible cooling capacity	W	Max	1975	3584	5076	6047	8080	16498	29758
				Med	1933	3411	4987	6010	7244	15299	28335
				Min	1833	2944	4756	5910	5931	13956	25470
		Water flow rate	l/h	Max	475	855	1198	1431	1900	4109	7335
				Med	468	815	1172	1394	1718	3820	6966
				Min	446	714	1123	1320	1430	3487	6308
	Water pressure drop	kPa	Max	13,0	23,5	27,2	26,7	23,1	33,1	34,6	
			Med	12,6	21,6	26,2	25,5	19,3	29,1	31,6	
			Min	11,6	17,1	24,3	23,2	14,0	24,8	26,5	
Nominal thermal performances - Heating mode											
* HEATING MODE	Air temperature: 20°C Water inlet temp.: 65/55°C	Heating Capacity	W	Max	2560	4360	6130	7240	9810	29570	52860
			Med	2530	4180	6010	7070	8930	27580	50280	
			Min	2420	3710	5770	6730	7560	25290	45700	
		Water flow rate	l/h	Max	225	383	537	635	860	2593	4634
				Med	222	366	526	619	783	2418	4408
				Min	212	326	506	590	663	2217	4006
	Water pressure drop	kPa	Max	18,3	9,7	21,0	10,8	21,7	20,8	22,3	
			Med	17,9	9,0	20,3	10,4	18,4	18,0	20,4	
			Min	16,6	7,3	18,9	9,5	13,7	15,5	17,3	
* HEATING MODE	Air temperature: 20°C Water inlet temp.: 70/60°C	Heating Capacity	W	Max	2900	4940	6930	8200	11110	33410	59740
			Med	2860	4730	6800	8010	10110	31150	56820	
			Min	2740	4210	6530	7620	8560	28560	51630	
		Water flow rate	l/h	Max	255	434	609	720	976	2935	5247
				Med	251	416	597	703	888	2737	4990
				Min	240	369	574	670	752	1509	4536
Water pressure drop	kPa	Max	22,4	11,9	25,7	13,3	26,6	24,9	27,2		
		Med	21,9	11,0	24,8	12,7	22,6	22,0	24,9		
		Min	20,2	8,9	23,2	11,7	16,8	18,9	21,1		
Ventilation data											
Air flow rate	m ³ /h	Max	523	914	1372	1595	2335	4009	7657		
		Med	512	855	1330	1536	2010	3627	7112		
		Min	478	713	1249	1422	1547	3206	6186		
Acoustic data											
Sound power level (inlet + radiated)	dB(A)	Max	58	62	63	65	67	70	72		
		Med	57	59	62	64	68	66	67		
		Min	59	56	60	62	62	61	62		
Sound power level (outlet)	dB(A)	Max	61	60	66	66	66	74	75		
		Med	61	60	65	65	67	69	70		
		Min	63	56	62	63	63	64	65		
Sound pressure level (inlet + radiated)	dB(A)	Max	49	53	54	56	58	61	63		
		Med	48	50	53	55	59	57	58		
		Min	47	47	51	53	53	52	53		
Sound pressure level (outlet)	dB(A)	Max	52	51	57	57	57	65	66		
		Med	51	51	56	56	58	60	61		
		Min	49	47	53	54	54	55	56		
Electrical data											
Power input (standard motor)	W	Max	105	126	204	223	430	992	1932		
		Med	107	119	173	194	366	861	1615		
		Min	107	116	164	184	299	684	1410		
Absorbed current (standard motor)	A	Max	0,51	0,59	1,12	1,18	1,90	4,52	9,00		
		Med	0,51	0,55	0,87	0,96	1,67	3,95	7,90		
		Min	0,49	0,54	0,79	0,92	1,45	3,25	6,50		
Power input (ECM motor)	W	Max	79	110	158	169	341	650	1180		
		Med	73	92	143	149	226	450	880		
		Min	63	59	123	122	121	300	540		
Absorbed current (ECM motor)	A	Max	0,60	0,88	1,02	1,08	1,60	2,70	5,40		
		Med	0,58	0,75	0,90	0,96	1,05	1,83	3,70		
		Min	0,47	0,50	0,77	0,78	0,65	1,20	2,20		

Horizontal unit

COMFAIR HH		10	20	30	40	50	60	70
A	mm	740	1090	1190	1430	1430	1480	2170
B		533	533	533	533	533	853	853
C		300	300	325	325	375	675	675
Weight of standard units								
Basic unit	kg	25	33	38	44	53	121	192

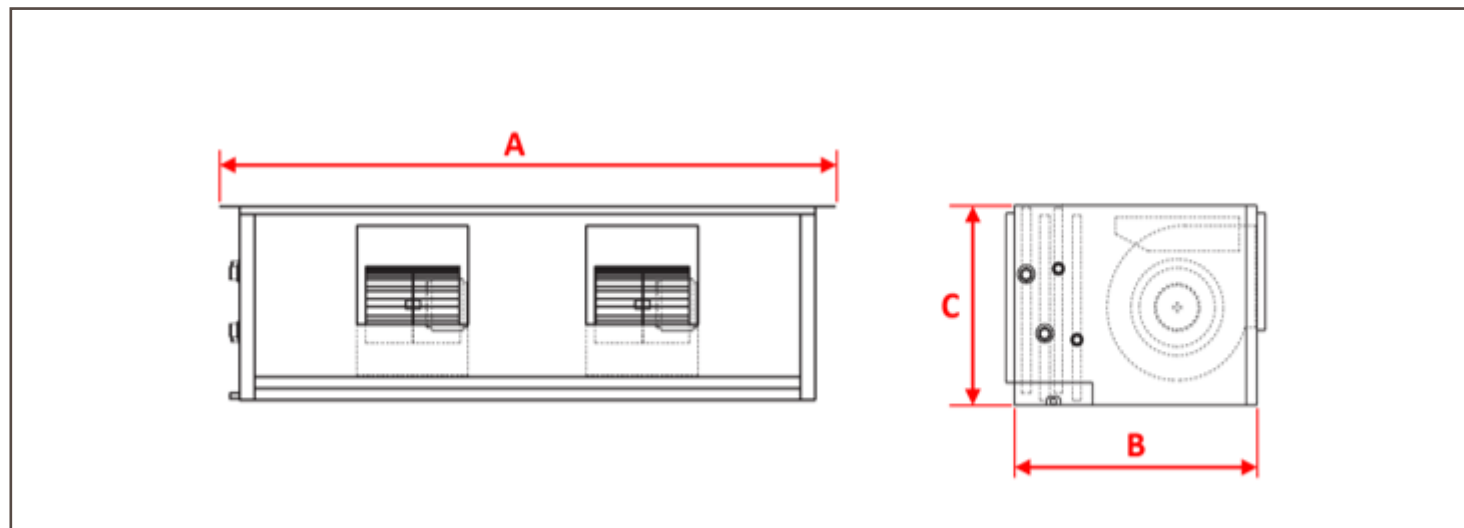

Vertical unit

COMFAIR HV		10	20	30	40	50	60	70
A	mm	740	1090	1190	1430	1430	1480	2170
B		300	300	325	325	375	672	672
C		573	573	643	643	693	1265	1265
Weight of standard units								
Basic unit	kg	27	35	41	46	56	117	192

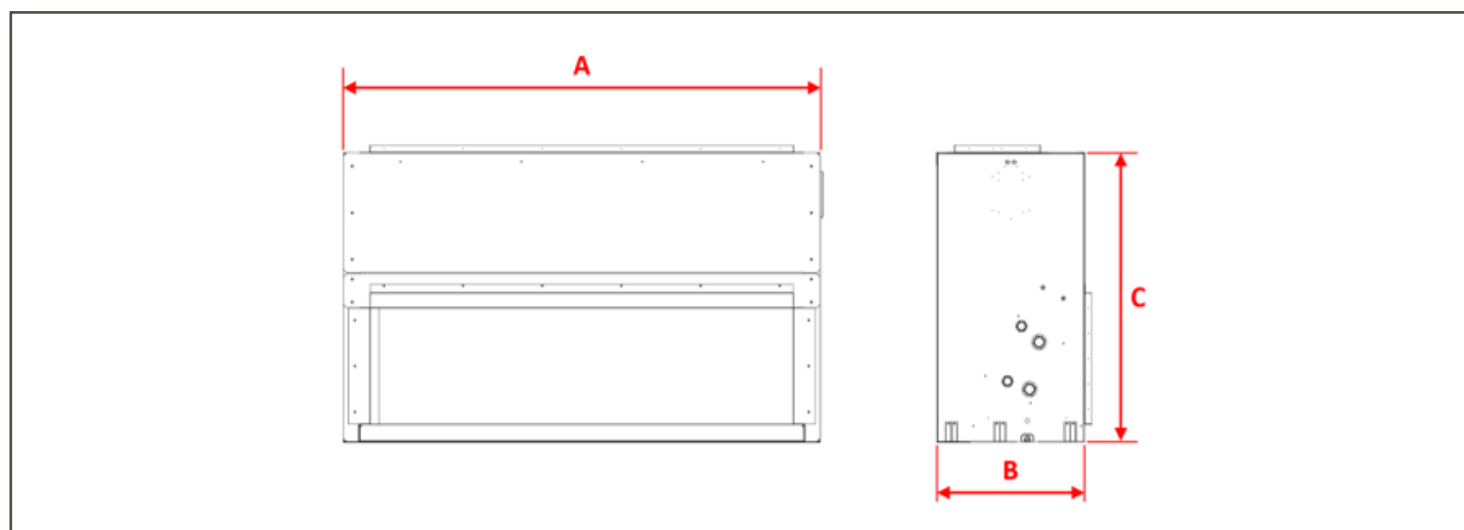

UNITS HEATERS



AXIL/EQUITHERM

195



















AXIL EC /
AXIL F EC

199



UNITS HEATERS

 AIR COOLED

		Axil / Equitherm	 	 4 - 20 kW  12 - 105 kW  1600 - 9100 m³/h		-
		Axil EC/ Axil F EC	 	 4 - 22 kW  3 - 44 kW  740 - 7085 m³/h		-

 Water/Air

 Cooling capacity

 Heating capacity

 Airflow rate

 Non food retail

 Shopping malls

 Office buildings

 Hotels

 Industry

Cooling capacity

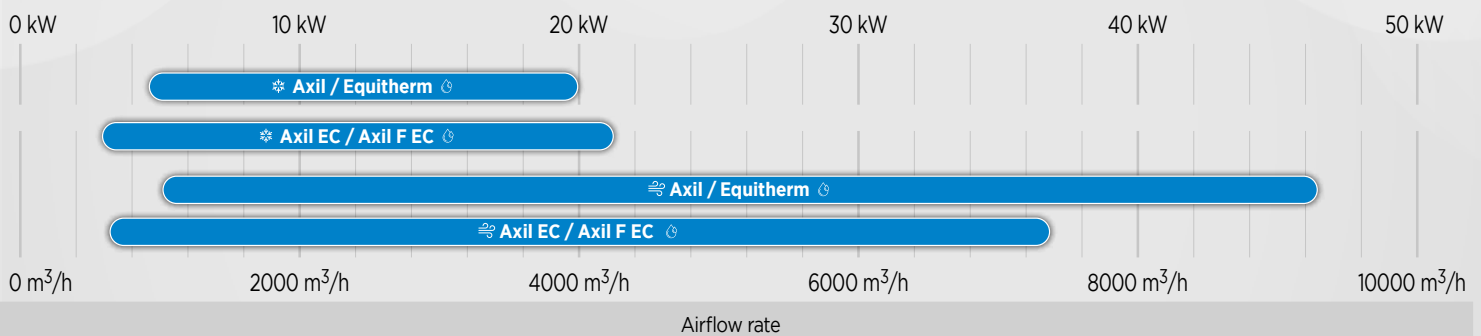



AXIL/EQUITHERM

Unit heaters / Destratification fans



WATER



 **4 - 20 kW**
 **12 - 105 kW**
 **1600 - 9100 m³/h**

AXIL_(A) 4_(B) 02_(C) 4_(D)

(A) **AXIL** = Hot water - **AXIL F** = Hot/chilled water - **AXIL V** = High temperature water/steam - **AXIL Z** = Electrical heater - **EQUITHERM** = Destratifier
 (B) Cabinet size - **4** = 526 - **5** = 636 - **6** = 743 - **9** = 1011
 (C) **AXIL/AXIL F/AXIL V** = Number of rows - 2R, 3R, 4R - **AXIL Z** = Electrical heater capacity 14kW/24kW/39kW - **EQUITHERM** = 4-pole or 6-pole motor
 (D) **AXIL/AXIL F/AXIL V** - 4 = 4/6-pole motor - 6 = 6/8-pole motor = - **AXIL Z** - R = control power fitted on (for thermostat control)

AXIL

AXIL F

Cooling and Heating:
 Hot water maximum 120°C / 16 bars
 Minimum Chilled water inlet 7°C
 Airflow : 2000 to 9500 m³/h
 Cooling capacity (Air 26°C/55% - Water 7/12°C) : 4 to 22,4 kW
 4 Sizes - 4/5/6/9

AXIL V

Heating only:
 Hot water, Superheated water or Steam
 Maximum 210°C / 20 bars
 Airflow : 2100 to 9200 m³/h
 Heating capacity (Air 18°C - Steam 15bars) : 31 to 151 kW
 4 Sizes - 4/5/6/9

AXIL Z

Heating (electrical heater)
 Airflow : 1560 to 4790 m³/h
 Heating capacity : 14 / 24 / 39 kW
 3 Sizes - 4/5/6

EQUITHERM

Ventilation only
 Airflow : 1700 to 13000 m³/h
 4 Sizes - 4/5/6/9

For full technical data pls. consult the Technical Document AGU.



AXIL		AXIL (HOT WATER)				AXIL F (HOT/CHILLED WATER)				AXIL V (HIGH TEMPERATURE WATER/STEAM)			
		4	5	6	9	4	5	6	9	4	5	6	9
A	mm	526	636	743	1011	526	636	743	1011	526	636	743	1011
B		526	636	743	1011	537	647	754	1022	526	636	743	1011
C		468	468	468	576	468	468	468	576	468	468	468	576
D		69	69	60	92	69	69	60	92	69	69	60	92
E*		-	-	-	-	542	650	758	1026	-	-	-	-
F*		-	-	-	-	450	450	450	450	-	-	-	-
Weight of standard units													
2R	kg	22	25	34	81	22	25	34	81	22	25	34	81
3R		23	28	39	90	23	28	39	90	23	28	39	90
4R		25	32	45	100	25	32	45	100	25	32	45	100
Steam		-	-	-	-	-	-	-	-	30	38	51	92

* Drain pan only available on chilled water version (AXIL F).

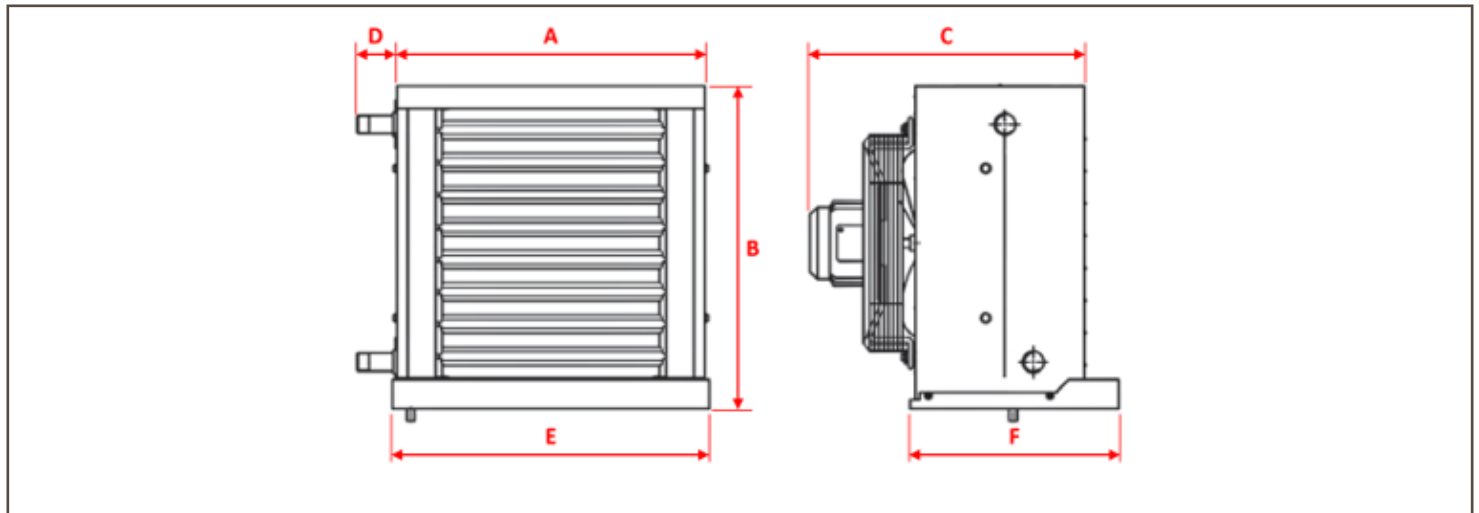

AXIL		AXIL Z (ELECTRICAL HEATER)			EQUITHERM (DESTRATIFIER)			
		4	5	6	4	5	6	9
A	mm	525	633	741	525	633	741	1009
B		526	636	743	526	636	743	1011
C		515	515	515	515	515	515	532
Weight of standard units								
Base unit	kg	22	30	38	14	20	25	42

* Electrical box only available on AXIL Z.

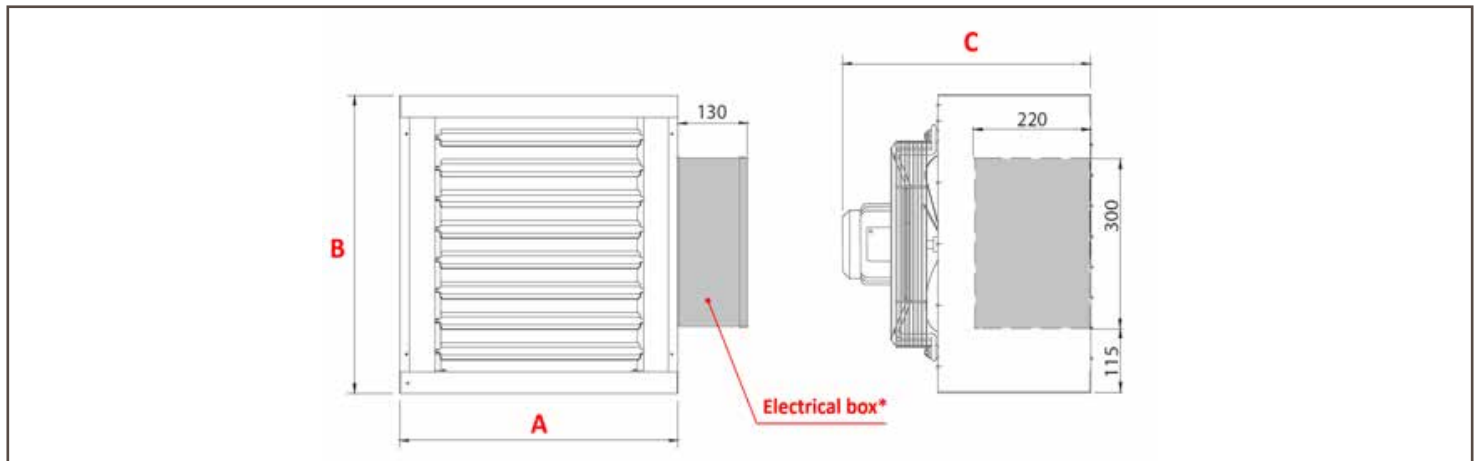

AXIL EC / AXILF EC

Unit heaters



WATER



 4 - 22 kW
 3 - 44 kW
 740 - 7085 m³/h

AXIL EC_(A) 4_(B) 02_(C) 4_(D)

- (A) **AXIL EC** = Hot water - **AXIL F EC** = Hot/chilled water
 (B) Cabinet size - **4** = 526 - **5** = 636 - **6** = 743 - **9** = 1011
 (C) **AXIL EC/AXIL F EC** = Number of rows - 2R, 3R, 4R
 (D) **AXIL EC /AXIL F EC** - 4 = 4/6-pole motor - 6 = 6/8-pole motor

AXIL EC

Heating:

Airflow : 740-7085 m³/h
 Heating Capacity : 3,43 – 43,53 kW
 Entering air temperature 15°; WT=45/40°C

AXIL F EC

Heating:

Airflow : 740-7085 m³/h
 Heating Capacity : 3,43 – 43,53 kW
 Entering air temperature 15°; WT=45/40°C

Cooling:

Airflow : 700 - 5275 m³/h
 Heating Capacity : 2,79 – Kw 22,19 kW
 Airflow : 2100 to 9200 m³/h
 Entering air temperature 26°; WT 7/12°C - ΔT=5°; R.H.: 55 %

MAIN COMPONENTS

Motor ventilator made up of 3 elements:

- fan
- motor
- finger proof guard also acts as the main support and fixing frame.

This galvanized steel frame is mounted into the main casing via residually anti-vibration rubber mountings.

CASING

The casing is manufactured from galvanized prepainted steel finished in a light grey colour (RAL 9002).

The adjustable louvres are held firm by spring loaded pivots.

Fourway distribution is achieved by the addition of a second of the unit generally for downward application.

HELICOIDAL FAN

The fan, made of plastic material with glass reinforced plastic for the sizes 2-4-6 and of aluminium for the size 9, has a high-capacity profile that provides the maximum air volume with the minimum energy consumption. The finger proof guard is painted with electroplating treatment, that ensures more protection against corrosion.

The air flow is uniformly distributed through the whole coil and consequently the unit is very quiet.

COIL

Heating and cooling :

- copper tubes
- aluminium fins

For Cooling only: the heat exchanger is not suitable for use in corrosive atmospheres or in environments where aluminium may be subject to corrosion.

EXCEPTIONAL DURABILITY

With a lifespan of around **20 years** this heater epitomizes **durability & reliability**.

ELECTRONIC MOTOR

Single phase permanent magnet brushless electronic motor, IP 44 protection and class B insulation. It is controlled with reconstructed current according to a sinusoidal wave.

The inverter board that controls the motor operation is powered by 230 Volt, single-phase and, with a switching system, it generates a three-phase frequency modulated, wave form power supply.

The electric power supply required for the machine is therefore single-phase with voltage of **230 - 240 V** and frequency of **50 - 60 Hz**

UNPARALLELED VERSATILITY

This Unit Heater can work also with low water temperature in heating mode, therefore it adapts to various conditions, providing **thermal comfort** and **energy saving**.

HIGH EFFICIENCY & ECO-FRIENDLY

The modulating EC motors of AXIL EC ensure **reduced energy consumption**, offering sustainable and economical heating.

QUIET OPERATION

Speed modulation and new plastic propellers ensure **low noise levels**, taking thermal comfort to new heights.

Heat your spaces with tranquility.



Heating

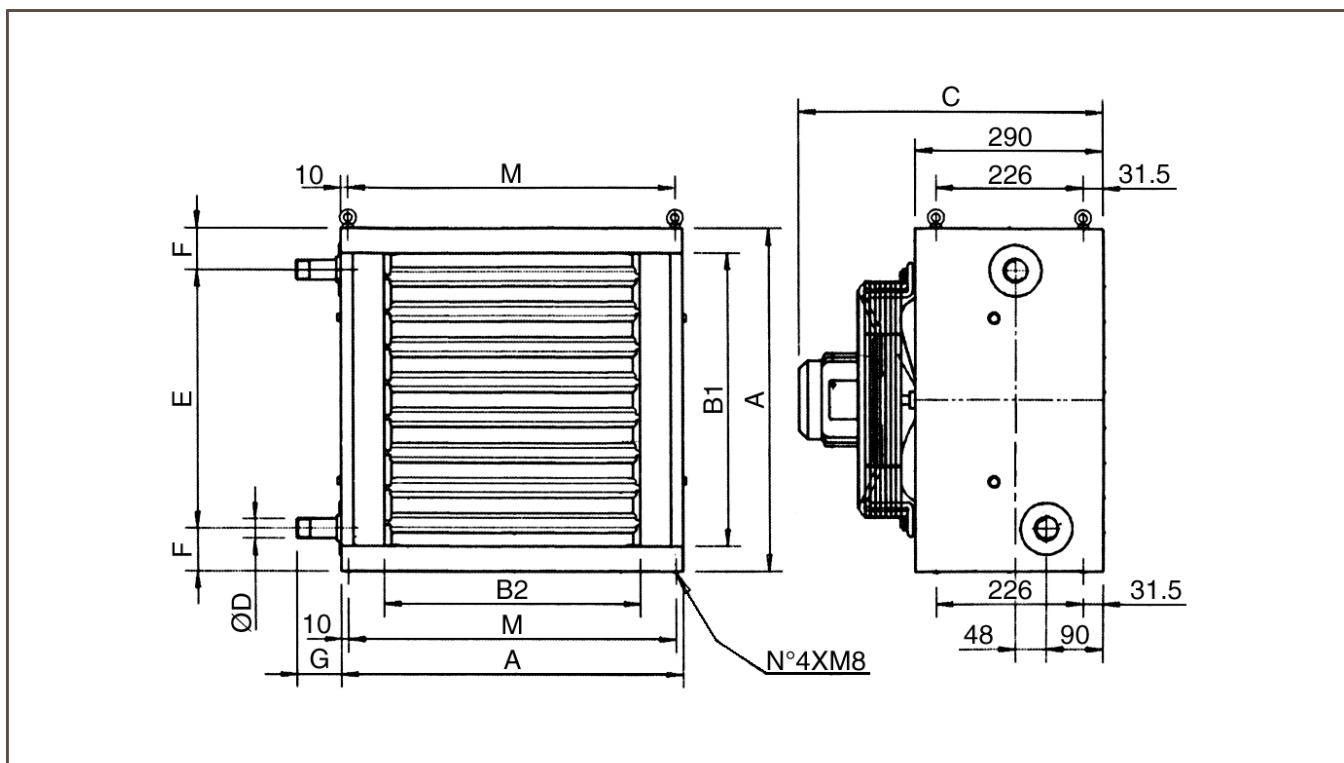

Dimensions

Model		AXIL EC 402/402/403	AXIL EC 502/503/504	AXIL EC 602/603/604	AXIL EC 902/903/904
A	mm	526	636	743	1011
B1	mm	450	550	641	885
B2	mm	394	500	610	875
C	mm	495	500	510	575
ØD	"	1	1	14	12
E	mm	397	497	588	832
F	mm	64,5	69,5	77,5	89,5
G	mm	69,0	69,0	60,0	91,5
M	mm	506	616	723	991

Weight and water content

Model		22	23	24	42	43	44	62	63	64	92	93	94
Weight	kg	24,0	25,0	26,0	31,0	32,5	34,0	41,0	42,5	44,5	72,5	77,0	81,0
Water content	l	1,3	1,7	2,2	1,9	2,7	3,4	2,9	4,0	5,1	5,4	7,6	9,8

For full technical data pls. consult the Technical Document AGU.

Cooling and heating

(for working on cooling, use only up to 4 Vdc)

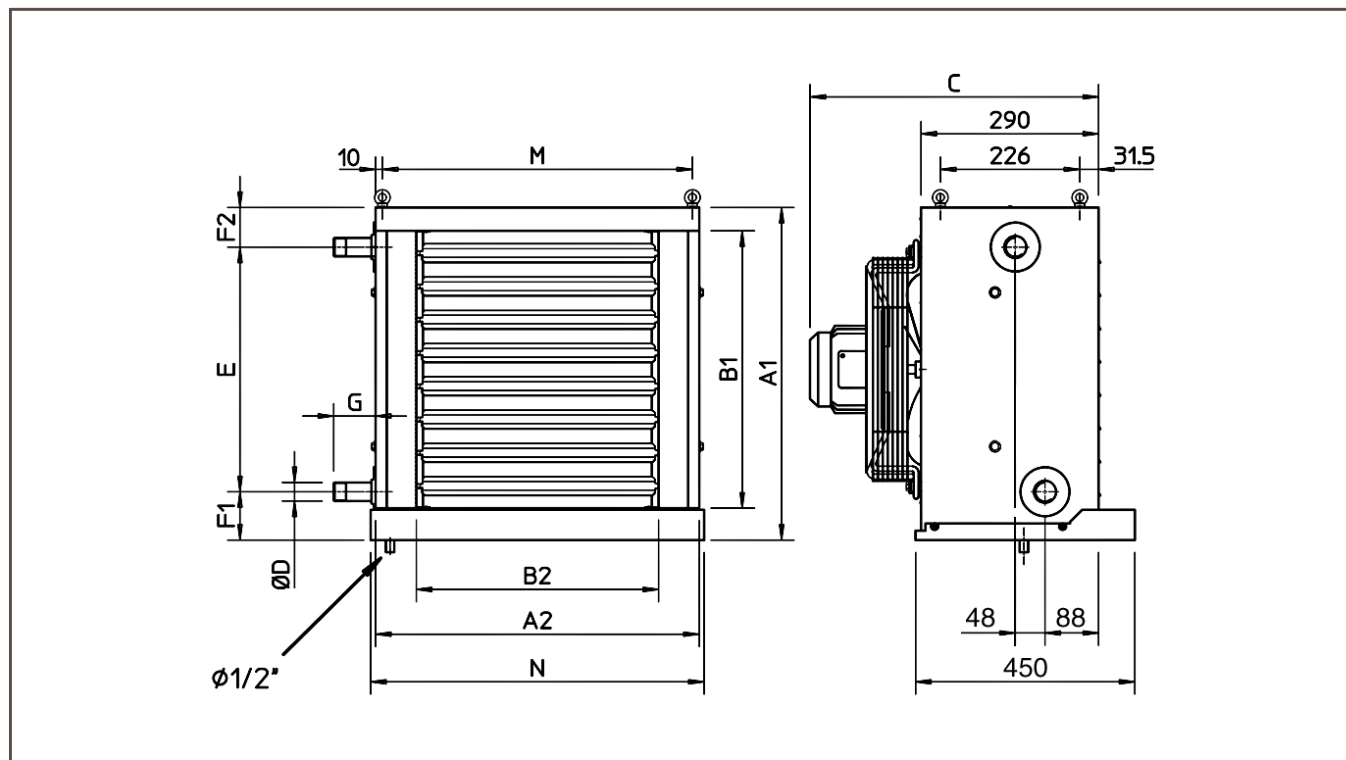

Dimensions

Model		2	4	6	9
A1	mm	537	647	754	1022
A2	mm	526	636	743	1011
B1	mm	450	550	641	885
B2	mm	394	500	610	875
C	mm	495	500	510	575
ØD	"	1	1	14	12
E	mm	397	497	588	832
F1	mm	75,5	80,5	88,5	100,5
F2	mm	64,5	69,5	77,5	89,5
G	mm	69,0	69,0	60,0	91,5
M	mm	506	616	723	991
N	mm	542	650	758	1026

Weight and water content

Model		23	24	43	44	63	64	93	94
Weight	kg	25,0	26,0	32,5	34,0	42,5	44,5	77,0	81,0
Water content	l	1,7	2,2	2,7	3,4	4,0	5,1	7,6	9,8

AIR HANDLING UNITS



Cleanair LX

209



AIR HANDLING UNITS

 AIR COOLED



Cleanair LX



 2 - 550 kW
 10 - 1300 kW
 1000 - 100000 m³/h





 Air/Air

 Cooling capacity

 Non food retail

 Hotels

 Heating capacity

 Shopping malls

 Industry

 Water/Air

 Airflow rate

 Office buildings

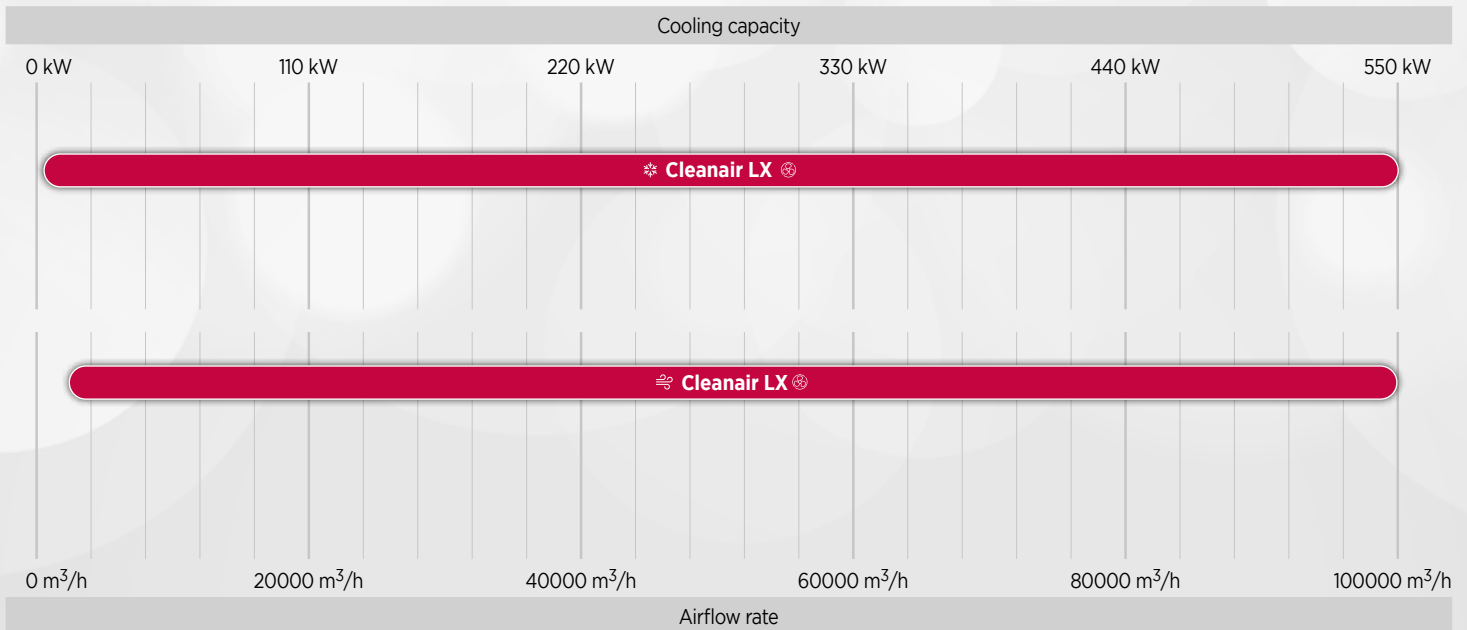

CLEANAIR LX

Modular air handling units



 2 - 550 kW
 10 - 1300 kW
 1000 - 100000 m³/h

- # Fully modular unit with 44 available sizes to provide **high flexibility** to any building design.
- # The **best choice** for any air treatment application: ventilation, filtration, heating, cooling, humidity control and heat recovery.
- # For indoor or outdoor applications, this **versatile** unit can operate with chillers, heat pumps, VRF or boilers.

HEAT RECOVERY

- # Plate heat recovery.
- # Wheel recovery.
- # Heat recovery systems with run-around coils.
- # Heat pipe heat recovery.



CASING & DESIGN

- # 60mm sandwich panels, insulated with injected polyurethane or mineral wool.
- # Smooth internal surface suitable for hygienic applications.
- # Pre-painted panels built with Galvanised or Stainless steel A304.
- # Aluminium profiles with natural finish or anodised.
- # Robust base with 150mm frame built with Galvanised or Stainless steel A304 with specific reinforced corners with lifting holes.
- # Condensate drain pans in aluminium or stainless-steel. As an option, it can be inclined to ensure complete drainage.
- # Aluminium alloy perimetral rain shelter suitable for outdoor unit applications, with PVC joint covers and man-safe covers on all angles (as an option).

AIRFLOW

- # Fan available in double inlet forward, backward, air foil blades or plug-fan and EC plug fan.
- # As an option single fan with double motor or double fan 100% with isolation dampers.
- # Several available airflow configurations: top, bottom or horizontal, to fit each building's needs.
- # Aluminium dampers provided with nylon gears optionally supplied with manually operated control or suitable linkages for motorised control application.

CONTROL

This range can be delivered with full control managed by CAREL controller – with communication possibility in common protocols:

- ModBus®
- BACnet®
- TCP/IP – SNMP
- TREND

CLIMATIC60



AIR TREATMENT

Filters available from G3 to H14:

- Medium efficiency flat filters
- Medium efficiency bag filters (loose or rigid)
- Medium efficiency roll filters
- High efficiency bag filters (loose or rigid)
- HEPA filters
- Activated carbon filters

Droplet eliminators, in several materials

- Drain pan: Peraluman or stainless steel
- Droplet eliminator: Polypropylene, Aluminium, SS304 or Galvanised steel

Several Humidifiers available:

- adiabatic, recirculated, steam generators, atomised water, air washers with single or twin spray nozzle bank.

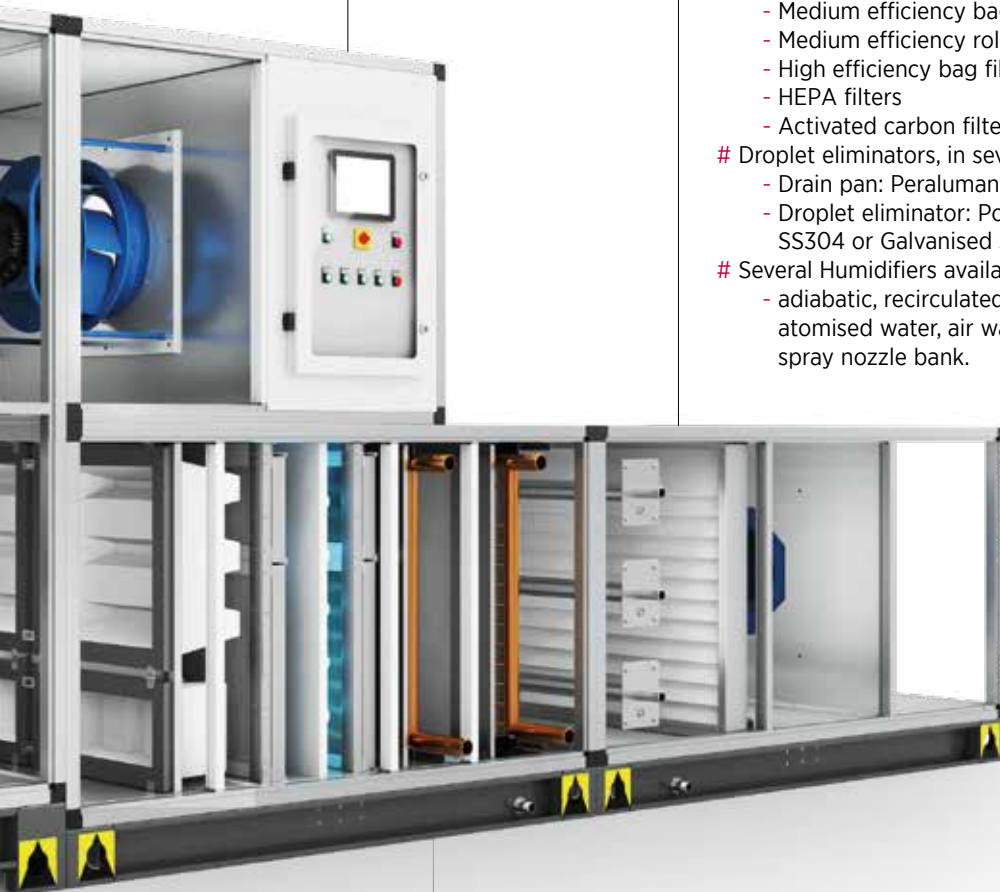
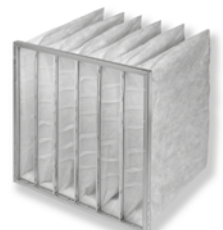

COILS

- # Several materials available: Cu/Al, Cu/AlPr, Cu/Cu, Cu/CuSn, Fe/Al
- # Water coils for chiller/heat pump applications.
- # Direct expansion coils for VRF applications.
- # Steam coils for boiler applications.
- # Electric coils supplied with safety thermostat with manual reset.

NEOSTAR

FC/FI NEOSTAR / V-KING

Air cooled condensers and dry-coolers



NEOSTAR

|||| 18 - 1280 kW

V-KING

|||| 50 - 2200 kW

FC/FI NEOSTAR

|||| 20 - 1200 kW

Versatile ranges available in multiple versions with thousands of models to suit any project and building requirement: **optimised efficiency, quiet operation** and **compactness**.

SOLUTIONS FOR ALL APPLICATIONS

- # **NEOSTAR**: remote air cooled condenser with flat coil design and low noise fans that allows perfect integration in urban environments.
- # **FC NEOSTAR**: flat dry cooler with compact and highly efficient coils.
- # **FI NEOSTAR**: flat dry cooler that operates with low pressure drop and high capacity, ideal for industrial applications.
- # **V-KING**: very powerful V-shaped dry cooler, with a smaller footprint than a flat model.



CASING & DESIGN

- # Casing made of white pre-painted galvanized sheet steel (NEOSTAR & FC/FI NEOSTAR) and epoxy painted metal structure (V-KING) for maximum corrosion resistance.
- # Fans arranged in line or in parallel, on both NEOSTAR and V-KING ranges:

FC/FI Neostar:



In line configuration



Parallel configuration

V-King:



In line configuration

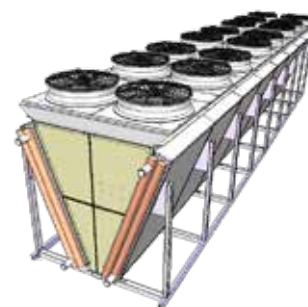

Parallel configuration

VENTILATION

- # The NEOSTAR & FC/FI NEOSTAR ranges are equipped as standard with two-speed external rotor motor fans (triangle and star coupling).
- # EC motor fans enabling speed variation and reducing the energy consumption are available as an option.
- # Available with 800 and 910mm diameter fans.



COILS

- # Aluminium fins with 1.9 mm (NEOSTAR, FC NEOSTAR, V-KING VC) or 2.12 mm (FI NEOSTAR, V-KING VI) spacing.
- # Combined with staggered copper tubes, the coils are very efficient and compact.

NOTES

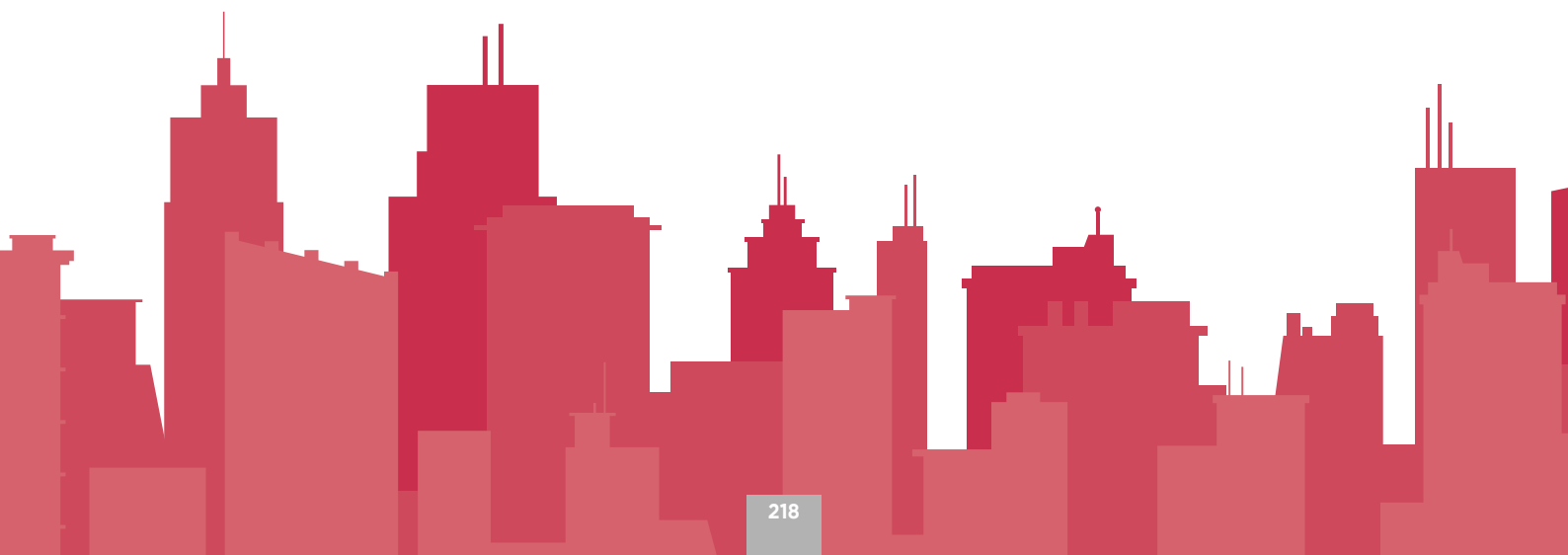

LennoxCloud

Multi-site & multi-unit connectivity solution



- # **Convenience** through remote monitoring: the units' performance data is accessible from the comfort of the office.
- # 24/7 monitoring ensures the units' **reliability** and provides building operators with **peace of mind**.
- # The units' performance optimisation leads to **reduced energy consumption and operating costs**.
- # Evaluate **savings on each maintenance procedure** by using real time collected data.
- # **Ensure comfort** in any season with automatic management of CO₂ levels⁽¹⁾ and humidity⁽²⁾.



USER-FRIENDLY DASHBOARDS

- # The **SITE DASHBOARD** gives a complete overview of the site, presenting monthly or yearly performances, alarm history and energy consumption⁽³⁾ of all installed units.
- # The **UNIT DASHBOARD** allows an overview of a single unit, presenting graphs with the history of indoor and outdoor temperature variations, CO₂ level⁽¹⁾ and relative humidity⁽²⁾ in the supply air stream and energy consumption⁽³⁾ for a specific period.

EXPERT ANALYSIS

- # Thanks to the analysis of the collected data, the Lennox experts will provide the end-users with quarterly reports and recommendations on how to optimise the system's performance and energy consumption⁽³⁾.

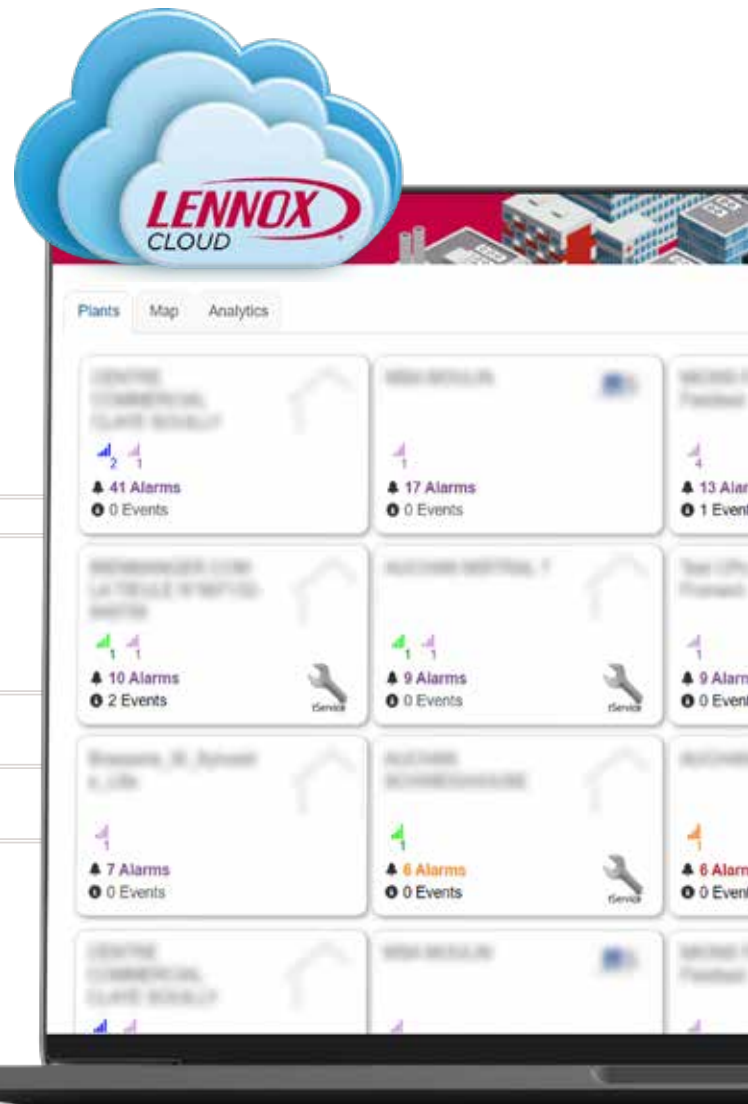

(1) Require Air Quality Sensor (CO₂) - optional feature on rooftops.
 (2) Require Humidity Control Pack - optional feature on rooftops.
 (3) Require Electric Energy Meter - optional feature on rooftops, chillers and heat pumps.

EASY MONITORING & CONTROL

Specifically designed for end-users, the **eDisplay** allows:

- # Remote access from any web browser.
- # Intuitive adjustment of the system's setpoints:
 - Room temperature.
 - Room temperature set points.
 - Indoor CO₂ levels⁽¹⁾.
 - Indoor humidity levels⁽²⁾.
 - System ON or OFF button.
 - External temperature.
 - Adjust settings.
 - Adjust time schedule.
 - Fan status.
 - Time schedule status.



LennoxCloud is available as an option on all units.

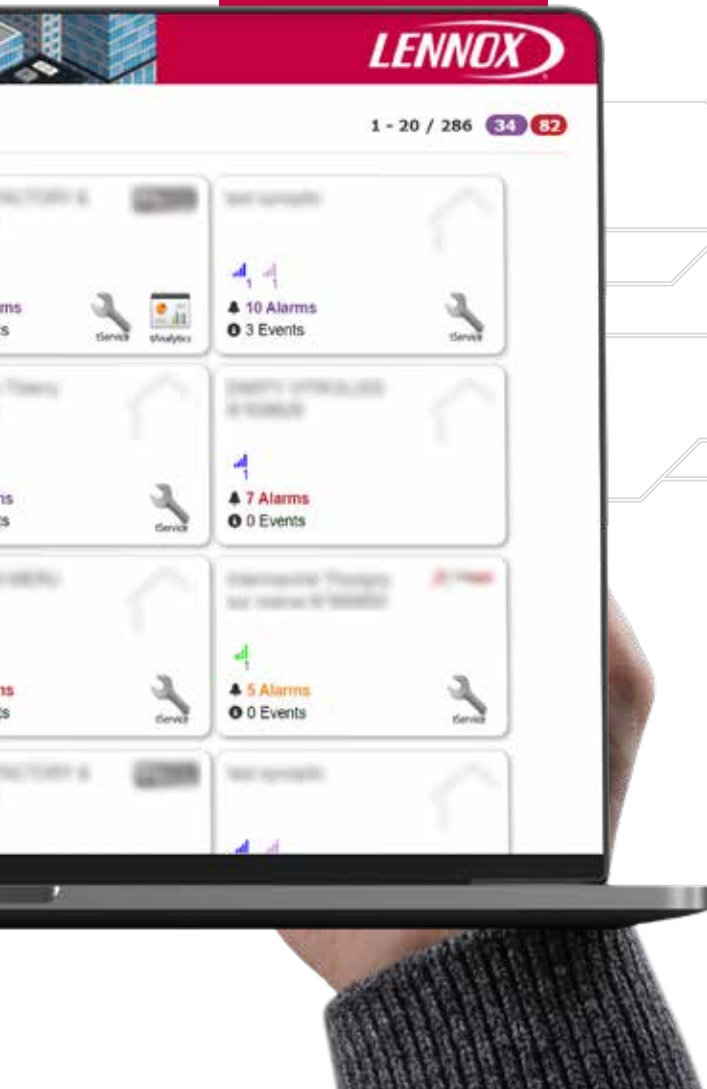

IMPROVED RESPONSIVENESS

- # The alarm log allows easy identification of critical issues and enables speedy action on them, thus reducing downtime.
- # Email notifications are sent when high level alarms are activated.



EXTENDED UNITS' LIFESPAN

- # The permanent monitoring enables the optimisation of the units' performance and increases their lifespan.

NOTES

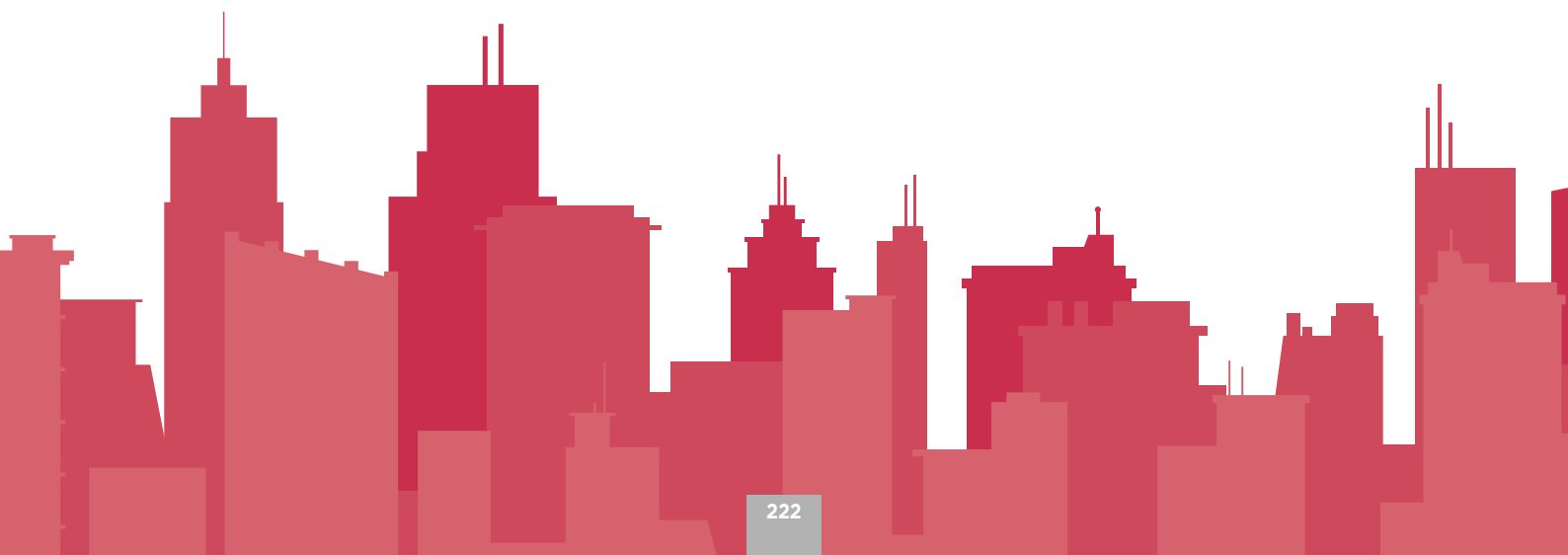

e-savvy

Smart building management system



- # Interoperable Monitoring System
- # Intercative, intuitive and evolutionary
- # Optimisation of Energy Consumption
- # Management of load shedding signals
- # Easy implementation and use



GENERAL DESCRIPTION :

- # **e-savvy** is an innovative solution from Lennox for the monitoring and management of HVAC systems.
- # Thanks to its intuitive man machine interface, e-savvy allows you to monitor in real time the status of all the devices. The interactive system allows the modification of several parameters such as settings and schedules of each area and to follow the trends.
- # e-savvy is a connected system able to send alerts in real time to it's users.
- # e-savvy is a simple, intuitive and user friendly tool allowing the zoning and the creation of several schedules in order to closely follow the needs of its end users.

CUSTOMER BENEFITS :

- # Compatible with Climatic 60 and eClimatic from Lennox
- # Electrical load shedding function (stop, 50% and 100% capacity)
- # Very easy to install, it is compatible with several devices such as tablets and PC computers
- # Alarm function by mail



Configuration and specifications	
Processor	ARM Cortex A7 dual core @1GHz
RAM	1 (up to 2) GB DDR3
Onboard flash	8 (up to 32) GB
Internal memory	Up to 128 GB microSDHC
Ethernet	1x Gbit Ethernet (RJ-45) + 1x Fast Ethernet [10/100 Mbps] (RJ-45)[10/100 Mbps] (RJ-45)
Operating	Temperature Range -5°C to 50°C (or 0-50°C if battery operated), RH range 5%- 55% not condensing
Power supply	12VDC@2A

Connectivity	
Wifi	802.11b/g/n with internal antenna (802.11ac optional)
Inputs	
	4 digital pulsed entry
	2 inputs Dry Contact
	4 programmable ports analogix, digital converters
	3 inputs for RTD sensors (PT100 or PT1000 selectable via DIP-switch)
	2+2 digital inputs/outputs

A smart, evolutionary and connected system designed to simplify your life.

NOTES

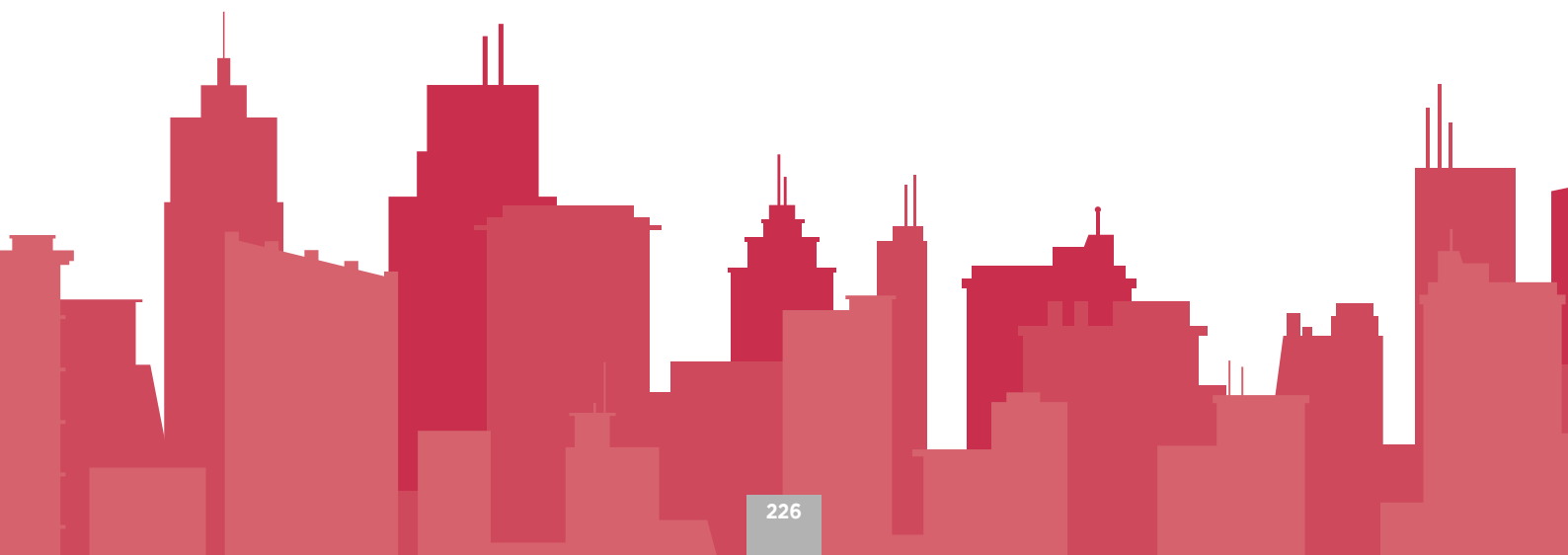

STAY TUNED!

DON'T MISS ANY INFORMATION

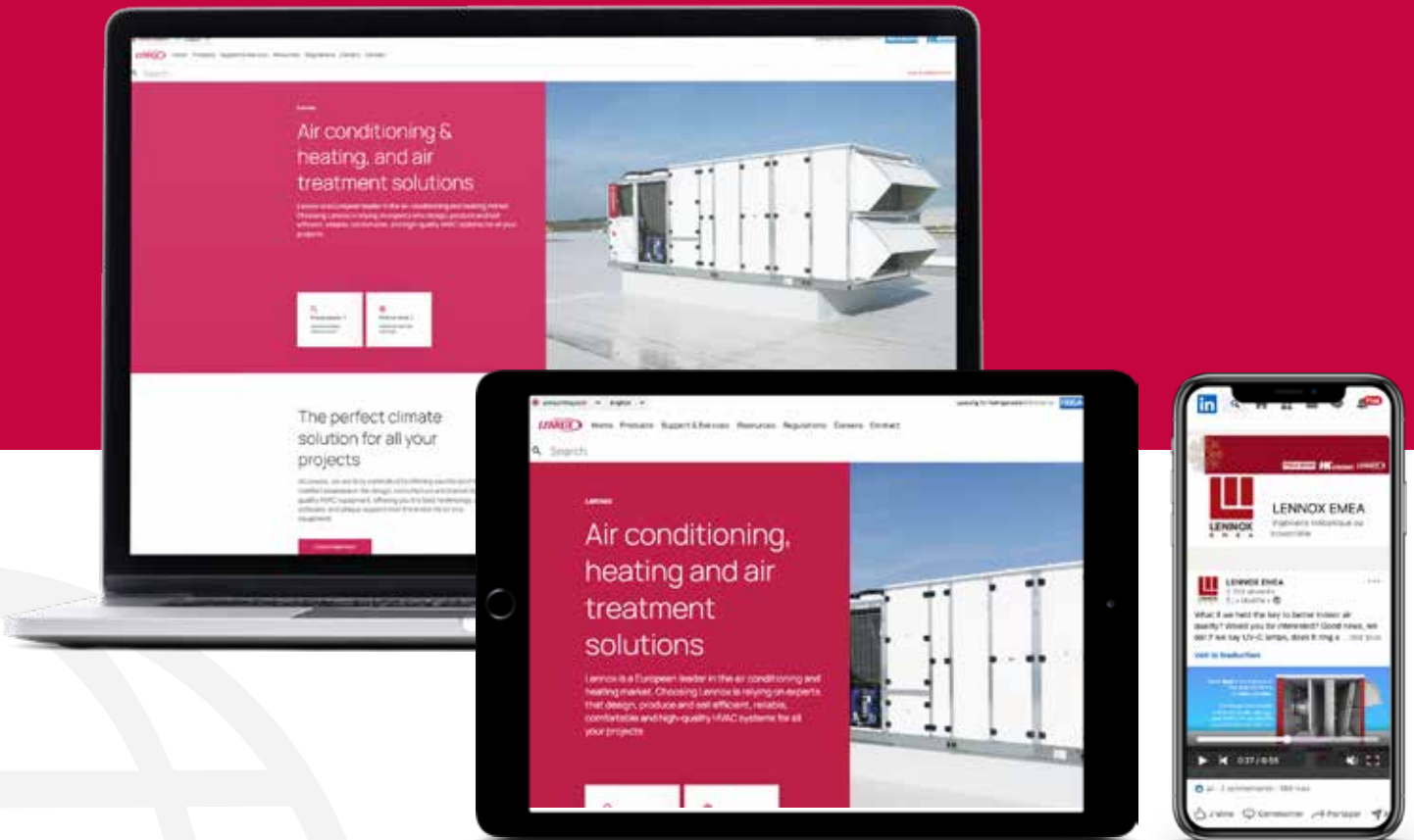

 www.lennoxemea.com

 www.linkedin.com/company/lennox europe

LENNOX EMEA

Hope Park Business Centre
Bradford, BD5 8HH
United Kingdom
+44 1604 669100
info.uk@lennoxemea.com

Watergoorweg 87
3861 MA Nijkerk
The Netherlands
+31 33 2471800
info.nl@lennoxemea.com

www.lennoxemea.com

